

cy # 2

NAVSHIPS 93742

(Non-Registered)

TECHNICAL MANUAL

93742

for

TELEGRAPH REPEATER,
MODEL TH-42/UG

93742
0967-553-8010
and

STELMA, Incorporated
200 Henry Street
Stamford, Connecticut

SHORE ELECTRONICS DEPARTMENT
LIBRARY

DEPARTMENT OF THE NAVY
BUREAU OF SHIPS

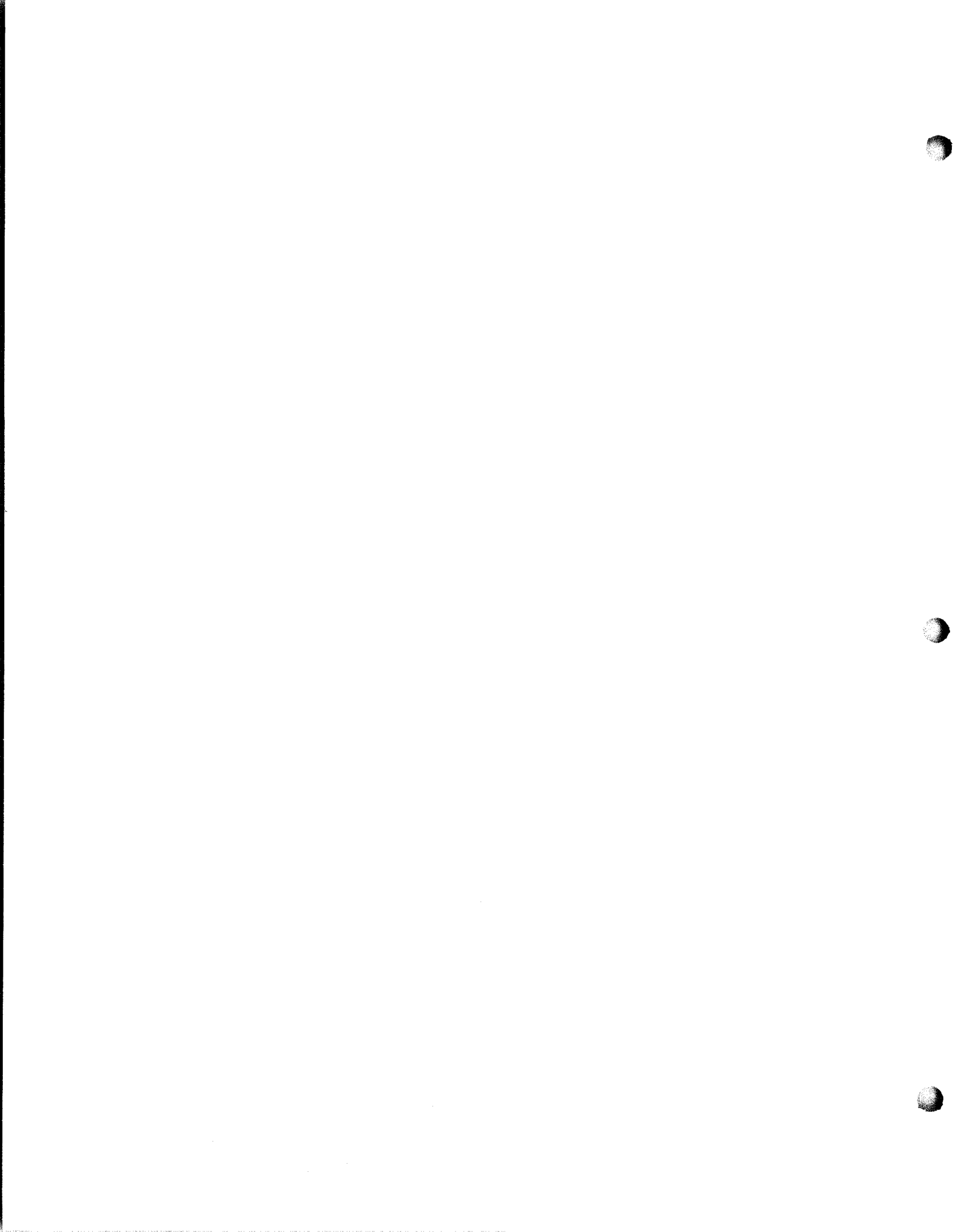

TABLE OF CONTENTS

SECTION 1. GENERAL INFORMATION

Paragraph		Page
1-1	Scope	1-1
1-2	Purpose	1-1
1-3	General Description	1-1
1-4	Technical Characteristics	1-1

SECTION 2. INSTALLATION

2-1	Unpacking	2-0
2-2	Installation	2-0
2-3	Loop Connections	2-0
2-4	Initial Adjustments and Checks	2-1

SECTION 3. OPERATOR'S SECTION

3-1	General	3-0
3-2	Capabilities and Limitation	3-0
3-3	Operation of Each Function	3-1

SECTION 4. PRINCIPLES OF OPERATION

4-1	General	4-0
4-2	Circuit Function	4-0

SECTION 5. OPERATOR'S MAINTENANCE

5-1	Routine Checks	5-0
5-2	Emergency Maintenance	5-0

SECTION 6. PREVENTIVE AND CORRECTIVE MAINTENANCE

6-1	Routine Maintenance	6-0
6-2	System Troubleshooting	6-0
6-3	Repeater Troubleshooting and Repair	6-1
6-4	Replacement of Parts	6-1
6-5	Adjustment of Controls	6-3

SECTION 7. PARTS LIST

7-1	General	7-0
-----	---------	-----

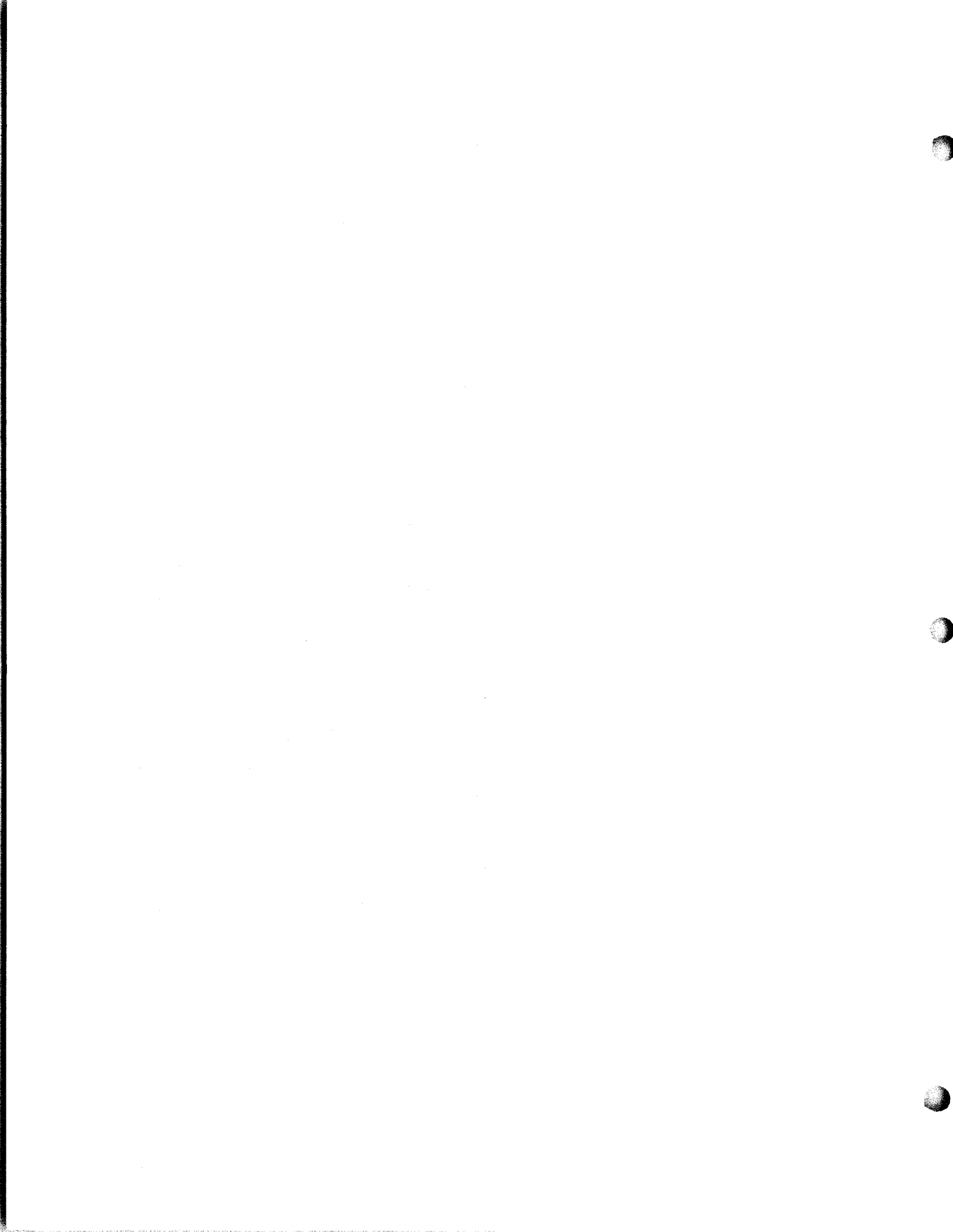

LIST OF ILLUSTRATIONS

SECTION 1. GENERAL INFORMATION

Figure		Page
1-1	Telegraph Repeater, Model TH-42/UG	1-0

SECTION 2. INSTALLATION

2-1	Telegraph Repeater, Model TH-42/UG, Connections to loops.	2-1
-----	--	-----

SECTION 4. PRINCIPLES OF OPERATION

4-1	Telegraph Repeater, Model TH-42/UG, Schematic.	4-1
-----	---	-----

SECTION 6. PREVENTIVE AND CORRECTIVE MAINTENANCE

6-1	Telegraph Repeater, Model TH-42/UG, Inside View	6-2
6-2	Telegraph Repeater, Model TH-42/UG, Terminal Board Components	6-4

Figure
1-1

NAVSHIPS-93742

TH-42/UG
GENERAL INFORMATION

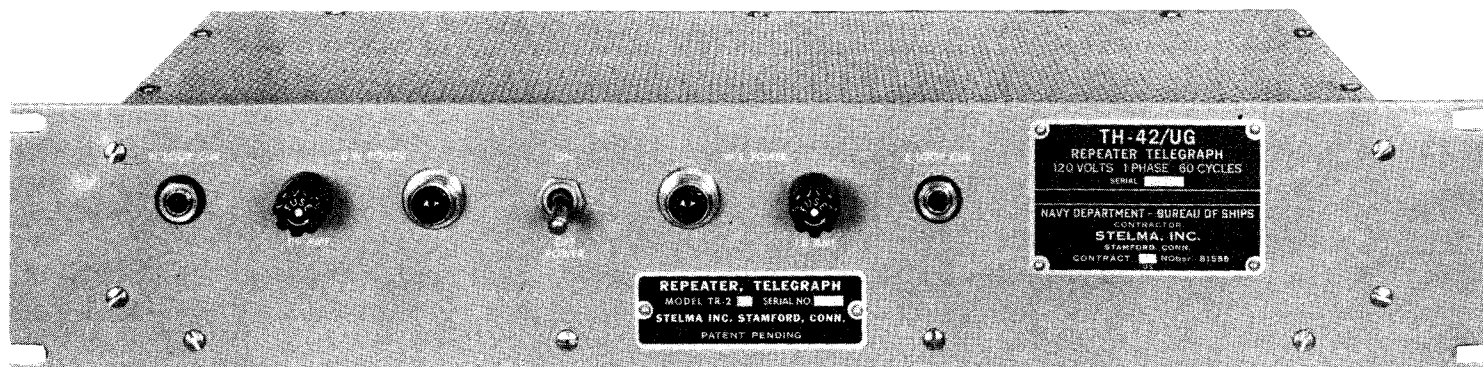

FIGURE 1-1 TELEGRAPH REPEATER. MODEL TH-42/UG

SECTION 1

GENERAL INFORMATION

1-1. Scope

This publication describes the installation, operation, theory of operation, and operator's, preventive and corrective maintenance for Telegraph Repeater TH-42/UG, STELMA Model TR-2B (fig. 1-1), hereafter referred to as the Repeater.

1-2. Purpose and Use

a. The Repeater is an in-line device, designed for 1-way reversible operation; it may also be connected for 4-wire (4W) to 4-wire or 2-wire (2W) to 4-wire operation. The unit is fully electronic, and its input and output circuits are isolated from one another. It is adaptable to either 20-ma or 60-ma neutral telegraph loops.

b. The Repeater uses tone couplers for isolation on the input sides, and low resistance vacuum tube keying on the output sides; all its circuits float from chassis. For in-line, 2-wire service, the two 1-way repeaters that make up the unit are operated with input of one connected in series with the output of the other. Electronic coupling is provided between the two 1-way repeaters, so that: (1) the output keying tube on one repeater, in series with the input circuits of the other repeater, is continuously on mark during transmission; and (2) an open circuit at the receiving end puts the sending end on space.

1-3. General Description

The Repeater is constructed with a 3-1/2 inch by 19 inch panel for rack mounting; the equipment extends 10 inches behind the panel, with tubes and transistors available at the back of the chassis for convenient access. A terminal strip at the rear provides all loop connections to the repeater.

1-4. Technical Characteristics

Function	Description
WEIGHT	12 pounds
TYPE OF LOOP	20-ma or 60-ma neutral.

Paragraph
1-4

NAVSHIPS-93742

TH-42/UG
GENERAL INFORMATION

EFFECTIVE MARK INPUT OR OUTPUT IMPEDANCE	425 ohms ($\pm 5\%$)
FOUR WIRE SERVICE (Per Loop); Input	270 ohms, 20-ma loop; 90 ohms, 60-ma loop.
Output	330 ohms, (mark).
KEYING SPEED	Up to 150 cps (300 baud).
DISTORTION	Under 2%
TUBE COMPLEMENT	4-5963 2-5687
TRANSISTOR COMPLEMENT	2-2N64
POWER REQUIREMENTS	105-125 volt ac, 50/60-cps, single phase, 50 watts.

SECTION 1

GENERAL INFORMATION

1-1. Scope

This publication describes the installation, operation, theory of operation, and operator's, preventive and corrective maintenance for Telegraph Repeater TH-42/UG, STELMA Model TR-2B (fig. 1-1), hereafter referred to as the Repeater.

1-2. Purpose and Use

a. The Repeater is an in-line device, designed for 1-way reversible operation; it may also be connected for 4-wire (4W) to 4-wire or 2-wire (2W) to 4-wire operation. The unit is fully electronic, and its input and output circuits are isolated from one another. It is adaptable to either 20-ma or 60-ma neutral telegraph loops.

b. The Repeater uses tone couplers for isolation on the input sides, and low resistance vacuum tube keying on the output sides; all its circuits float from chassis. For in-line, 2-wire service, the two 1-way repeaters that make up the unit are operated with input of one connected in series with the output of the other. Electronic coupling is provided between the two 1-way repeaters, so that: (1) the output keying tube on one repeater, in series with the input circuits of the other repeater, is continuously on mark during transmission; and (2) an open circuit at the receiving end puts the sending end on space.

1-3. General Description

The Repeater is constructed with a 3-1/2 inch by 19 inch panel for rack mounting; the equipment extends 10 inches behind the panel, with tubes and transistors available at the back of the chassis for convenient access. A terminal strip at the rear provides all loop connections to the repeater.

1-4. Technical Characteristics

Function	Description
WEIGHT	12 pounds
TYPE OF LOOP	20-ma or 60-ma neutral.

Paragraph
1-4

NAVSHIPS-93742

TH-42/UG
GENERAL INFORMATION

EFFECTIVE MARK INPUT OR OUTPUT IMPEDANCE	425 ohms ($\pm 5\%$)
FOUR WIRE SERVICE (Per Loop); Input	270 ohms, 20-ma loop; 90 ohms, 60-ma loop.
Output	330 ohms, (mark).
KEYING SPEED	Up to 150 cps (300 baud).
DISTORTION	Under 2%
TUBE COMPLEMENT	4-5963 2-5687
TRANSISTOR COMPLEMENT	2-2N64
POWER REQUIREMENTS	105-125 volt ac, 50/60-cps, single phase, 50 watts.

SECTION 2

INSTALLATION

2-1. Unpacking

The Repeater is packed in a heavy cardboard carton; no special instructions are required for unpacking. Upon removal, inspect the unit for damage. All tubes and transistors are in their sockets, and the unit is ready for installation.

2-2. Installation

a. Install the Repeater in a standard rack. No rack mounting hardware is supplied. One person must support the weight of the Repeater at the back of the rack while a second inserts the mounting screws.

NOTE

The rack should not have an internal ambient temperature greater than +60°C. The bottom of the rack is usually the coolest spot.

b. Connect the power cord and plug to a source of 115-volts, 50/60 ac power.

2-3. Loop Connectors

a. IN-LINE 2W OPERATION (Fig. 2-1).

(1) Wire the E loop to the 2WE terminals, observing proper polarity.

(2) Wire the W loop to the 2WW terminals, observing polarity.

(3) Insure that a jumper is connected between the 4WSA- and the 4WRA+ terminals.

(4) Insure that a jumper is connected between the 4WSB- and the 4WRA+ terminals.

(5) Observe that the negative side of the loop connects to the plus terminal of the 2-wire Repeater connection; this is because connection is made through the Repeater circuits to the negative side of the battery.

Figure
2-1

NAVSHIPS-93742

TH-42/UG
INSTALLATION

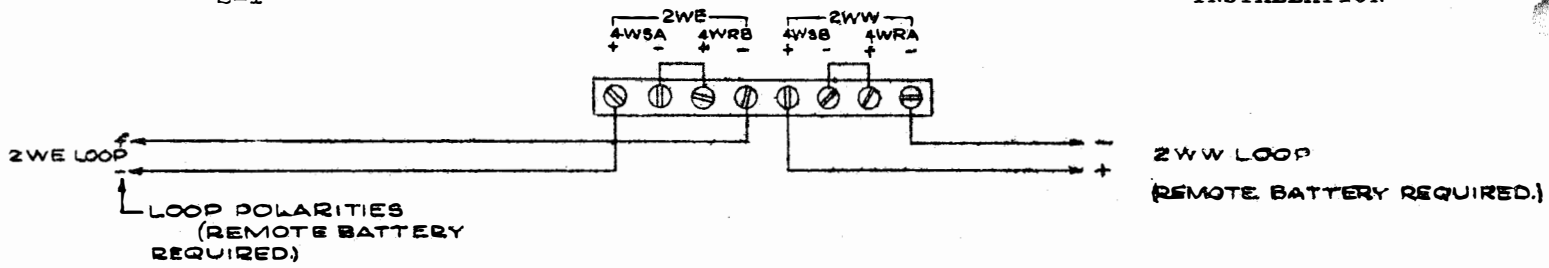

A TWO-WIRE IN LINE OPERATION.

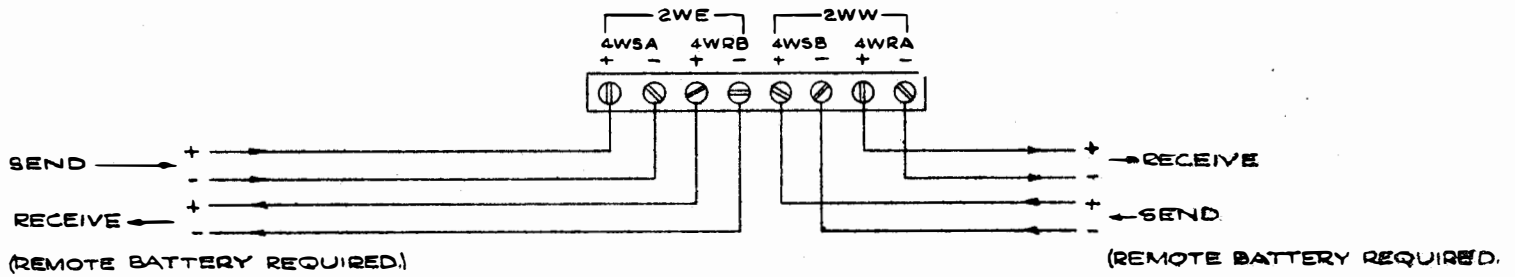

B FOUR WIRE OPERATION

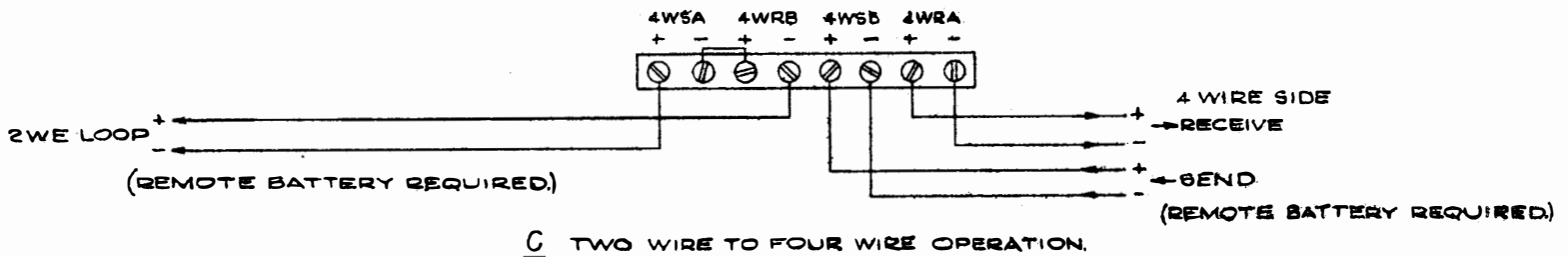

C TWO WIRE TO FOUR WIRE OPERATION.

FIGURE 2-1 TELEGRAPH REPEATER. MODEL TH-42/UG

CONNECTIONS TO LOOPS.

b. 4W to 4W or 2W OPERATION. (Fig. 2-1).

(1) Remove jumper between 4WSA- and 4WRB+ terminals. Remove jumper between 4WSB- and 4WRA+ terminals. (The designation 4WSA refers to the sending end of the loop; 4WRA refers to the receiving end of a loop. Input to a Repeater is from a send loop; output from a Repeater goes to a receive loop.)

(2) Make connections as shown in figure 2-1, observing polarity.

(3) Remove cover of Repeater, and locate capacitors C16 and C17.

(4) Remove one end connection of each capacitor from terminal tie point, leaving capacitor supported at other end by transformer connection.

c. 2W to 4W OPERATION.

(1) Remove jumper between 4WSB- and 4WRA+ terminals.

(2) Make connections as shown in figure 2-1.

NOTE

Do not remove capacitors C16 or C17.

d. CONNECTIONS FOR 20-MA or 60-MA LOOPS. If the Repeater, which comes connected for 60-ma loops, is to be used on 20-ma loops, remove the jumpers across the terminals marked "JUMP FOR 60 MA". There are two such jumpers, one for the 4WSB or 2WW circuits.

2-4. Initial Adjustments and Checks

a. When installing the unit in the rack, check that all tubes and the two transistors are properly seated in their sockets.

b. Set the panel POWER switch to ON, and check that the two pilot lamps light (one lamp for each of the two Repeater power supply circuits).

c. Check that all the tubes in the Repeater light.

d. Check that all connections are correct (par. 2-3).

e. Connect a milliammeter (0-100 ma) to the W LOOP CUR. jack on the panel, using a plug with positive circuit connection on the tip. Adjust-loop current for exactly 60 (or 20) ma.

f. Connect milliammeter to the E LOOP CUR. jack, and proceed as outlined in Step e., above, to adjust E loop current.

NOTE

If current in either loop is too low, this may reflect a space or too low current in the other loop. Therefore, after any current adjustment in E or W loop, the current in the other loop should be checked until both loops have the correct marking current.

g. For 4-wire operation, the W LOOP CUR. jack provides measurement in the 4WRA loop, and the E LOOP CUR. jack provides measurement in the 4WRA loop. Current measurements in the 4WSA and 4WSB loops must be made at other points in the loop.

h. After currents are checked in all loops, an initial check of operation should be made by sending traffic from E to W and then from W to E. Failure to obtain proper copy of traffic in either direction should be considered as trouble, and Section 6 should be consulted.

SECTION 3

OPERATOR'S SECTION

3-1. General

a. Upon installation (par. 2-2), operation of the Repeater is automatic. Assuming that the loop currents have been checked (par. 2-4) and that the marking condition exists in both E and W loops, either side may transmit immediately to the other side. As soon as traffic has stopped in one direction, it may start in the other direction. If traffic is proceeding in one direction, the receiving side may open its loop to cause the "home copy" teleprinter at the transmitting side to run open, as a signal that the receiving side has an urgent message and wants to break in. In this case, the transmitting end should close its transmitting circuit, in preparation for receiving a message. When the receiving end loop is closed again, marking condition should result; continued reception of traffic indicates that the receiving end has not signaled the sending end, and therefore, the receiving end loop must be opened again to space for signaling.

b. To power the Repeater, turn POWER switch to ON. (When the switch is pushed down, Repeater power is off.)

3-2. Capabilities and Limitations

a. Although the Repeater handles high-speed signals (such as those supplied by time division multiplex equipment), it is recommended that the Bias Correct control be checked for proper adjustment at these speeds as outlined in Section 6. The telegraph loop circuit characteristic must be suitable for these speeds; otherwise, the Repeater will not operate properly.

b. The Repeater, which is designed for continuous operation, normally requires only tube replacement when a tube burns out or becomes defective. Changing tubes V1 or V4, or transistors Q1 or Q2 may necessitate a check or re-adjustment of the Bias Correct Variable Resistor R4 (or R21). The Repeater should normally introduce less than 2% distortion to teletypewriter signals, even at high keying speeds.

c. Since the Repeater inputs are isolated from ground and from one another, the Repeater loops may be floating or grounded on either leg. If there is an option for grounding, it is recommended that the negative terminal of the 2W loop-connection to the Repeater be grounded, (this would be the 4WRB- and 4WRA- terminals for 4-wire service). See figure 4-1.

d. The Repeater is not designed to operate on polar telegraph circuits.

3-3. Operation of Each Function

a. The Repeater's primary function is to operate in either direction (1-way reversible) when inserted in a 2-wire telegraph loop, thereby regenerating loop current. This operation is purely automatic and requires no attention at the Repeater.

b. A secondary function of the Repeater involves the 4-wire option, wherein traffic may be carried on in both directions simultaneously, using four wires. Installation of the Repeater at the center of the loop produces two shorter loops, resulting in improved loop characteristics. Repeater operation is fully automatic.

c. The Repeater will perform a 2-wire to 4-wire conversion where traffic received from the 2-wire line is delivered to the 4-wire receive loop, and traffic sent on the 4-wire send pair is delivered to the 2-wire loop. When sending on the 4-wire send pair, the 4-wire receive pair is held on mark.

SECTION 4

PRINCIPLES OF OPERATION

4-1. General

a. Figure 4-1, a schematic of the 2-way Repeater, illustrates two Repeaters (one across the upper part, and the other across the lower part of the figure) which are identical in configuration and operation when in-line, 1-way, reversible operation is desired, the two 1-way electronic Repeaters are connected so that the input to one is in series with the output of the other. This is possible because the input of each repeater is isolated, from its output; transformers T1 and T4 perform the isolating function dc-wise. The output keying circuits, common to the cathode of V3 (or V6), are floating from ground, and a separate power supply is used for each single Repeater. Therefore, the input and output circuits of the 1-way reversible system are isolated, dc-wise, from one another and from ground.

b. When transmitting from E to W and a mark is keyed, the current in the input 2WW loop of the lower Repeater (fig. 4-1) keeps keying tube V6 in the E loop conducting. When a space is keyed from the 2WE line, oscillator V2B is keyed on by V1B, and the signal is applied via transformer T2 to the input of the lower Repeater, which keeps keying tube V6 conducting. Thus, V6 is continuously conducting on traffic from E to W. (Tube V3 is kept continuously conducting during transmission from W to E, in the same manner.)

c. If traffic is going from E to W and the W loop is opened, the first E-loop mark signal that occurs (after the W loop is opened) allows a lack of signal input from either source to be applied to the lower Repeater. This causes keying tube V6 in the lower repeater to go to space, and opens the E loop permanently until the W loop is again closed. Consequently, the W loop can signal the E loop during E-W transmission. Similarly, if traffic is proceeding W to E, the E loop may open its circuit, causing a steady space to appear at the W loop.

4-2. Circuit Function

Because the two Repeater circuits in figure 4-1 are identical, the following description of the upper Repeater is applicable to operation of the lower Repeater.

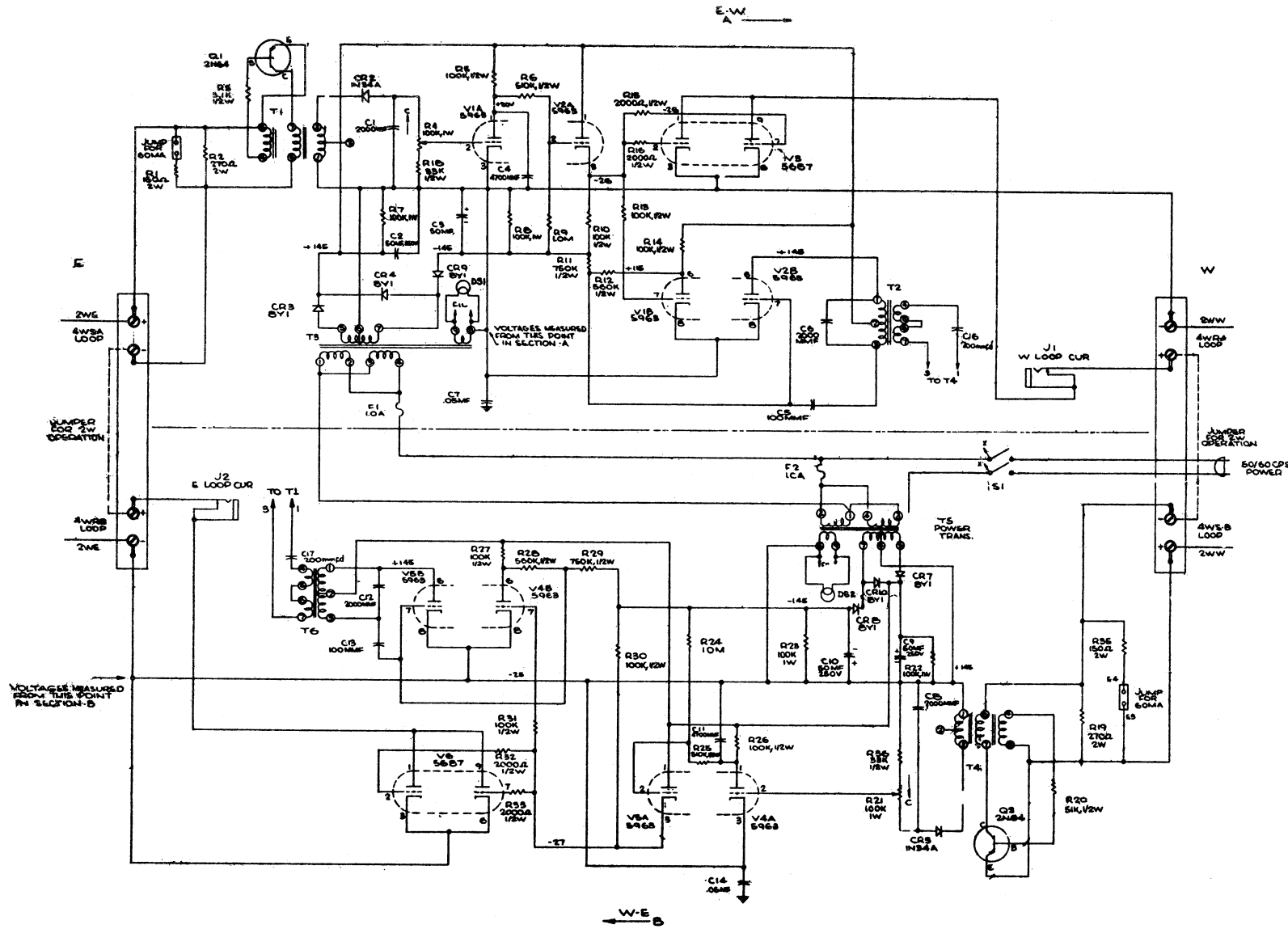

FIGURE 4-1 TELEGRAPH REPEATER, MODEL TH-42/UG

SCHEMATIC

FIGURE 4-1
TELEGRAPH REPEATER, MODEL TH-42/UG
SCHEMATIC

a. LOOP OSCILLATOR. Assuming transmission from E to W, the loop current produces a voltage drop across R2. This voltage is applied to transistor oscillator Q1, utilizing transformer T1 in a feedback circuit to produce a high audio-frequency oscillation. Crystal CR1 protects Q1 in case incorrect polarity is connected across 2WSA terminals. The secondary of T1 applies the tone signal to crystal rectifier CR2, where the signal is rectified to dc again and filtered by C1. Transformer T1 provides dc isolation between the E loop and the circuits connecting to terminal 3 of T1.

b. KEYING CIRCUITS. The dc voltage developed at the output of CR2 appears across variable resistor R4 and is applied to the grid of V1A to cut the tube off. As a result, the V1A plate potential is very positive, driving the grid of cathode follower tube V2A positive via resistor R6. As the cathode of V2A goes positive, it applies a positive voltage to the grids of output keying tube V3, via grid-current limiting resistors R15 and R16. Tube V3 conducts heavily, acting as a resistance (approximately 330 ohms from plate to cathode) in the W output loop. During space input to the E loop, Q1 does not oscillate, so that V1A conducts and its positive plate potential is reduced. This causes the voltage at the grid of V2A to go negative, driving its cathode negative. Consequently, the grids of V3 are biased off, producing space in the W loop. The switching action from M-S or S-M is a very rapid circuit action. Variable resistor R4 may be adjusted to secure zero bias in the output loop where a zero bias signal is fed into the input; the variable resistor is normally set in a clockwise position.

c. HOLDING CIRCUITS. The holding circuits utilize V1B and V2B to hold V6 conducting during a space signal from the E loop (par. 4-1, b.). When input to the E loop goes to space, tube V1A loses bias, causing conduction so that its plate goes negative, as do the grid and cathode of V2A; consequently, the grid of V1B is made negative via connection of R13 to the cathode of V2A. The plate of V1B goes positive, bringing the grid voltage of V2B from negative to the more positive level where V2B oscillates in a Hartley circuit using the primary of T2 as the tank inductor. Capacitor C6 tunes the circuit to about 15 kc, and C5 serves as a grid capacitor. Output from the secondary of T2 is applied, via coupling capacitor C16, to the secondary of T4 (terminals 1 and 3) where the signal, fed directly to CR5, is rectified to a negative voltage that biases V4A off, causing V6 to conduct in the same manner as a marking signal as the W loop does. The means of tone coupling from V2B to the input of CR5, using T2 again, permits dc isolation between the keying circuits of the W loop and the E loop.

d. POWER SUPPLY. The use of two power supplies in the Repeater allows isolation of circuits. Power transformer T3 supplies filament and positive and negative voltages for V1, V2, and V3. Rectifiers CR3 and CR4 provide a positive dc voltage which is filtered by C2 and used for the plate supply of V1 and V2. Rectifier CR5 provides a negative voltage, filtered by C3, that provides negative biasing potential for the tubes.

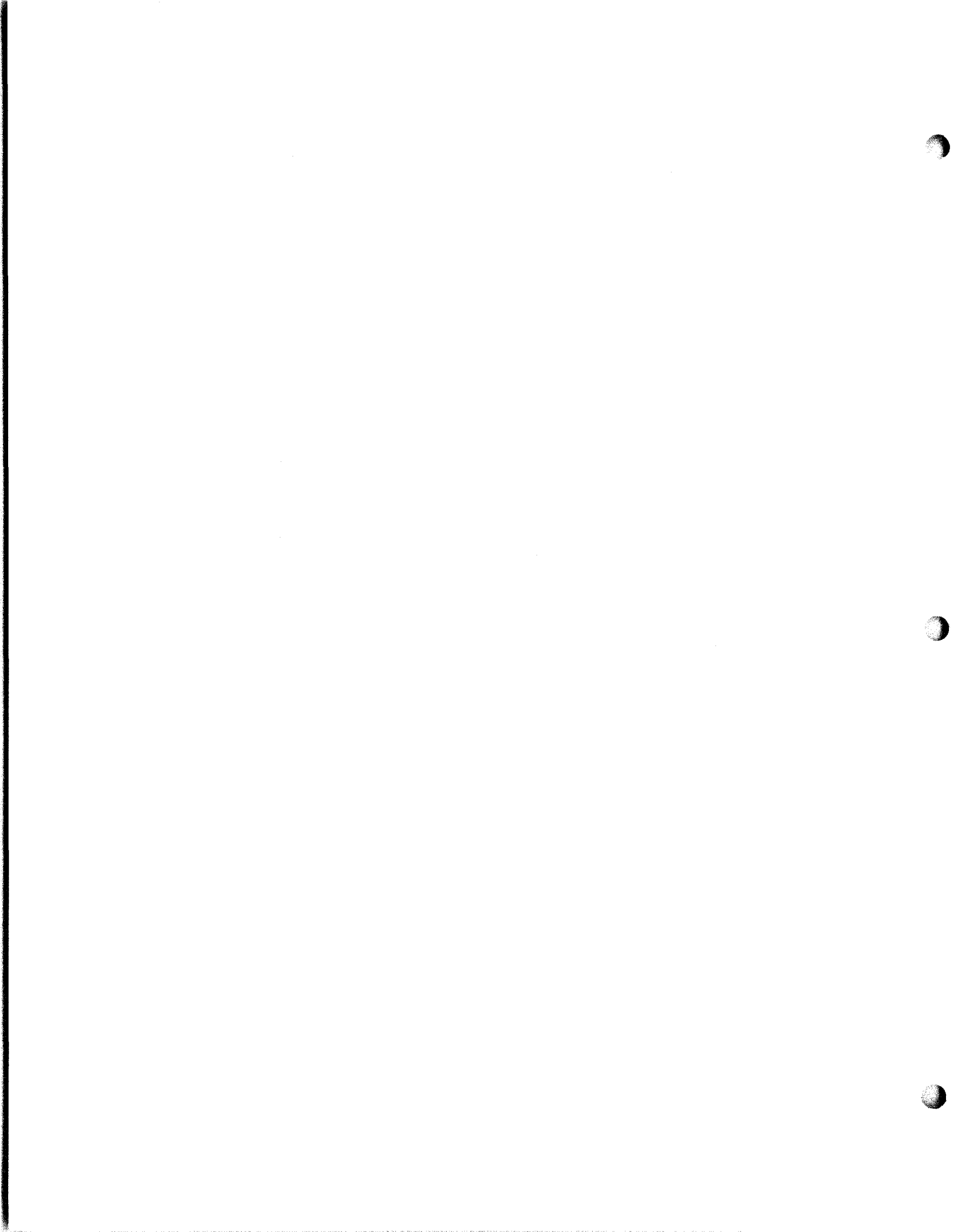

SECTION 5

OPERATOR'S MAINTENANCE

5-1. Routine Checks

Perform the following routine checks once a month and/or whenever the Repeater is suspected of malfunctioning.

a. Operate the Repeater, and check that it is able to transmit information in each direction.

b. Check that loop output current is correct (i.e., either 20 ma or ~~30~~ 60 ma) by measuring output at E and W LOOP CUR. jacks; adjust, if required, as described in paragraph 2-4.

c. With a signal applied, measure bias distortion at the E or W LOOP CUR. jacks, using a Telegraph Distortion Analyzer (such as the TS-917/GG); check that the two readings are approximately the same.

5-2. Emergency Maintenance

a. The operator may replace the appropriate panel fuse if the pilot lamp and tubes in either section of the Repeater do not light; check the pilot lamp to be sure it is good. The pilot lamp and fuse to the left of the POWER switch control the A section of the Repeater; this section's three tubes are at the right of the Repeater chassis (facing the back of the Repeater). The pilot lamp and fuse to the right of the POWER switch control the B section of the Repeater and the three tubes associated with this section are located at the center of the chassis at the rear.

b. Tubes in the Repeater may be replaced if they do not light when the Repeater is properly powered. If possible, test new tubes before inserting them into the Repeater.

c. The 2N64 transistors may also be replaced. In replacing these transistors, make sure that the leads are properly inserted in the sockets. Loosen the screw holding the bracket that supports the transistors, before turning the bracket, in order to permit removal of the transistors.

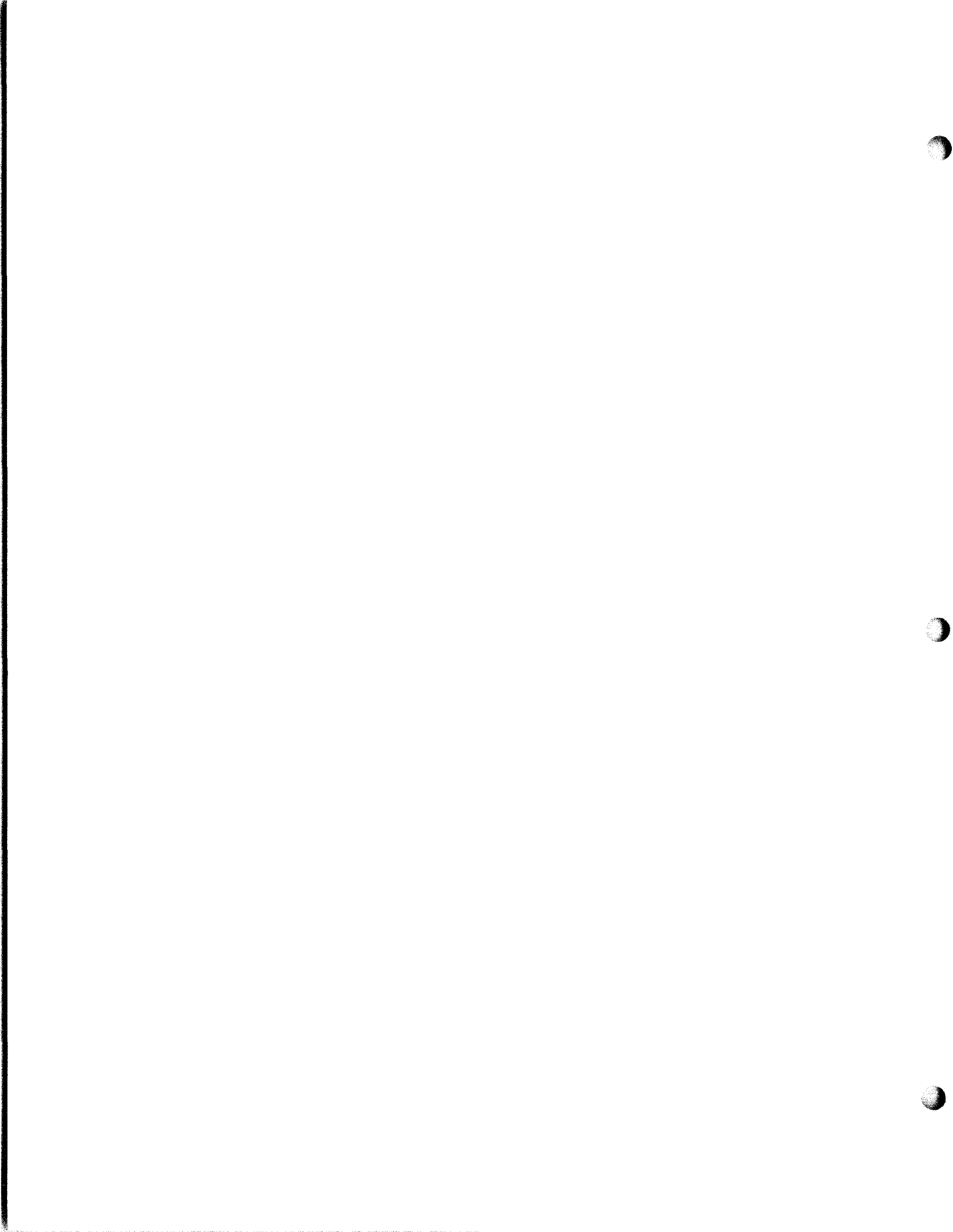

SECTION 6

PREVENTIVE AND CORRECTIVE MAINTENANCE

6-1. Routine Maintenance

a. Perform the checks listed in paragraph 5-1; to perform the one described in paragraph 5-1, c., use a signal source (into the Repeater) having low distortion, such as from a Teletype DDX4 (TS 383). The (TS 917/GG) should measure low bias on the receiving end. Make checks in both directions, sending with a source of low bias, and measuring the bias on the receiving side. Make this operational check at intervals of 3 months and/or whenever any difficulty is experienced.

b. Using a tube tester, check vacuum tubes once every three to six months, depending on whether the unit has been continuously or intermittently operated; replace tubes having low emission. Once a year, check 2N64 transistors, using a standard transistor tester; the transistors are of a Government approved type and should give long life.

c. Perform the following checks annually:

(1) Remove the Repeater from the rack, and remove the top plates;

(2) Visually check all components for any sign of overheating or deterioration. Look for excessively darkened resistors and check all components and capacitors, and transformers that have bulged at the sides or have leaked wax. Replacement need not be made unless values of components have changed or unless operation of the unit is improper and the suspected component is observed to smoke, emit wax, overheat, etc. after the unit has been in operation for an hour.

6-2. System Troubleshooting

In system troubleshooting, make checks with all circuits in operation: transmitting a signal from one terminal over a line to the Repeater, and then over a second line to a second terminal. Perform the check described in 5-1, b., before proceeding to the system troubleshooting below.

a. Check the quality of the signal at the output of the transmitting terminal, using a distortion measuring device such as the TS-917/GG Test Set.

- b. Check the quality of the signal at the input to the Repeater.
- c. Check the signal at the output of the Repeater.
- d. Check the signal at the remote receiving end.
- e. Identify the point where the signal deteriorates.
- f. Repeat steps a. through e., sending and checking in the opposite direction.

6-3. Repeater Troubleshooting and Repair

a. Disconnect one end of C16 and C17 and, using a 20,000 ohm-per-volt meter, make a voltage check of the Repeater circuits, checking against the voltages listed on figure 4-1. Lack of voltage should indicate a defective part. Leave C16 and C17 disconnected.

b. Check each section of the Repeater by connecting the Repeater on a 4-wire basis, as shown in figure 2-1.

(1) Key a signal to the 4WSA input, and check for the signal at the 4WRA output. Both input and output must be in normal teletypewriter loops to do this.

(2) Key a signal to the 4WSB input, and check for the signal at the 4WRB output. Again, input and output must be teleprinter loops.

NOTE

Step (1) and (2) check should indicate whether the A, B, or both sections of the Repeater are defective.

c. Using proper loop current in the 4WSA loop, check for approximately 10 volts across capacitor C1; failure to obtain this reading indicates defect in the circuit of Q1 (involving CR1, R3, T1, CR2, C1, R4, and R18).

d. Using proper loop current in the 4WSB loop, check for approximately 10 volts across capacitor C8; failure to obtain this reading indicates defect in the circuit of Q2 involving (CR5, CR6, R19, R20, T4, C8, R21, or R36).

e. Although the following checks apply to the A Repeater section, in particular, they also apply to the B Repeater section.

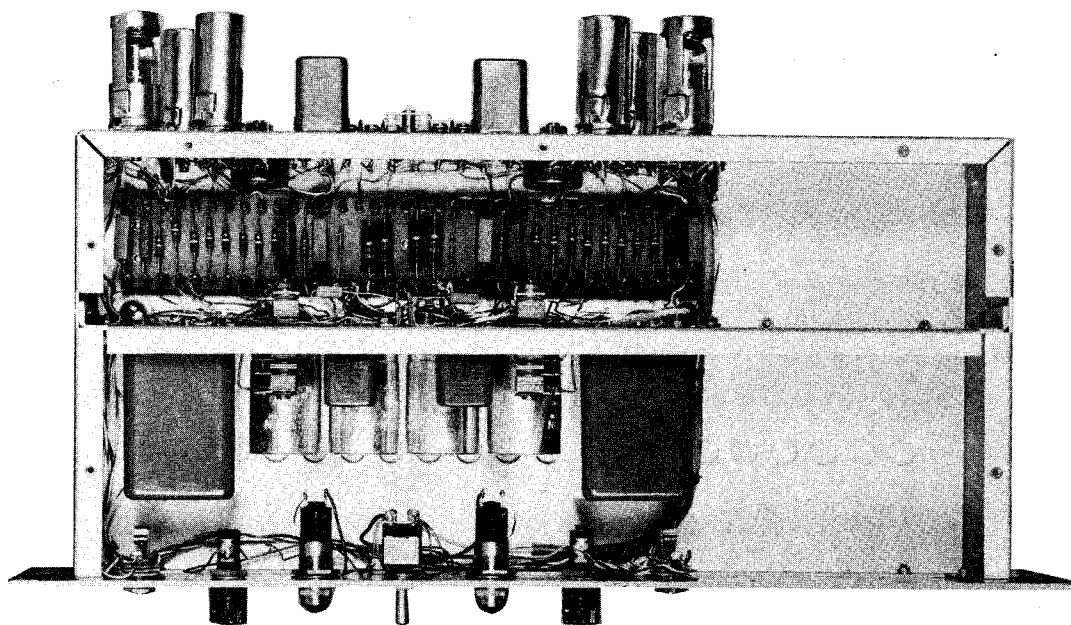

FIGURE 6-1 INSIDE VIEW

(1) With about 10 volts across the capacitor C1, check that the cathode of V2A is positive and the grids of V3 are positive (3 to 6 volts). Failure to get this indicates defective R5, R6, R8, R9, R10, C4, V1, or V2.

(2) When the 4WRA terminals are connected in a 60-ma loop, check that a voltage drop of 20 to 25 volts exists across V3 plate to cathode. Check R15, R16, V3 if voltage is incorrect.

(3) Put the input to the 4WSA terminals to space. With an oscilloscope, check that signal (about 15 kc) exists at the plate of V2B; if not, check R11, R12, R13, R14, V1, V2, C5, C6, and T2.

6-4. Replacement of Parts (Fig. 6-1).

All components are readily replaceable once the Repeater has been removed from the rack and the top plates have been removed. Tubes, input transformers, and transistors are mounted at the rear of the Repeater. Power transformers T2 and T4 are mounted on an inner chassis bracket. Most small components are mounted on the terminal board behind the tubes in the Repeater. Figure 6-2 illustrates the location of small components on this board. Each major component has its circuit symbol stamped (adjacent to the part) on the chassis. All circuit symbols are labelled on figure 4-1; some small components, not located on the terminal board, are shown on the schematic as connecting directly to a pin of a particular tube. Before removing any part involving a number of wires, make a sketch of the part, detailing wire connections and color code of each wire; use the sketch when replacing the part.

6-5. Adjustment of Controls

There are only two controls in the Repeater: (1) Bias control R4, which is adjusted to minimize bias in the A Repeater, and (2) bias control R21 which is adjusted to minimize bias in the B Repeater. To adjust these controls proceed as follows:

NOTE

Where there is little shaping on the signal to the Repeater, controls R4 and R21 will have little effect on the bias and should be turned completely clockwise.

- a. Transmit from E to W, using a zero bias signal.

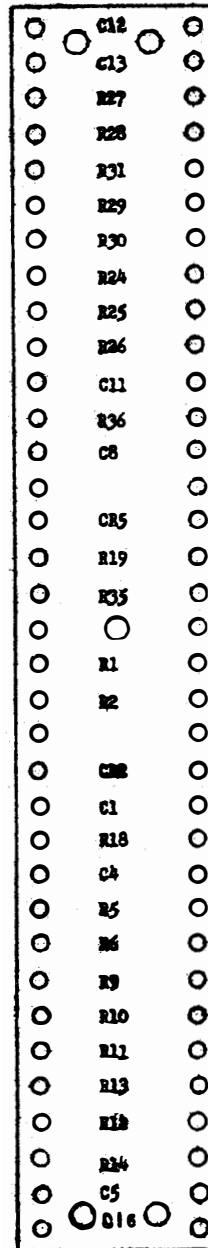

FIGURE 6-2 TELEGRAPH REPEATER, MODEL TH-42/UG

TERMINAL BOARD COMPONENTS

b. Connect a telegraph distortion analyzer (such as the TS-917/GG) in the W LOOP CUR. jack, and set up the unit to measure bias distortion.

NOTE

Make sure loop currents are correct (par. 5-1 b.), before adjustments are made.

c. Adjust bias correct variable resistor R4 to obtain minimum bias, as indicated by the TS-917/GG.

d. Transmit from W to E, using a 0 bias signal.

e. Connect TS-917/GG in the E LOOP CUR. jack and adjust R21 for a minimum bias indication.

f. In 4-wire operation, adjust R4 for the E-W traffic, and R21 for the W-E traffic.

SECTION 7

PARTS LIST

7-1. General

An equipment parts list for Telegraph Repeater TH 42/UG (serial number 234 and up) follows. The items are listed according to reference symbol number, each followed by a brief description and the STELMA part number.

PARTS LIST

<u>Ref. Symbol No.</u>	<u>Description</u>	<u>STELMA Part No.</u>
C1	Capacitor, MICA, 2000 uuf, 500v ±10%	50CM2022-3
C2	Capacitor, Elec., 50 uf, 250v	025CA5006-1
C3	Same as C2	
C4	Capacitor, MICA, 4700 uuf, 500 v, ±10%	50CM4722-3
C5	Capacitor, MICA, 100 uuf, 500 v, ±10%	50CM1012-1
C6	Same as C1	
C7	Capacitor, Paper, .05 uf, 400 v, ±20%	040CP5042
C8	Same as C1	
C9	Same as C2	
C10	Same as C2	
C11	Same as C4	
C12	Same as C1	
C13	Same as C5	
C14	Same as C7	

PARTS LIST

<u>Ref. Symbol No.</u>	<u>Description</u>	<u>STELMA Part No.</u>
C15	Not Used	
C16	Capacitor, MICA, 200 uuf, 500 v, ±10%	50CM2012-1
C17	Same as C16	
CR1	Not Used	
CR2	Diode, Germanium Crystal	11SD1016
CR3	Rectifier, Selenium 30 ma, 130 v	11SD1022
CR4	Same as CR3	
CR5	Same as CR2	
CR6	Not Used	
CR7	Same as CR3	
CR8	Same as CR3	
CR9	Same as CR3	
CR10	Same as CR3	
DS1	Lamp, .15 A, 6-8 v	16DS132
DS2	Same as DS1	
E1	Feed Thru Terminal	18MH
E2	Same as E1	
E3	Same as E1	

PARTS LIST

<u>Ref. Symbol No.</u>	<u>Description</u>	<u>STELMA Part No.</u>
E4	Same as E1	
E5	Terminal Board	B3542
F1	Fuse, 1 amp, 250 v	15FS112
F2	Same as F1	
J1	Jack, Telephone	10PJ144
J2	Same as J1	
Q1	Transistor, PNP	ST117
Q2	Same as Q1	
R1	Resistor, Fixed, Comp, 150 ohms, 2W, ±5%	200RC151
R2	Resistor, Fixed, Comp, 270 ohms, 2W, ±5%	200RC271
R3	Resistor, Fixed, Comp, 51,000 ohms, 1/2 W, ±5%	050RC513
R4	Resistor, Variable, 100,000 ohms, 1W, ±10%	100RV104-128
R5	Resistor, Fixed, Comp, 100,000 ohms, 1/2, ±5%	050RC104
R6	Resistor, Fixed, Comp, 510,000 ohms, 1/2 W, ±5%	050RC514

PARTS LIST

<u>Ref.</u> <u>Symbol No.</u>	<u>Description</u>	<u>STELMA</u> <u>Part No.</u>
R7	Resistor, Fixed, Comp, 100,000 ohms, 1W, ±5%	100RC104
R8	Same as R7	
R9	Resistor, Fixed, Comp, 1 meg., 1/2 W, ±5%	050RC105
R10	Same as R5	
R11	Resistor, Fixed, Comp, 750,000 ohms, 1/2 W, ±5%	050RC754
R12	Resistor, Fixed, Comp, 560,000 ohms, 1/2 W, ±5%	050RC564
R13	Same as R5	
R14	Same as R5	
R15	Resistor, Fixed, Comp, 2000 ohms, 1/2 W, ±5%	050RC202
R16	Same as R15	
R17	Not Used	
R18	Resistor, Fixed, Comp, 33,000 ohms, 1/2 W, ±5%	050RC333
R19	Same as R2	
R20	Same as R3	
R21	Same as R4	
R22	Same as R7	
R23	Same as R7	
R24	Same as R9	

PARTS LIST

<u>Ref. Symbol No.</u>	<u>Description</u>	<u>STELMA Part No.</u>
R25	Same as R6	
R26	Same as R5	
R27	Same as R5	
R28	Same as R12	
R29	Same as R11	
R30	Same as R5	
R31	Same as R5	
R32	Same as R15	
R33	Same as R15	
R34	Not Used	
R35	Same as R1	
R36	Same as R18	
S1	Switch, Toggle, DPST	12ST136
T1	Transformer, Audio	13B1429TR108
T2	Same as T1	
T3	Transformer, Power	13A1557TR109
T4	Same as T1	
T5	Same as T2	
T6	Same as T1	

PARTS LIST

<u>Ref. Symbol No.</u>	<u>Description</u>	<u>STELMA Part No.</u>
TB1	Not Used	
TB2	Terminal, Strip, Barrier	10PJ185
V1	Electron Tube, Miniature Twin-Triode	17VT100
V2	Same as V1	
V3	Electron Tube, Miniature Twin-Triode	17VT110
V4	Same as V1	
V5	Same as V1	
V6	Same as V3	
XF1	Fuseholder	15FS122
SF2	Same as XF1	
XDS1	Indicator, light w/Red Jewel	16DS133
XDS2	Same as XDS1	
XQ1	Socket, Transistor	18MH103
XQ2	Same as XQ1	
XV1	Socket, 9 Pin Min. Phenolic	18MH100

Paragraph
7-1

NAVSHIPS-93742

TH-42/UG
PARTS LIST

PARTS LIST

<u>Ref. Symbol No.</u>	<u>Description</u>	<u>STELMA Part No.</u>
XV2	Same as XV1	
XV3	Socket, 9 Pin Min. Ceramic	18MH126
XV4	Same as XV1	
XV5	Same as XV1	
XV6	Same as XV3	

ORIGINAL

7-6

