

"INKTRONIC[®]" PAGE PRINTER (RO)
CHECKOUT AND TROUBLESHOOTING

CONTENTS	PAGE
1. GENERAL	1
2. OPERATIONAL CHECKS	1
LOCAL CHECKS	1
ON-LINE CHECKS	2
3. TOOLS AND TEST EQUIPMENT	4
4. TROUBLESHOOTING PROCEDURE	8

1. GENERAL

1.01 This section provides operational checks and troubleshooting procedures for the INKTRONIC Page Printer (Receive-Only). It is being reissued to add a checkout procedure, incorporate current troubleshooting information, and to accommodate the latest engineering changes in the electronic circuitry and mechanical components. Since this is a general revision, marginal arrows ordinarily used to indicate additions and changes are omitted.

2. OPERATIONAL CHECKS

2.01 The following operational checks should be performed after a station is completely assembled and properly programmed. All checks should be performed upon initial installation or whenever a system trouble condition or routine maintenance requires an operational checkout. Refer to Part 4 of this section for analysis and correction of any trouble which appears during checkout.

LOCAL CHECKS

2.02 Remove the cover assembly from the base and front panel assembly at the top of the printer cabinet, and insert the TP330131 jumper in the cover interlock socket at the front left of the cover base.

2.03 Load the transport with a roll of standard teletypewriter paper.

2.04 With the power cord plugged into the ac line, open the front door of the cabinet and place the ON/OFF switch in the ON position. Close the front door. The ventilating fans should turn on. The READY lamp should light approximately 30 seconds after the door is closed.

2.05 Depress the PAPER ADVANCE pushbutton. The PAPER ADVANCE and PRINTER ON lamps should light, and the printer should feed paper.

Note: Observe proper braking action of the paper puller and paper winder motors during paper advance.

2.06 Check the related adjustments of the paper tensioner mechanism (Section 592-820-700TC).

2.07 Place the paper release lever at the top right of the transport in the OPEN position and make a pencil mark on the line feed disc (top left of transport). Hold the line feed drive belt to keep it from moving and press the PAPER ADVANCE button for a few seconds. The red paper jam lamp (top left rear of paper transport) should light after the line feed disc has rotated from 1-1/2 to 1-3/4 turns, and the line feed disc should stop rotating at the same time. Depress the lens cap of the paper jam lamp to extinguish the lamp and reset the circuit. Close the paper release lever.

2.08 If the requirement in 2.07 is not met, remove the knurled cover and adjust the potentiometer on the right side of the transport frame (clockwise decreases rotation, counterclockwise increases rotation). Press the PAPER ADVANCE button several times before rechecking this requirement.

2.09 Lift the paper roll on the paper unwinder assembly to verify that the PAPER ALARM lamp lights when the paper supply is low.

2.10 Open the front door of the cabinet and turn off the ac ON/OFF switch. Remove the paper from the transport, and remove the jumper from the interlock connector on the left side of the base. Place the cover assembly on the top of the printer, making sure it is properly seated on the base and front panel. Load the printer with paper.

SECTION 592-820-300TC

2.11 Turn on the ac ON/OFF switch and close the front door of the cabinet. The ventilating fans should turn on and the copylight in the cover assembly should light.

2.12 The READY lamp should light approximately 30 seconds after the front door is closed, provided there is no paper jam and the door and lid interlock circuit is complete. (The interlock circuit must be complete if the READY lamp lights when the PRINTER ON button is depressed during the 30-second waiting period.)

2.13 When the READY lamp is on and the paper supply is not low, the station should be ready for an on-line check.

ON-LINE CHECKS

2.14 If a sender is part of the station (for example, if the INKTRONIC printer is directly interfaced with a TELESPEED* sender and receiver), a local on-line test can be performed. For a type 2 TELESPEED installation (serial operation) the rotary switch on the switch panel of the printer must be set to the LOCAL position, and the rotary switch on the sender cabinet must be set to the SEND position. For a type 5 TELESPEED installation (parallel operation) the rotary switch on the switch panel of the printer must be set to the MONITOR OFF LINE position. A test tape on the sender can then be used to check the operation of the printer.

2.15 A test tape used to check the operation of the INKTRONIC printer should include both printing and nonprinting functions. For example, there should be a program to test the line feed function in the printer. A burst of at least 30 consecutive line feed codes is desirable for this test. The tape should include all letters of the alphabet plus symbols. Full lines of 80 characters should be included to check uniformity of character formation across the line. Also, lines of more than 80 characters without a line feed or carriage return code should be a part of the test in order to check the automatic carriage return and line feed feature after the 80th character. With this function the 81st character will be missing and the 82nd character, which will appear as the 1st character of the next line, may be distorted. If the printer has been strapped to provide options such as carriage return and line feed on line feed, these options should be checked in the test.

2.16 If the printer has a data set for dial-up or private line operation, a remote sender must be called to arrange for the test. In a dial-up system, the printer station should be placed in the talk mode, and the remote station dialed. When the remote station answers the call, a test should be requested. The two operators should agree on the

nature and duration of the test, with provisions to go back to the talk mode at a specific time. Information on baud rate and type of code - ASCII (United States of America Standard Code for Information Interchange), communications Baudot, etc - should be specified. The operator at the remote sending station must then go into the data mode, and the printer station must be placed in the data mode before the 2025 Hz recognition tone ends.

2.17 The procedure is similar for a private line installation. However, the original call must be placed over the regular phone lines to arrange for the test.

2.18 If the printer station is equipped with special modifications (discrete calling generator, etc), these functions must be tested by a sender similarly equipped.

2.19 In systems where the INKTRONIC printer is directly interfaced with type 2 or type 5 TELESPEED equipment, the various functions of the TELESPEED installation can be checked after the printer operation has been verified. Normal operation for each setting of the selector switch on the printer switch panel, for each type of TELESPEED installation, is described in Tables A through F.

2.20 If the results of the local and on-line checks are satisfactory, the station is ready for operation. If the results are unsatisfactory, refer to the appropriate steps in the troubleshooting chart.

TABLE A

TYPE 2 SEND ONLY "TELESPEED" INSTALLATION

SWITCH POSITION	FUNCTION	OPERATION
1	OFF	Printer inactive. Sender operates as conventional type 2 send only station.
2	MONITOR SEND	Printer provides page copy of data transmitted on line by sender.
3	LOCAL	Sender transmits data to printer without going on line.

*Trademark of Teletype Corporation

TABLE B

TYPE 2 RECEIVE ONLY "TELESPEED" INSTALLATION

SWITCH POSITION	FUNCTION	OPERATION
1	TAPE	Printer inactive. Receiver operates as conventional type 2 receive only station
2	PAGE	Station provides printed copy only.
3	BOTH	Receiver provides tape and printer provides page copy of received data.

TABLE C

TYPE 2 SEND/RECEIVE "TELESPEED" INSTALLATION

SWITCH POSITION	FUNCTION	OPERATION
1	REC. TAPE	Printer inactive. Sender and receiver operate as conventional type 2 send/receive station.
2	REC. TAPE REC. PAGE	Printer inactive in send mode. In receive mode, printer provides page copy and receiver provides tape.
3	REC. PAGE	Printer inactive in send mode. In receive mode, printer provides page copy but receiver does not provide tape.
4	LOCAL	With rotary switch in sender set to SEND, sender transmits data to receiver and printer without going on-line.
5	MON. SEND REC. TAPE	Printer provides page copy of transmitted data in send mode. Printer inactive in receive mode, and receiver operates as conventional type 2 receive station.

TABLE C

TYPE 2 SEND/RECEIVE "TELESPEED" INSTALLATION (Continued)

SWITCH POSITION	FUNCTION	OPERATION
6	MON. SEND REC. TAPE REC. PAGE	Printer provides page copy of data transmitted by sender and received by receiver, and receiver provides tape of received data.
7	MON. SEND REC. PAGE	Printer provides page copy of data transmitted by sender and received by receiver, but receiver does not provide tape of received data.

TABLE D

TYPE 5 SEND ONLY "TELESPEED" INSTALLATION

SWITCH POSITION	FUNCTION	OPERATION
1	MON. OFF LINE	Sender transmits data to printer without going on-line.
2	SEND TAPE	Printer inactive. Sender operates as a type 5 send only station.
3, 4	MONITOR SENDER	Printer provides page copy of data transmitted on-line by sender.

TABLE E

TYPE 5 RECEIVE ONLY "TELESPEED" INSTALLATION

SWITCH POSITION	FUNCTION	OPERATION
2	REC. TAPE	Printer inactive. Receiver operates as a type 5 receive only station.
3	REC. PAGE	Station provides printed copy only.

TABLE E

TYPE 5 RECEIVE ONLY "TELESPEED"
INSTALLATION (Continued)

SWITCH POSITION	FUNCTION	OPERATION
4	REC. BOTH	Receiver provides tape and printer provides printed copy of received data.

TABLE F

TYPE 5 SEND/RECEIVE "TELESPEED" INSTALLATION

SWITCH POSITION	FUNCTION	OPERATION
1	MONITOR OFF LINE	Sender transmits data to printer without going on-line.
2	REC. TAPE SEND TAPE	Printer inactive. Sender and receiver operate as conventional type 5 send/receive station.
3	REC. PAGE MON. SEND	Printer provides page copy of data transmitted by sender and received by receiver, but receiver does not provide tape of received data.
4	REC. TAPE PAGE MON. SEND	Printer provides page copy of data transmitted by sender and received by receiver, and receiver provides tape of received data.
5	REC. PAGE SEND TAPE	Printer inactive in send mode. In receive mode, printer provides page copy but receiver does not provide tape.
6	REC. TAPE PAGE SEND TAPE	Printer inactive in send mode. In receive mode, printer provides page copy and receiver provides tape of received copy.

TABLE F

TYPE 5 SEND/RECEIVE "TELESPEED"
INSTALLATION (Continued)

SWITCH POSITION	FUNCTION	OPERATION
7	MON. SEND REC. TAPE	Printer provides page copy of transmitted data in send mode. Printer inactive in receive mode, and receiver operates as conventional type 5 receive station.

3. TOOLS AND TEST EQUIPMENT

3.01 Tools required to service the printer are included in the TP330048 Tool Kit supplied with the printer. This kit contains the following items:

TP331425 Gauge (0.280")
 TP331426 Gauge (0.320")
 TP331041 Gauge (0.589")
 TP108805 Lubriplate
 TP330131 Jumper Cable Assembly
 TP336152 Magnet Assembly (Used for KSR Set Only)
 TP310594 Nozzle Wiper
 TP334500 Ink Aspirator
 TP334510 Electrode Cleaner
 TP334505 Filter
 TP325896 Tool Roll
 TP145867 Grease
 TP334508 Hand Cleaner

3.02 The ink aspirator (TP334500) is used to clear clogged nozzles and electrodes in the recorder. It may be used with the high voltage on or off, but should only be used after the recorder has been fully warmed up and in the printing mode for about five minutes. To use the aspirator, proceed as follows:

- (1) Remove the cover from the recorder.

CAUTION: BE CAREFUL NOT TO COME IN CONTACT WITH THE HIGH VOLTAGE ELEMENTS OF THE PLATEN AND RECORDER.

- (2) Clean the end of the aspirator with a clean tissue or shop towel.
- (3) Squeeze the bulb, place the slot in the tube over the nozzle to be cleaned, and release the bulb (Figure 1). Do not remove the tube from the nozzle until the bulb is fully released.

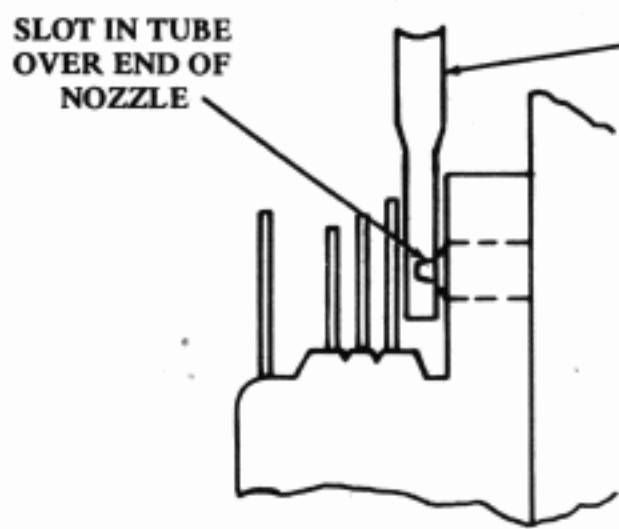

Aspirator Used to Clean Nozzle

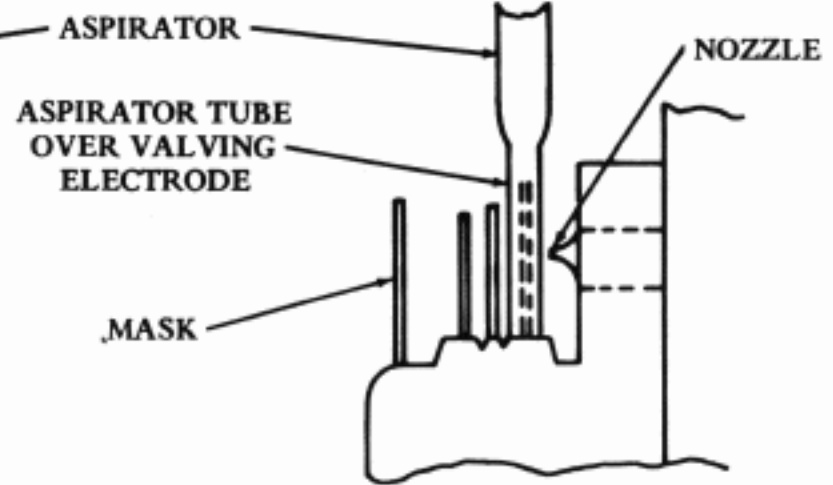

Aspirator Used to Clean Valving Electrode

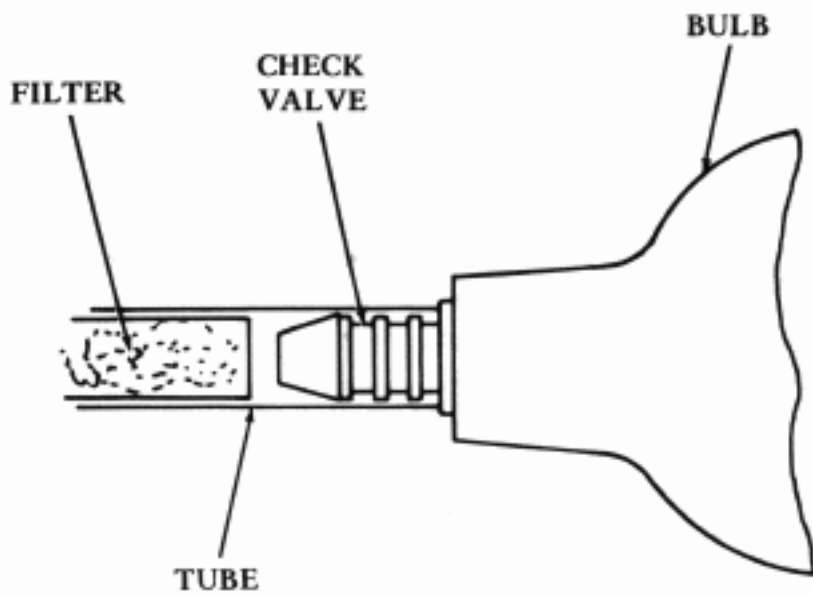

Internal View of Filter and Check Valve

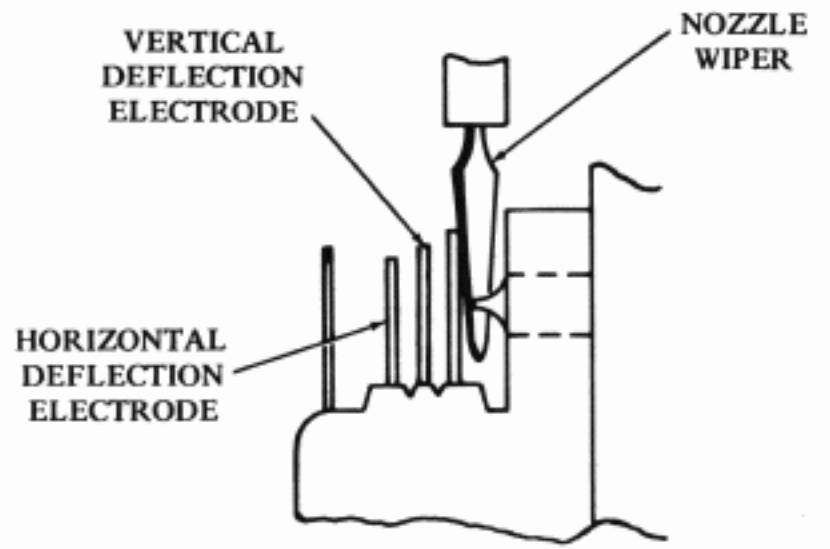

Nozzle Wiper Used to Clean Nozzle

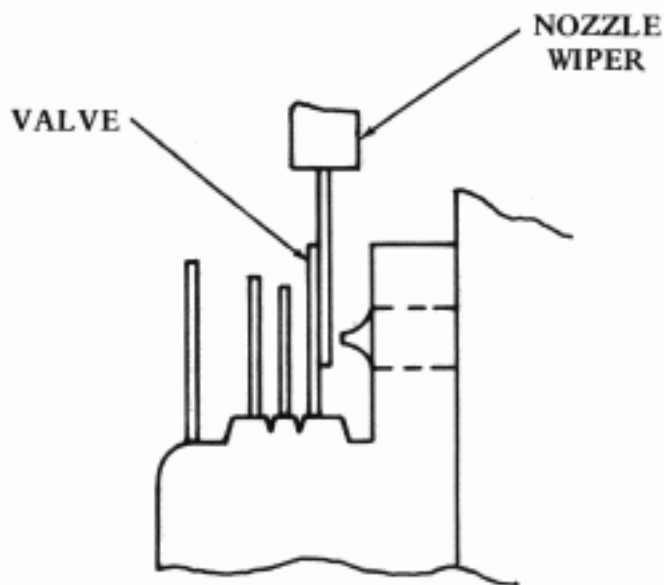

Nozzle Wiper Used to Clean Valving Electrode

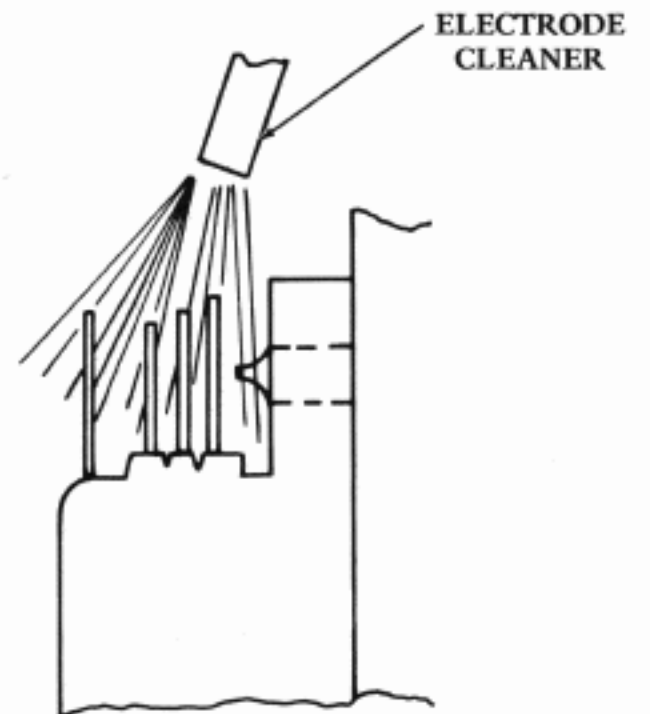

Spraying Electrodes With Electrode Cleaner

Figure 1 - Aspirator, Nozzle Wiper, and Electrode Cleaner as Used in Troubleshooting the Recorder Elements

- (4) Repeat as required to clear the nozzle.

CAUTION: USE WITH CARE TO AVOID DAMAGE TO THE NOZZLES OR ELECTRODES.

3.03 The aspirator may also be used to clear valving or deflection electrodes blocked by a film of ink. After wiping the tip with a clean tissue or shop towel, squeeze the bulb, place the tip over the electrode to be cleaned (but not the mask) and release the bulb (Figure 1).

3.04 The aspirator contains a felt filter which becomes saturated after extensive use. To replace the filter, remove the tube from the check valve. Replace the old filter with a new one (TP334505) and reposition the tube over the correct check valve (Figure 1).

3.05 The nozzle wiper (TP310594) may be used to start a clogged nozzle by fully wiping the end of the nozzle as shown in Figure 1. The wiper may also be used to clear a valving or deflection electrode blocked with a film of ink. The film is wiped from the electrode as shown in Figure 1. Always clean the wiper before using.

3.06 The electrode cleaner is a liquid spray used to clear lint and residue from the electrodes (Figure 1). This cleaner may be used with the high voltage on or off. Directions are on the can. If a nozzle fails to start after using, repeat the application or clean the nozzle further with the ink aspirator or nozzle wiper.

3.07 Test equipment required for troubleshooting the INKTRONIC printer consists of a DATS1 simulator and KS14510 volt-ohm-milliammeter or equivalent. The meter above can be used to measure low voltages throughout the printer circuit, and when used in conjunction with the DATS1 simulator, can also be used to measure the high voltages. References to the meter scales used for voltage measurements, and the reading obtained, are based on the KS14510 meter. If another meter is used, appropriate scales should be selected. The measured values will vary accordingly, but should be within reasonable limits of those indicated.

3.08 The DATS1 serves as a signal source for the INKTRONIC printer, and also works in conjunction with the meter to provide both high and low voltage measurements throughout the printer circuits. To connect the DATS1 to the printer, proceed as follows:

- (1) Remove the front door of the printer cabinet, and place the ON/OFF switch in the OFF position.
- (2) Release the thumbscrews securing the DAG and DAIF modules and slide the modules forward.
- (3) Remove the DAIF/AA1 connector from right rear of the DAIF module.
- (4) Connect the DATS/A1 connector of the simulator cable to the DAIF/AA1 cable connector (not to the module).

- (5) Connect the meter to the METER terminals of the DATS1. If a volt-ohm-milliammeter is used, set the meter for voltage measurements.

- (6) Set the DATS1 switches as follows:

REC. MSG. ---- OFF
 CHAR. AVAIL. ---- OFF
 OUTPUT ---- L. V.
 POLARITY ---- NORM.

(The settings of the CODE LEVEL switches are not critical.)

- (7) Place the cabinet interlock switch in the bypass position and set the ac ON/OFF switch to ON. The fans and copyleft should turn on and the READY lamp should light within 30 seconds.

- (8) Check the voltages at the four test jacks across the bottom of the DATS1 panel, using the red, low voltage probe of the DATS1 (polarity may be reversed for the -12 v measurement by switching the POLARITY switch to INV.). The meter must be set to an appropriate voltage range for each measurement. The +48 v reading will not be present for up to 45 seconds, when the READY lamp turns on.

CAUTION: DO NOT ATTEMPT ANY FURTHER TESTS WITH THE DATS1 IF THE PROPER VOLTAGES (+48 V, +18 V, +6 V, -12 V) ARE NOT PRESENT. REPLACE DAPS POWER SUPPLY MODULE. NEVER ATTEMPT TO USE THE DATS1 SIMULATOR PROBES UNLESS THE UNIT IS PROPERLY CONNECTED AND THE POWER IS ON.

3.09 With the switch settings described in 3.08, the DATS1 and voltmeter can be used for low voltage measurements in the printer. For high voltage measurements, all switch settings remain the same except for the OUTPUT switch, which is set to the H. V. position. This switches in the 1000:1 voltage divider in the DATS1 circuit, and all voltages at the METER terminal are 1/1000 of the voltages measured with the black, high voltage probe. Therefore, readings on the meter scale must be multiplied by 1000 to determine the actual voltage.

3.10 Low voltage pulses can be measured by placing the OUTPUT switch in the PULSE position and using the red, low voltage probe for the measurement. The meter will give an indication of either +6 v or 0 v when no pulse is present, and will switch to the opposite value when a single pulse is applied. For a series of pulses, the meter will average the changes, giving a reading of about +3 v.

3.11 To use the DATS1 as a signal source, proceed as follows:

- (1) Select a printing character by means of the CODE LEVEL switches. (See Figure 2 for ASCII and Baudot Codes.)

ASCII CODE

Bits				b7	0	0	0	0	1	1	1	1	1	1
b4	b3	b2	b1	b6	0	0	1	1	0	0	1	0	1	1
				b5	0	1	0	1	0	1	0	1	0	1
				Column	0	1	2	3	4	5	6	7		
				Row										
0	0	0	0	0	NUL	DLE	SP	0	(P				
0	0	0	1	1	SOH	DC1	!	1	A	Q				
0	0	1	0	2	STX	DC2	"	2	B	R				
0	0	1	1	3	ETX	DC3	#	3	C	S				
0	1	0	0	4	EOT	DC4	\$	4	D	T				
0	1	0	1	5	ENO	NAK	%	5	E	U				
0	1	1	0	6	ACK	SYN	&	6	F	V				
0	1	1	1	7	BEL	ETB	'	7	G	W				
1	0	0	0	8	BS	CAN	(8	H	X				
1	0	0	1	9	HT	EM)	9	I	Y				
1	0	1	0	10	LF	SUB	*	:	J	Z				
1	0	1	1	11	VT	ESC	+	:	K	[
1	1	0	0	12	FF	FS	,	<	L	\				
1	1	0	1	13	CR	GS	-	=	M]				
1	1	1	0	14	SO	RS	.	>	N	^				
1	1	1	1	15	SI	US	/	?	O	SP			DEL	

Divided Boxes: ASCII designations shown to left of diagonal line; functions performed by INKTRONIC Printer shown to right of diagonal line.

Shaded Boxes: Upon receiving these code characters the INKTRONIC Printer will be in a nonprint, nonspacing mode.

COMMUNICATIONS BAUDOT CODE

Figures	-	?	:	\$	3	!	&	#	8	'	()	.	,	9	0	1	4	5	7	:	2	/	6	"	Letters	Figures	Space	Carr. Ret.	Line Feed	Blank	
Letters	A	B	C	D	E	F	G	H	I	J	K	L	M	N	O	P	Q	R	S	T	U	V	W	X	Y	Z						
Information	1	1	1	0	1	1	1	0	0	0	1	1	0	0	0	0	1	0	1	0	1	0	1	1	1	1	1	1	0	0	0	0
Levels	2	1	0	1	0	0	0	1	0	1	1	1	1	0	0	0	1	1	1	0	0	1	1	0	0	0	1	1	0	0	1	0
	3	0	0	1	0	0	1	0	1	1	0	1	0	1	1	0	1	0	1	0	1	1	0	1	1	0	1	0	1	0	0	0
	4	0	1	1	1	0	1	1	0	0	1	1	0	1	1	0	0	1	0	0	0	1	0	1	0	0	1	1	0	1	0	0
	5	0	1	0	0	0	0	1	1	0	0	0	1	1	0	1	1	0	0	1	0	1	1	1	1	1	1	1	0	0	0	0

Figure 2 - ASCII and Communications Baudot Code Tables as Used in INKTRONIC Printer

(2) Place the REC. MSG. switch in the ON position. The PRINTER ON lamp and motors should turn on and the HIGH VOLTAGE POWER ON lamp on the DAPS power supply should light. The printer may line feed once.

(3) Place the CHAR. AVAIL. switch in the ON position. The printer should print continuous lines of the selected character.

(4) Place the CHAR. AVAIL. switch in the MAN position. Depress and release the MAN. STEP button. The printer should print the selected character once for each operation.

3.12 If the printer fails to turn on or print selected characters when operated from the DATS1, refer to the troubleshooting chart for analysis and correction of the trouble. If the printer operates satisfactorily from the DATS1, yet fails to function normally when operated on-line, the trouble is in the data set or interface area. The data set can be checked by calling a sending station or test center and requesting a remote data set test. Interface troubles are covered in the troubleshooting chart.

3.13 A complete set of wiring diagrams (WDP 0194) is supplied for each printer installation. These diagrams show actual and schematic corrections of all circuits and electrical components in the printer.

4. TROUBLESHOOTING PROCEDURE

4.01 Preliminary tests should be used to locate the source of trouble either in the logic and printer area or the data set and interface area. They can also eliminate minor troubles caused by burned out fuses or lamps, or poor electrical connections. Visually inspect cables, connectors, and components. Make sure all plug-in connectors are firmly seated, and where latching connectors are involved, that the latches are locked.

4.02 The troubleshooting chart provides step-by-step procedures to isolate troubles to a particular component or circuit card. For troubles other than data set or interface troubles, troubleshooting can be facilitated in many cases by use of the DATS1 simulator in conjunction with a meter.

4.03 The troubleshooting chart is arranged according to the sequence in which troubles would occur in a normal checkout procedure. To simplify troubleshooting, troubles should be identified in this manner. That is, if the station is not printing and the READY light is not on, the trouble would be identified as "READY light not on" rather than "No printing." The numbers of related groups of troubles on the troubleshooting chart are as follows:

Trouble Nos. 1-12	Local troubles only – no connection to sender
Trouble Nos. 13-16	On-line turn-on troubles
Trouble Nos. 17-21	No printing
Trouble Nos. 22	No line feed when on-line
Trouble Nos. 23-40	Defective printing
Trouble Nos. 41	Automatic carriage return/line feed failure

4.04 Figure 3 shows the location of fuses, connectors, switches, etc, designated in the chart, and Table G lists the circuit card locations. Figures 4 through 15 show the test points and connector pins at the front and rear of the DAG and DAD modules. Signals should be checked at these points only, as described in the troubleshooting chart.

CAUTION: USE EXTREME CARE WHEN REMOVING AND REPLACING CONNECTORS, AND IN CONNECTING METER PROBES FOR MEASUREMENTS AT VARIOUS TERMINALS, TO AVOID SHORTING TERMINALS. TURN ALL POWER OFF TO REMOVE OR REPLACE CIRCUIT CARDS.

4.05 Because of the difficulty encountered in locating failures in industrial microcircuits and replacing them on location, it is intended that defective circuit cards will be replaced by the serviceman and will be repaired at a central location.

Note: The DAPS power supply, DAR recorder, and the core plane assembly (memory) should be replaced with complete units and returned to the manufacturer or an authorized service center for repair.

4.06 When trouble analysis indicates a defective circuit card, its connectors and associated interconnecting cables should be examined for defects prior to card replacement.

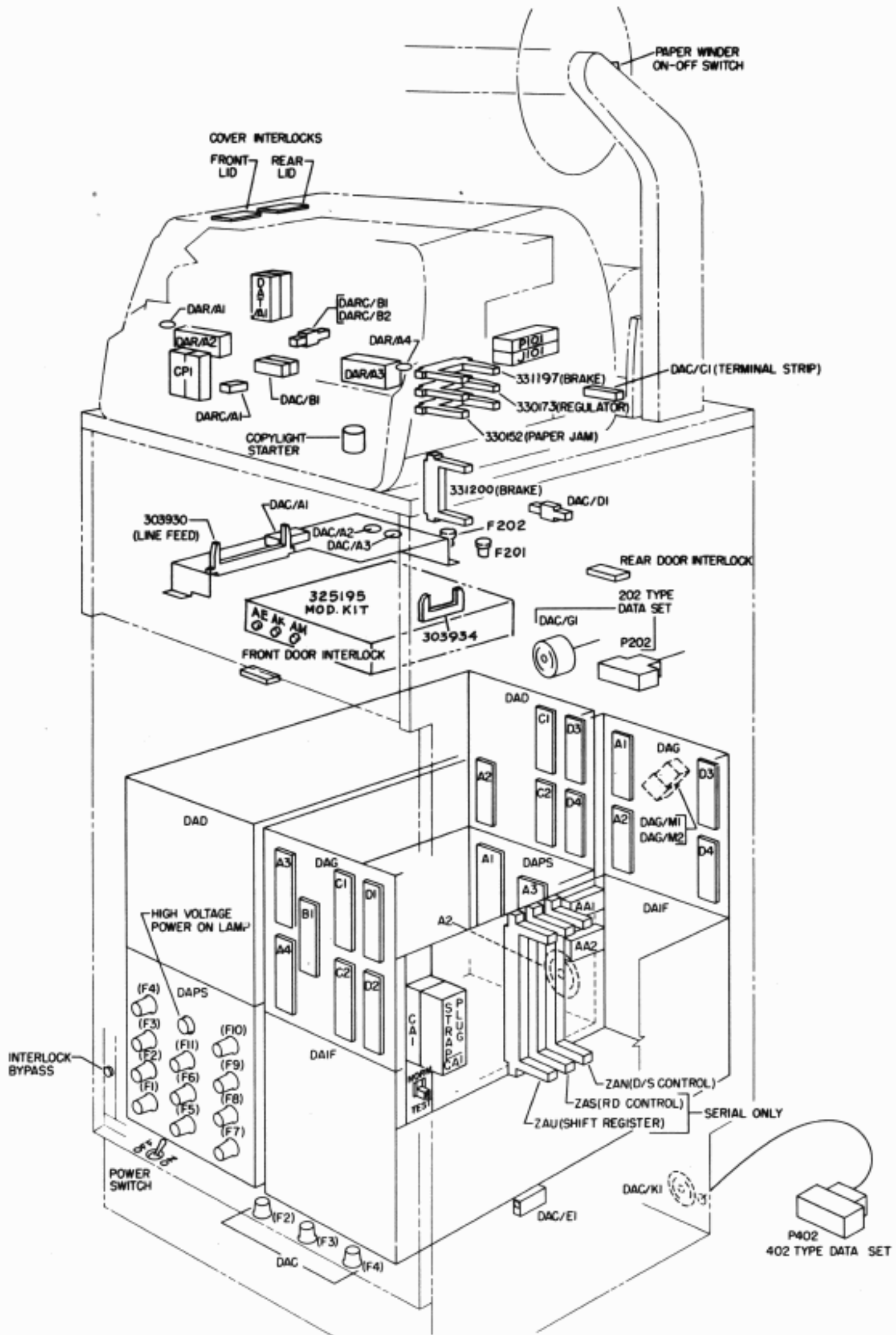

Figure 3 - Positioning of Connectors on INKTRONIC Page Printer (RO)

TABLE G
CIRCUIT CARD LOCATIONS

MODULE	CARD NUMBER	DESCRIPTION	CONNECTOR LOCATION
DAIF 1 (Serial)	322130	Shift Register Card	ZAU
	322132	Data Set Control Card	ZAN
	322180	1050 Baud R/D Card	ZAS
	322181	1200 Baud R/D Card	ZAS
	322182	890 Baud R/D Card	ZAS
	322183	840 Baud R/D Card	ZAS
	322184	600 Baud R/D Card	ZAS
DAIF 2 (Parallel)	322134	Station Control Card	ZAN
DAG	322150	Output Logic Card	DAG/D1, 2, 3, & 4
	322151	Input Logic Card	DAG/A1, 2, 3, & 4
	322152	ASCII Control Card	On 322151 card
	322153	Baudot Control Card	On 322151 card
	303929	Output Board	DAG/C1 & C2
	303927	ASCII Program Board	DAG/B1
	303928	Baudot Program Board Character Sheets	DAG/B1 Between program board & output board
DAD	322145	Spacing Drive Card	DAD/D3 & D4
	322146	Tracing Drive Card	DAD/C1, 2 & /A2
	300469	Tubes	On 322146

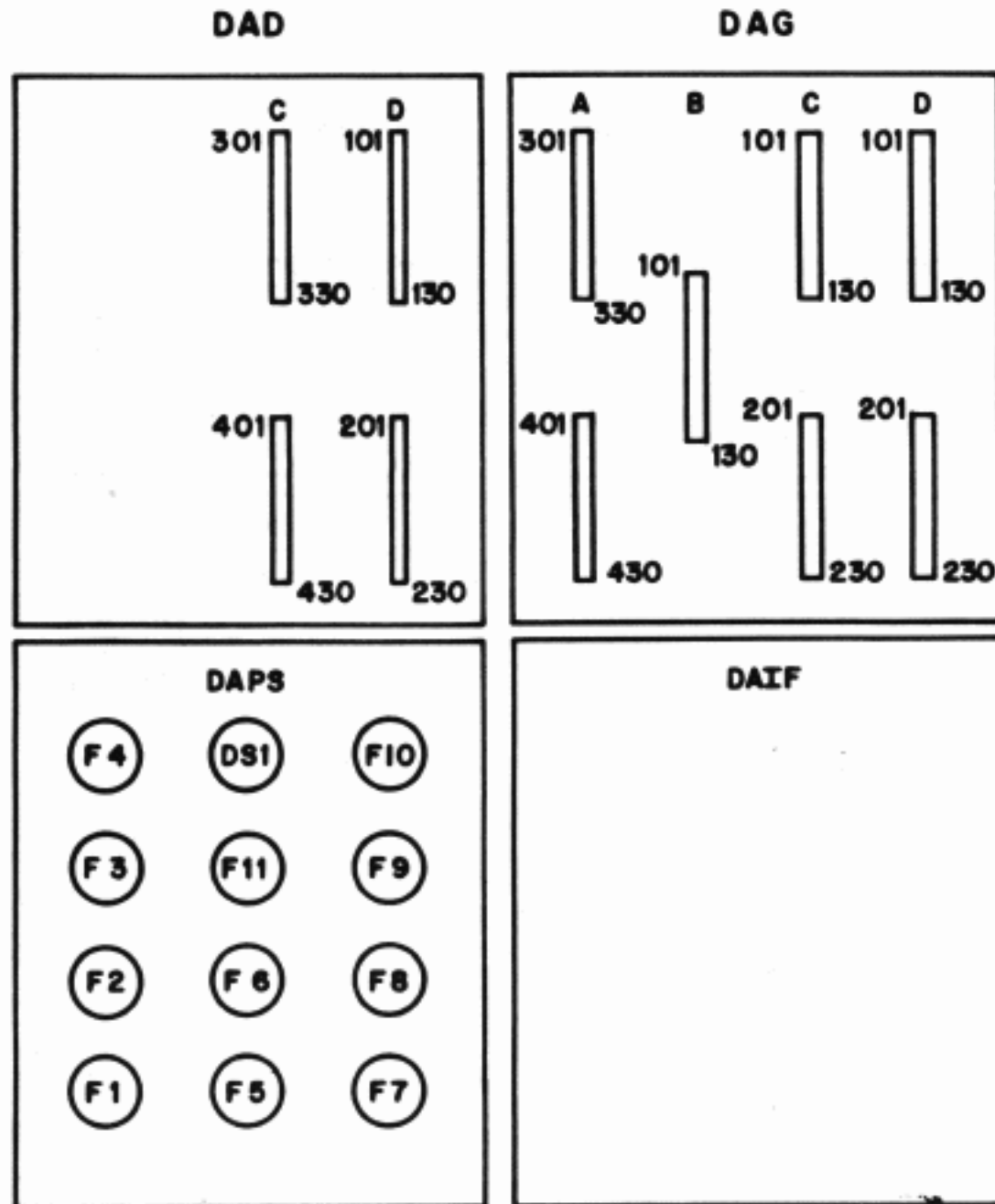

Figure 4 - Front Connectors for INKTRONIC (RO) Modules

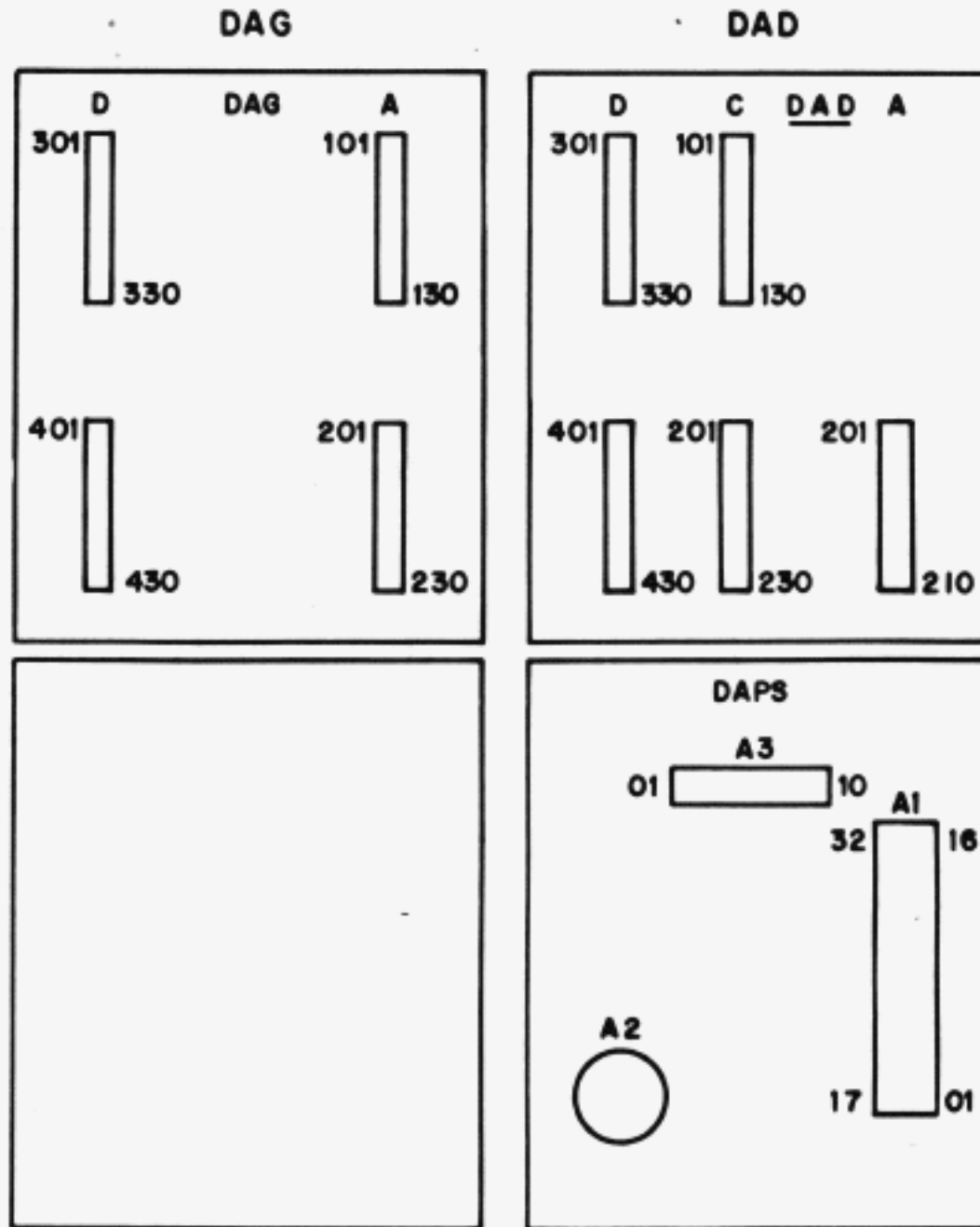

Figure 5 - Rear Connectors for INKTRONIC (RO) Modules

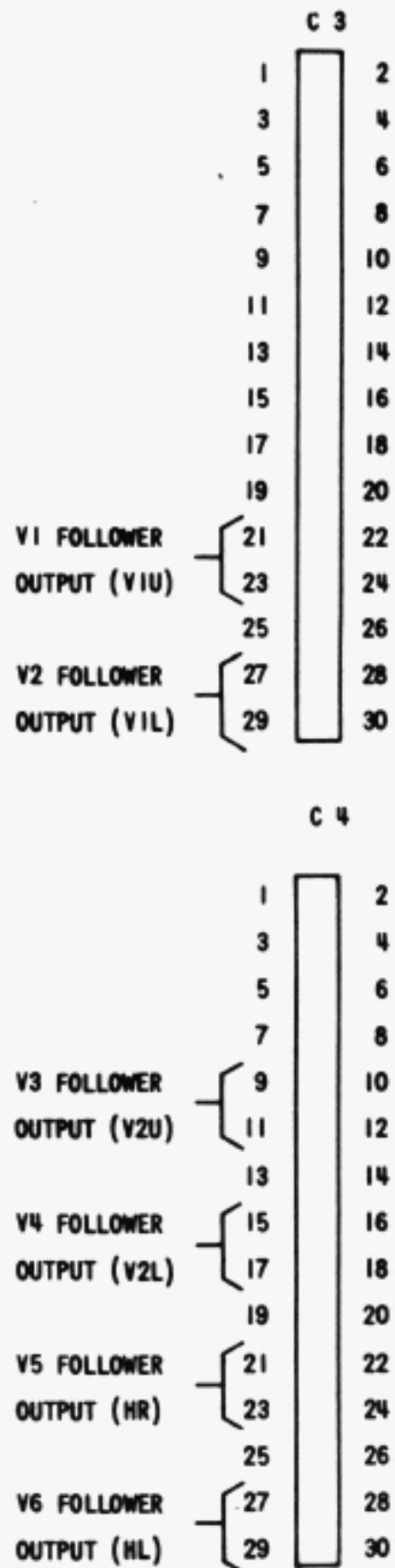

Figure 6 - Printer Drive Test Points – Front of DAD Module

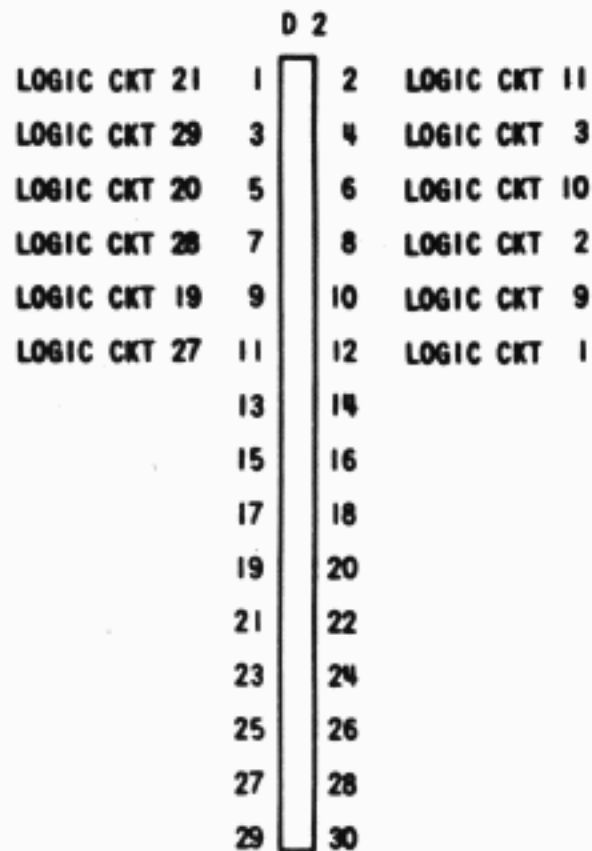
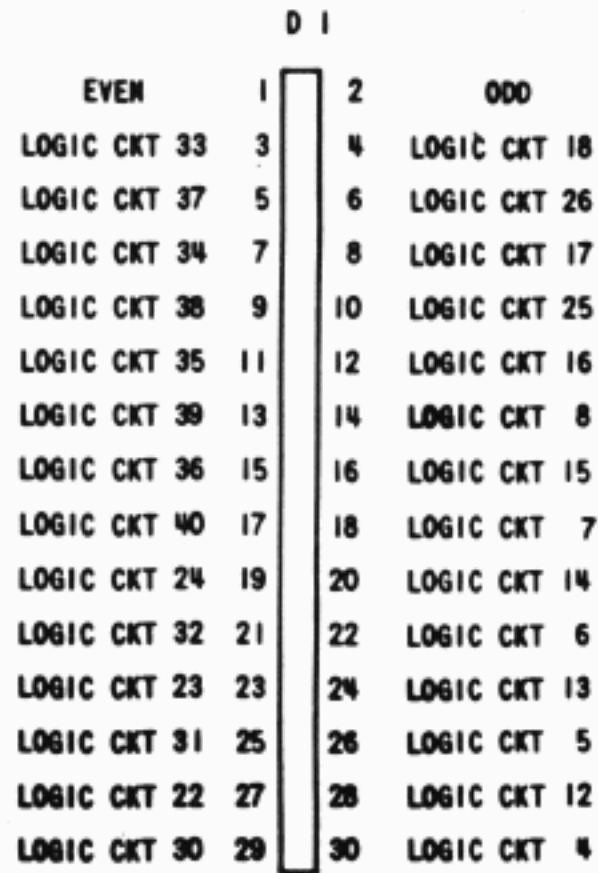

Figure 7 - Spacing Drive Test Points – Front of DAD Module

A3

(DAG/D123)	C.R.	1	2
(DAG/D125)	L.F.	3	4
(DAG/D127)	PAPER ADV.	5	6
(DAG/D129)	MEM. CLR. \overline{MC}	7	8
(DAG/D108)	OSCILLATOR	9	10
(DAG/D121)	HORIZ. TAB	11	12
(DAG/D104)	PRINT INH.	13	14
(DAG/D115)	REED INH.	15	16
(DAG/D112)	BIT $\overline{5M}$	17	18
(DAG/D113)	BIT 5	19	20
(DAG/D103)	START OF CYCLE	21	22
(DAG/D110)	PRINT INTERVAL	23	24
		25	26
		27	28
		29	30

A4

		1	2	Y1-1	(DAG/B129)
		3	4	Y1-2	(DAG/B127)
		5	6	Y2-1	(DAG/B125)
		7	8	Y2-2	(DAG/B123)
(DAG/B121)	Y3-1	9	10	X16	(DAG/B101)
(DAG/B119)	Y3-2	11	12	X15	(DAG/B102)
(DAG/B117)	Y4-1	13	14	X13	(DAG/B106)
(DAG/B115)	Y4-2	15	16	X14	(DAG/B104)
(DAG/B118)	X7	17	18	X2	(DAG/B128)
(DAG/B120)	X6	19	20	X1	(DAG/B130)
(DAG/B112)	X9	21	22	X3	(DAG/B126)
(DAG/B114)	X10	23	24	X4	(DAG/B124)
(DAG/B110)	X11	25	26	X8	(DAG/B116)
(DAG/B108)	X12	27	28	X5	(DAG/B122)
		29	30		

Figure 8 - Input Logic Connector Pins - Front of DAG Module

B1

(DAG/A410)	X16	1	2	X15	(DAG/A412)
		3	4	X14	(DAG/A416)
		5	6	X13	(DAG/A414)
		7	8	X12	(DAG/A427)
		9	10	X11	(DAG/A425)
		11	12	X10	(DAG/A421)
		13	14	X9	(DAG/A423)
(DAG/A415)	Y4-2	15	16	X8	(DAG/A426)
(DAG/A413)	Y4-1	17	18	X7	(DAG/A417)
(DAG/A411)	Y3-2	19	20	X6	(DAG/A419)
(DAG/A409)	Y3-1	21	22	X5	(DAG/A428)
(DAG/A408)	Y2-2	23	24	X4	(DAG/A424)
(DAG/A406)	Y2-1	25	26	X3	(DAG/A422)
(DAG/A404)	Y1-2	27	28	X2	(DAG/A418)
(DAG/A402)	Y1-1	29	30	X1	(DAG/A420)

Figure 9 - Program Board Connector Pins – Front of DAG Module

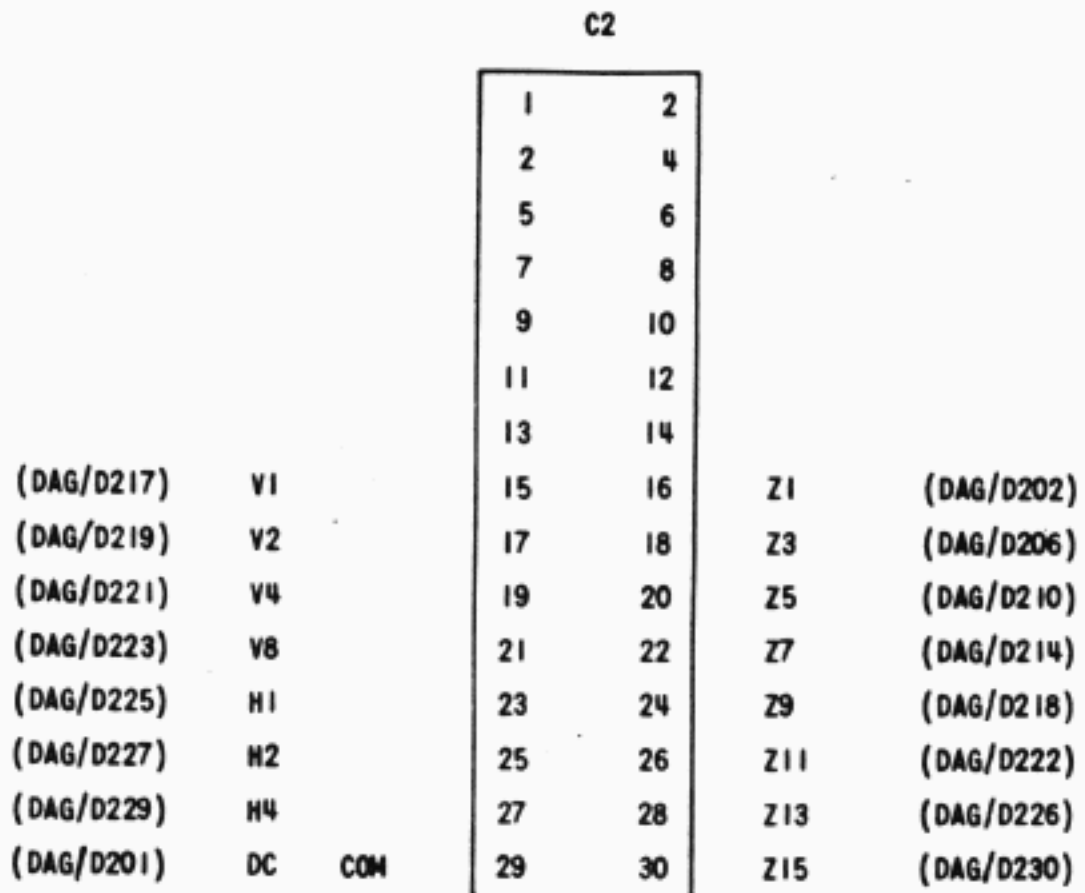
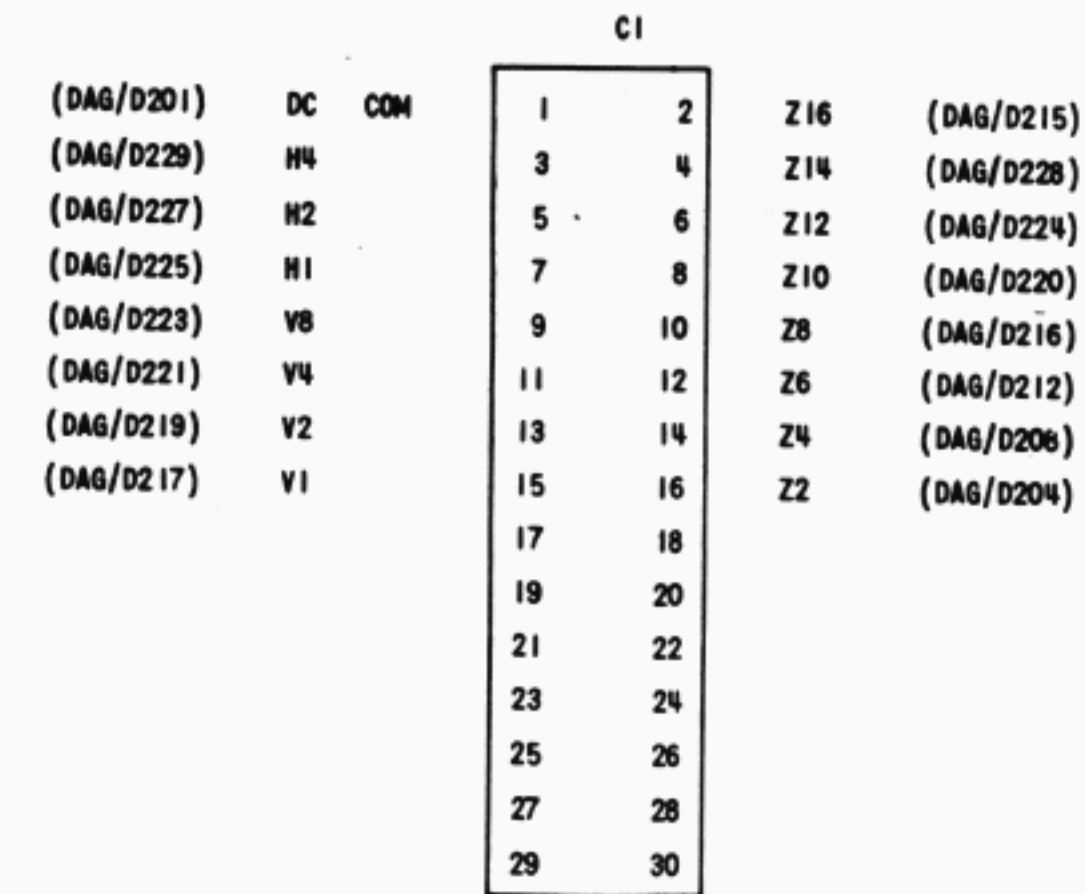

Figure 10 - Output Board Connector Pins - Front of DAG Module

		D1			
(DAG/A321) START OF CYCLE		1	2		
		3	4	PRINT INHIBIT	(DAG/A313)
		5	6		
		7	8	OSCILLATOR	(DAG/A309)
		9	10	PRINT INTERVAL	(DAG/A323)
		11	12	BIT $\overline{5M}$	(DAG/A317)
(DAG/A319) BIT 5		13	14		
(DAG/A315) REED INH		15	16		
		17	18		
		19	20		
(DAG/A311) HORIZ. TAB		21	22		
(DAG/A301) C.R.		23	24		
(DAG/A303) L.F.		25	26		
(DAG/A305) PAPER ADV.		27	28		
(DAG/A307) MEM. CLR. \overline{MC}		29	30		

		D2			
(DAG/C101-C209) DC COM		1	2	Z1	(DAG/C216)
		3	4	Z2	(DAG/C116)
		5	6	Z3	(DAG/C218)
		7	8	Z4	(DAG/C114)
		9	10	Z5	(DAG/C220)
		11	12	Z6	(DAG/C112)
		13	14	Z7	(DAG/C222)
(DAG/C102) Z16		15	16	Z8	(DAG/C110)
(DAG/C114-C215) V1		17	18	Z9	(DAG/C224)
(DAG/C113-C217) V2		19	20	Z10	(DAG/C108)
(DAG/C111-C219) V4		21	22	Z11	(DAG/C226)
(DAG/C109-C221) V8		23	24	Z12	(DAG/C106)
(DAG/C107-C223) H1		25	26	Z13	(DAG/C228)
(DAG/C105-C225) H2		27	28	Z14	(DAG/C104)
(DAG/C103-C227) H4		29	30	Z15	(DAG/C230)

Figure 11 - Output Logic Connector Pins - Front of DAG Module

D 3

1	2	
3	4	+6V DC
5	6	DC COM
7	8	
9	10	
11	12	MONOSTABLE SUPPLY (DAG/A118)
13	14	
15	16	
17	18	
19	20	
21	22	
23	24	+48V DC
25	26	
27	28	+6V DC
29	30	DC COM

D 4

(DAG/D417) HORIZ. TAB	1	2	
(CPI/18-DAD/C228) PAPER ADV.	3	4	
(DAD/D304) COLUMN SELECT "E"	5	6	COLUMN SELECT $\bar{9}$ (DAD/D307-DAG/D422)
(DAD/D315) COLUMN SELECT "D"	7	8	COLUMN SELECT 9 (DAD/D306)
(DAD/D303) COLUMN SELECT "C"	9	10	COLUMN SELECT $\bar{8}$ (DAD/D309)
(DAD/D305) COLUMN SELECT "B"	11	12	COLUMN SELECT 8 (DAD/D308)
(DAD/D313) COLUMN SELECT "A"	13	14	COLUMN SELECT $\bar{7}$ (DAD/D311)
	15	16	COLUMN SELECT 7 (DAD/D310)
(DAG/D401) HORIZ. TAB	17	18	BIT 6 (L/R) (DAD/C223)
(DAD/D301) HORIZ. TAB ODD	19	20	LINE FEED (DAC/A116-DAD/C230)
(DAD/D302) HORIZ. TAB EVEN	21	22	PAPER ADV. CLOCK $\bar{9}$ (DAG/D406)
(DAD/C222) JET DOWN	23	24	VERT 8 (DAD/C215)
(DAD/C221) VERT 1	25	26	HORIZ. 1 (DAD/C229)
(DAD/C219) VERT 2	27	28	HORIZ. 2 (DAD/C227)
(DAD/C217) VERT 4	29	30	HORIZ. 4 (DAD/C225)

Figure 12 - Output Logic Connector Pins - Rear of DAG Module

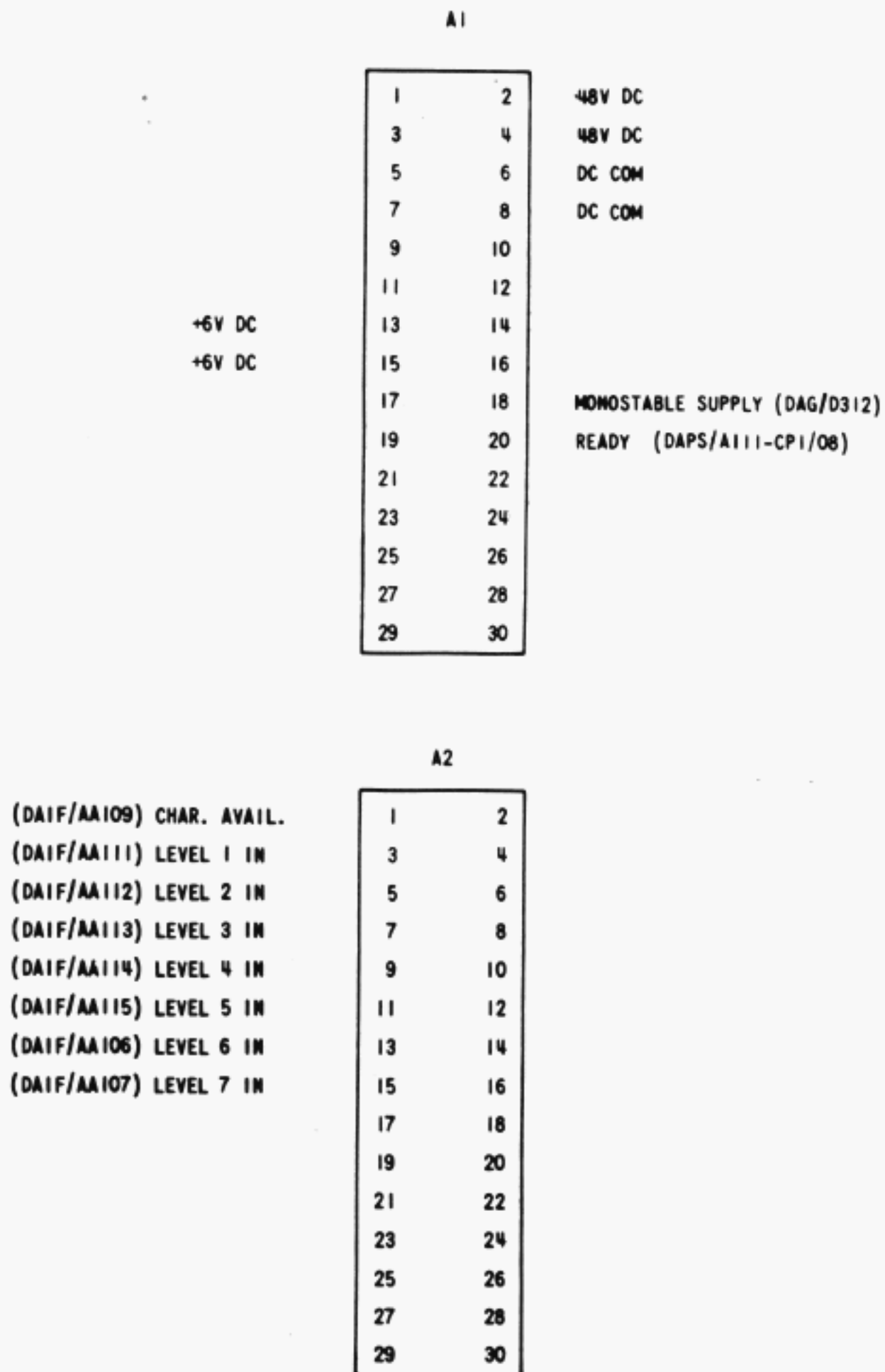

Figure 13 - Input Logic Connector Pins - Rear of DAG Module

D3

(DAG/D419)	ODD	1	2	EVEN	(DAG/D421)
(DAG/D409)	COLUMN SELECT "C"	3	4	COLUMN SELECT "E"	(DAG/D405)
(DAG/D411)	COLUMN SELECT "B"	5	6	COLUMN SELECT 9	(DAG/D408)
(DAG/D406)	COLUMN SELECT $\bar{9}$	7	8	COLUMN SELECT 8	(DAG/D412)
(DAG/D410)	COLUMN SELECT $\bar{8}$	9	10	COLUMN SELECT 7	(DAG/D416)
(DAG/D414)	COLUMN SELECT $\bar{7}$	11	12	+6V DC	
(DAG/D413)	COLUMN SELECT "A"	13	14		
(DAG/D407)	COLUMN SELECT "D"	15	16	DC COM	
	DC COM	17	18	550V DC	
		19	20	VALVE 33	(DAR/A341)
		21	22	VALVE 37	(DAR/A337)
(DAR/A318)	VALVE 26	23	24	VALVE 34	(DAR/A340)
(DAR/A327)	VALVE 17	25	26	VALVE 38	(DAR/A336)
(DAR/A319)	VALVE 25	27	28	VALVE 35	(DAR/A339)
(DAR/A328)	VALVE 16	29	30	VALVE 39	(DAR/A335)

D4

(DAR/A306)	VALVE 8	1	2	VALVE 36	(DAR/A338)
(DAR/A329)	VALVE 15	3	4	VALVE 40	(DAR/A334)
(DAR/A307)	VALVE 7	5	6	VALVE 24	(DAR/A320)
(DAR/A330)	VALVE 14	7	8	VALVE 32	(DAR/A342)
(DAR/A308)	VALVE 6	9	10	VALVE 23	(DAR/A321)
(DAR/A301)	VALVE 13	11	12	VALVE 31	(DAR/A343)
(DAR/A309)	VALVE 5	13	14	VALVE 22	(DAR/A322)
(DAR/A302)	VALVE 12	15	16	VALVE 30	(DAR/A344)
(DAR/A310)	VALVE 4	17	18	VALVE 21	(DAR/A323)
(DAR/A303)	VALVE 11	19	20	VALVE 29	(DAR/A345)
(DAR/A311)	VALVE 3	21	22	VALVE 20	(DAR/A324)
(DAR/A304)	VALVE 10	23	24	VALVE 28	(DAR/A346)
(DAR/A312)	VALVE 2	25	26	VALVE 19	(DAR/A325)
(DAR/A305)	VALVE 9	27	28	VALVE 27	(DAR/A347)
(DAR/A313)	VALVE 1	29	30	VALVE 18	(DAR/A326)

Figure 14 - Spacing Drive Connector Pins – Rear of DAD Module

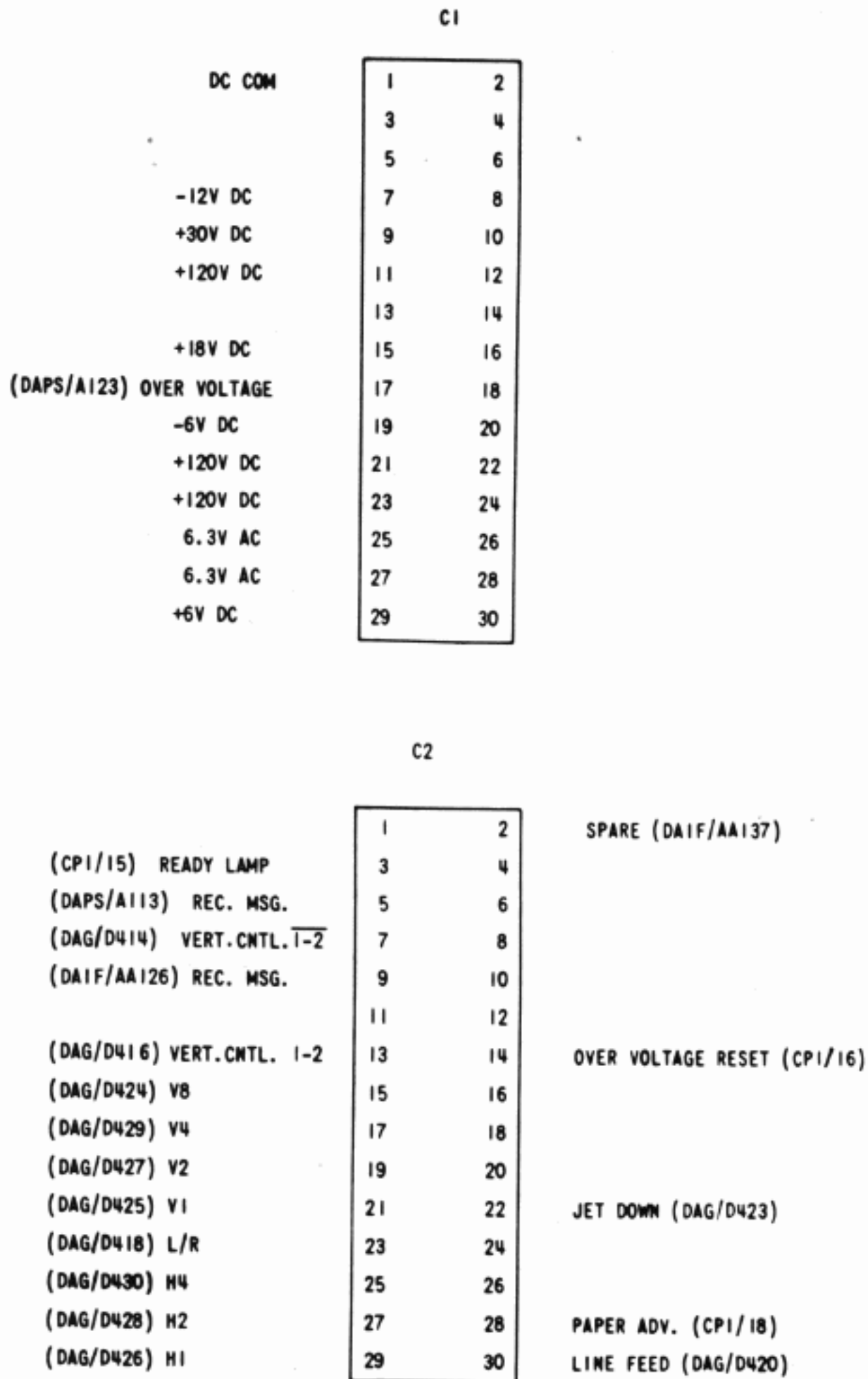

Figure 15 - Printer Drive Connector Pins - Rear of DAD Module

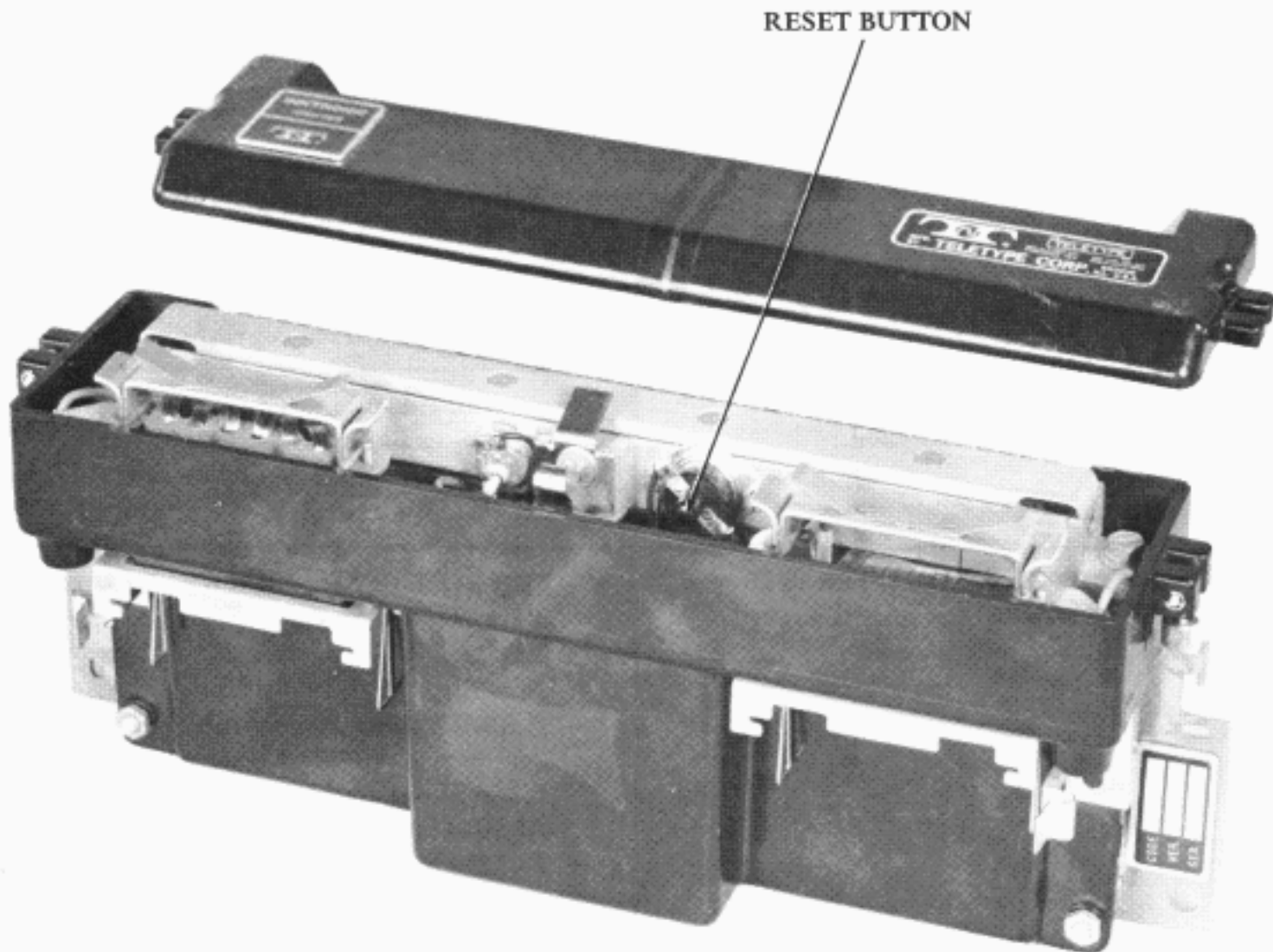

Figure 16 - Location of Ink Heater Thermostat Reset Button

"INKTRONIC" PAGE PRINTER SET (RO) TROUBLESHOOTING CHART

TROUBLE NO.	TROUBLE OBSERVED	ANALYSIS AND CORRECTION
1	Copyright and/or fans do not turn on when power is turned on (doors and cover closed).	<ul style="list-style-type: none"> a. If neither fans nor copyright turn on, check ac power to printer. Check fuse F4 in power supply and F2 at bottom front of cabinet. b. If copyright is on but fans are off, check fuse F4 at bottom front of cabinet. c. If all fuses are good, replace DAPS power supply module. d. If fans are on but copyright is off, trouble is either starter or burned out copyright.
2	PRINTER ON lamp does not light when button is depressed.	Operate cabinet bypass switch, and/or bypass cover with TP330131 assembly and recheck. If PRINTER ON lamp lights, interlock switch in front door, rear door, or cover is open. Replace if necessary.
3	READY lamp does not turn on 15 to 45 seconds after turning power on (doors and lids closed).	<ul style="list-style-type: none"> a. Depress READY button. If READY lamp lights and stays lit after releasing, a temporary overvoltage condition has been reset. b. If READY lamp does not light while button is depressed, either +48 v is not present or READY lamp is burned out. Check +48 v by depressing PAPER ALARM button. If PAPER ALARM lamp lights, but READY lamp does not, the READY lamp is burned out. If PRINTER ON lamp lights but READY lamp does not, replace fuse F8. c. If neither the PAPER ALARM lamp nor the READY lamp lights, check fuses F2 and F9 on power supply.
4	READY lamp lights when button is depressed, but does not remain lit when button is released.	<ul style="list-style-type: none"> a. Interlock may be open. See Trouble No. 2. b. Paper out or paper jam may have occurred. Check for a paper jam indication (red light on left side frame of transport). If paper is jammed or out, or if the pressure roller is in the open position, clear the condition and reset the circuit by depressing the red paper jam indicator button. If jam occurs repeatedly, see Trouble Nos. 9, 10, and 11. c. If no jam condition exists and jam indicator cannot be reset, check 1/4 amp fuse (F101) on left side frame of transport.

"INKTRONIC" PAGE PRINTER SET (RO) TROUBLESHOOTING CHART (Continued)

TROUBLE NO.	TROUBLE OBSERVED	ANALYSIS AND CORRECTION
4 (Contd)		<p>d. Check for GND at DAD/C2-03 (rear of DAD module). If present when the READY button is depressed, yet the READY light goes out when button is released, replace the TP322146 tracing drive circuit card.</p> <p>e. If a circuit card is not available immediately, connect the DATS1 to the printer as explained in 3.08. Operate the REC. MSG. switch on the DATS1 and observe whether the HIGH VOLTAGE POWER ON light on the DAPS module of the printer turns on. If it does, the printer may be returned to service and will operate without the READY light turning on until a circuit card becomes available.</p>
5	Set fails to line feed when PAPER ADVANCE button is depressed.	<p>a. Depress PAPER ADVANCE button. If the line feed motor is not operating but the line feed escapement can be heard, refer to Trouble No. 6.</p> <p>b. If the line feed motor is operating but the line feed escapement operation cannot be heard with the PAPER ADVANCE button depressed, check fuse F10 in the power supply. If F10 is good, trouble is in the TP303930 line feed driver card.</p> <p>c. If the motor is running and the line feed escapement mechanism can be heard while depressing the PAPER ADVANCE button, check adjustments in the line feed area (Section 592-820-700TC).</p>
6	Line feed motor does not run, or number of stored line feeds cannot be controlled by line feed torque potentiometer.	Defective TP330173 voltage regulator card on transport.
7	Paper winder and transport motors do not run.	Check fuse F3 in cabinet.
8	Paper winder motor does not brake immediately when slack paper is wound.	Check two 3/8 amp SL-BL fuses (F201, F202) at rear of cabinet. If good, the TP331200 dynamic brake card at the rear of the cabinet is defective.
9	Paper jam – loop does not form when paper is installed and pulled tight or when power is turned on.	Check loop forming switch or brake card TP331197.
10	Paper jam – loop of insufficient size (should be approximately 20 line feeds) develops.	Check loop sensing switch on transport.

"INKTRONIC" PAGE PRINTER SET (RO) TROUBLESHOOTING CHART (Continued)

TROUBLE NO.	TROUBLE OBSERVED	ANALYSIS AND CORRECTION
11	Paper jam – excessive paper being developed in paper loop.	Check <u>PAPER THROAT</u> adjustment in Section 592-820-700TC. Check fuse on TP331197 dynamic brake card and 3/10 amp SL-BL (F102) on back of transport. If fuses are good, the card is defective.
12	Paper jam alarm is activated at wrong time or does not operate on jam or paper out condition.	Defective TP330152 paper jam card on transport.
13	DATA lamp does not come on when DATA button is depressed with carrier being received, or call is dropped immediately if data set is equipped for auto answer. (READY lamp on and printer equipped with 202C data set.)	<ul style="list-style-type: none"> a. If PAPER ALARM lamp is on, the low paper condition must be corrected before a call can be completed. b. If PAPER ALARM lamp is on, but a low paper condition does not exist, check <u>LOW PAPER SENSING ARM</u> adjustment (Section 592-820-701TC). c. If PAPER ALARM lamp is not on, check pin 33 of TP322132 data set control card for data terminal ready signal. If approximately +6 v is present, trouble is in data set. If +6 v is not present, the data set control card is defective.
14	Station will not answer call in auto answer mode (option ZE on 202C and option E on 804A).	Trouble is in data set if station can be manually connected in data mode.
15	PRINTER ON lamp does not light after READY lamp is on and data set is in data mode.	<ul style="list-style-type: none"> a. Depress PRINTER ON button. If lamp does not turn on while depressed, bulb is burned out. b. Set NORM./TEST switch on interface module to TEST position. If PRINTER ON lamp does not light, the TP322146 tracing drive card is defective if GND does not appear at receive message lead DAD/C2-5. If GND appears at DAD/C2-5, the trouble is in the power supply (KB2 relay circuit). If PRINTER ON lamp lights, return NORM./TEST switch to NORM. position. c. NORM./TEST switch in NORM. position. Repeat call and go into data mode. If pin 27 (sets with dial-up operation) or 25 (sets with private line operation) reads from +5.5 to +18.5 v, the TP322132 data set control card is defective. If not present, the data set is defective.
16	READY lamp goes out when DATA button on data set is depressed with carrier being received or when call is answered automatically.	<ul style="list-style-type: none"> a. Check fuse F10 in power supply.

"INKTRONIC" PAGE PRINTER SET (RO) TROUBLESHOOTING CHART (Continued)

TROUBLE NO.	TROUBLE OBSERVED	ANALYSIS AND CORRECTION
16 (Contd)		<p>b. Set NORM./TEST switch of interface module to TEST position. Depress READY lamp. If arcing in the DAR is observed, release the READY lamp immediately. Trouble is in the TP322146 tracing drive card or one of its tubes is defective. If no arcing occurs, replace DAPS power supply module.</p> <p>CAUTION: TURN OFF POWER WHEN REPLACING TUBES.</p>
17	No printing – PRINTER ON light on.	<p>a. If set has a DAIF1 interface, check pin B29 of the TP322130 shift register card for receive data pulses. If receive data is not present, see Trouble No. 18 or 19. If receive data is present, check the following for source of trouble. If set has a DAIF2 interface, check pin 2 of the TP322134 station control card for receive data pulses. If receive data is not present, see Trouble No. 20.</p> <p>b. Check for inverted receive data pulses at pin B31 of TP322130 shift register card. No pulses – defective TP322130 card.</p> <p>c. If stop pulses do not appear at pin B28 of TP322130 or inverted start pulses do not appear at pin B11 of TP322130 with clock pulses at pin B30, the shift register TP322130 is defective. If clock pulses are not present, the TP322180-87 R/D (Receiving Distributor) control card is defective.</p> <p>d. If the stop, inverted start and clock pulses are all present but the character available pulses do not appear at pin B26 of TP322180-87 R/D control card, the R/D control card is defective.</p> <p>e. If all cards are good, see Trouble No. 21.</p>
18	No receive data – serial interface (printer equipped with 202C data set).	<p>a. Check pin 26 of TP322132 data set control card. If +5.5 to +18.5 v is present, a false ring indication is coming from the data set. Data set is defective.</p> <p>b. Check pin 24 of TP322132 data set control card. If inverted receive data pulses are present, the TP322132 card is defective. If inverted receive data pulses are not present, the data set is defective or no data is being received.</p>

"INKTRONIC" PAGE PRINTER SET (RO) TROUBLESHOOTING CHART (Continued)

TROUBLE NO.	TROUBLE OBSERVED	ANALYSIS AND CORRECTION
19	No receive data – serial interface (printer equipped with 202D data set).	If inverted receive data pulses are not present at pin 24 of TP322132, the data set is defective or no data is being received. If inverted receive data pulses are present, the TP322132 data set control card is defective.
20	No receive data – parallel interface.	All logic contained on one circuit card (TP332134) in DAIF2 module. Replace card and recheck.
21	No printing – DAIF operation correct and PRINTER ON light on.	<p>a. Check ink level and flow of ink from pump. If ink is not flowing, see Trouble No. 23. If pump leads (bottom of pump) are exposed, add ink. DO NOT OVERFILL – SCREWS ON TOP OF PUMP SHOULD NEVER BE COVERED.</p> <p>b. Connect DATS1 to DAIF/AA1 connector and generate repeat character A (ASCII) or E (Baudot) after sending a LETTERS shift. If the set prints, refer to Trouble No. 17. If the set does not print, proceed as follows:</p> <ol style="list-style-type: none"> 1. Check for loss of high voltage. +10,000 v on platen (DATS1 will read approx 6000 v). +5000 v on mask (DATS1 will read approx 4000 v). -1900 v on manifold (DATS1 will read approx -1800 v). If one or more of these voltages are missing, but not all, replace DAPS power supply. 2. If all of these voltages are missing, check 167 volts ac from DAPS power supply at DAT/A1-6 and 7. If 167 volts ac is not present, check fuse F5 in power supply. If 167 volts ac is present and either the platen or mask voltages are missing or low, the high voltage supply is defective. 3. If only the manifold voltage (-1900 v) is missing, check the regulator assembly by turning off the high voltage and removing the high voltage cap and regulator assembly. 4. If -2500 v (approx -2000 v with DATS1) is present at the high voltage output with the high voltage on, the regulator assembly is defective. If not present, the entire high voltage supply is defective. 5. Check for +550 v at DAD/D3-18. If not present, replace DAPS power supply.

"INKTRONIC" PAGE PRINTER SET (RO) TROUBLESHOOTING CHART (Continued)

TROUBLE NO.	TROUBLE OBSERVED	ANALYSIS AND CORRECTION
21 (Contd)		<p>c. If high voltage section is normal, proceed as follows:</p> <ol style="list-style-type: none"> 1. Check for SOC pulses at DAG/A3-21. No pulses – defective TP322151 input logic card. 2. Check for oscillator pulses at DAG/A3-9. No pulses – defective TP322150 output logic card. 3. Check for print interval pulses at DAG/A3-23. No pulses – defective TP322150 output logic card. 4. Check for print inhibit pulses at DAT/A3-13. This pin should be approx +6 v. If 0 v or pulses occur – defective TP322152 control card. 5. Check for reed inhibit pulses at DAG/A3-15. No pulses – defective TP322151 input logic card. 6. Check for odd Y driver pulses at DAG/A3-19. No pulses – defective TP322150 output logic card. 7. Check for X driver pulses at DAG/A4-9. No pulses – defective TP322151 input logic card. 8. Check for memory clear pulses at DAG/A3-7. No pulses – defective TP322151 input logic card. 9. Check for vertical output (V2) pulses at DAG/D4-27. No pulses – defective TP322150 output logic card. 10. Check jet down voltage at DAG/D4-23. If 0 v – defective TP322150 output logic card. 11. Check for +120 v at DAD/C1-11, 21, and 23. If any or all are missing, replace DAPS power supply. <p>If all of the above No Printing checks have been made, TP322146 tracing drive card is the probable cause of trouble.</p>

"INKTRONIC" PAGE PRINTER SET (RO) TROUBLESHOOTING CHART (Continued)

TROUBLE NO.	TROUBLE OBSERVED	ANALYSIS AND CORRECTION
22	No line feed while receiving traffic but set will line feed from PAPER ADVANCE button.	Defective ASCII or Baudot control board in character generator. Set up a line feed character with the CODE LEVEL switches of the DATS1. Set the OUTPUT switch to PULSE. Using the low voltage probe, observe pin 125 at the front of the DAG output logic assembly board and set the CHAR. AVAIL. switch to ON. With the CHAR. AVAIL. switch ON, the meter reading should be approximately 3 v on the 12-volt scale. With the CHAR. AVAIL. switch OFF, the meter will switch to either 0 or +6 v.
23	Light printed copy.	<ul style="list-style-type: none"> a. Check for proper ink level and fill if necessary (see Trouble No. 21). b. If both ink heater (tank not warm to touch within 15 minutes after main power is turned on) and ink pump are not operating (ink not flowing), check fuse F3 on power supply. If F3 is good, turn power off, remove tank cover, and depress ink heater thermostat reset button (Figure 16). If tank does not heat up or stay warm, and pump still does not operate, replace DAR. c. If either heater or pump is operating, but not both, replace DAR.
24	Printing trouble confined to a particular nozzle – adjacent odd and even characters, (i.e. 1 and 2, 7 and 8, etc).	<ul style="list-style-type: none"> a. If both characters are missing, the jet may be clogged or the valving electrode may not be turning on (550 v not present). Clean according to instructions in Part 3. If cleaning does not clear the trouble, cause is probably defective TP322145 spacing drive card. b. If characters are partly formed or distorted, trouble may be dirty electrodes or defective recorder. If cleaning does not clear trouble, replace recorder.
25	A number of characters partially or totally missing in any location on the page.	If it can be determined that this group is controlled by the same X or Y driver, the TP322151 input logic card is defective (determine by examining 8252WD).
26	Every other character missing.	Trouble is in TP322146 tracing drive card. Replace and recheck.
27	A character is malformed or missing regardless of location on page.	Trouble is likely to be on individual character sheet in the DAG module or open diode on program board. Replace appropriate core plane assembly (entire memory assembly – program board, output board, and character sheets): TP325740 ASCII TP325760 Baudot Communications TP325770 Baudot Weather

"INKTRONIC" PAGE PRINTER SET (RO) TROUBLESHOOTING CHART (Continued)

TROUBLE NO.	TROUBLE OBSERVED	ANALYSIS AND CORRECTION
28	Character groups missing in uniformly spaced locations across a line of copy (except as indicated in Trouble No. 30).	Trouble is probably in TP322150 output logic card.
29	Defective printing – missing pair or pairs of characters.	Defective reed switch or driver circuit. With power off, ground pin A3-11 of the DAG front panel, taking care that no other pins are grounded. Turn the ac power on. When the READY lamp comes on, set the REC. MSG. switch on the DATS1 to ON, the CHAR. AVAIL. switch to MAN, and the OUTPUT switch to H.V. Depress the PAPER ADVANCE button and release. Using the MAN. STEP switch, step the printer to the suspected column, and with the high voltage probe, check for +550 v at the rear of the spacing drive circuit card TP322145. If +550 v is not observed, replace the circuit card. Take care that the +550 v is present at the suspected column and not during the printing of the two previous characters. If +550 v does appear, yet the characters are not printing, the problem could be a clogged jet or blocked electrodes which should be cleaned as described in Part 3.
30	Defective printing – every other pair of characters missing.	<ul style="list-style-type: none"> a. If +550 v is not appearing at the valve (DAR/A3) where the characters are missing, at the time they should be printing, the trouble is in the TP322150 output logic card. b. If +550 v is appearing at the valves in question, the trouble is on the TP322146 tracing drive card. c. Try to correct the trouble by replacing high voltage tubes V3 or V4, if the trouble is confined to odd numbered nozzles. If the trouble is confined to even numbered nozzles, the cause could be V1 or V2. If tube replacement does not correct the trouble, the TP322146 tracing drive card is defective.
31	Distorted printing – improper vertical alignment with underscoring.	Check fuse F7
32	Distorted printing – narrow characters.	Defective horizontal amplifier tube or circuit. Remove the DAR/A2 connector from the recorder. Set the OUTPUT switch on the DATS1 to the H.V. position, the CHAR. AVAIL. switch to MAN, and the REC. MSG. switch to ON. Set the meter to the 12-volt dc range.

"INKTRONIC" PAGE PRINTER SET (RO) TROUBLESHOOTING CHART (Continued)

TROUBLE NO.	TROUBLE OBSERVED	ANALYSIS AND CORRECTION
32 (Contd)		<p>a. To check the right horizontal amplifier (V5), insert the high voltage probe into pin 8 of the DAR/A2 connector. Depress and release the PAPER ADVANCE key on the printer. The meter should read about 1350 v. Depress and release the MAN. STEP button of the DATS1 once. The meter reading should be about 2200 v. Set the REC. MSG. switch to OFF.</p> <p>b. To check the left horizontal amplifier (V6), insert the high voltage probe into pin 10 of the DAR/A2 connector, and turn the REC. MSG. switch ON. Depress and release the PAPER ADVANCE key on the printer. The voltmeter should read about 2850 v. Depress and release the MAN. STEP button of the DATS1 once. The meter should read about 2000 v. Set the REC. MSG. switch to OFF, remove the high voltage probe from the DAR/A2 connector, and reconnect the connector to the recorder.</p> <p>c. If the proper voltages are not observed in these tests, replace the appropriate horizontal amplifier tube and recheck the operation. If the proper voltages are still not present, yet the tubes are known to be good, replace the TP322146 printer drive circuit card and recheck the operation.</p>
33	Distorted printing – every other pair of characters distorted or out of line vertically.	<p>a. If character pairs associated with odd numbered valves are distorted, the cause could be high voltage tube V3 or V4. If character pairs associated with even numbered valves are distorted, V1 or V2 could be the cause.</p> <p>b. If the tubes are found to be good, the cause is the TP322146 tracing drive card.</p>
34	All characters malformed.	TP322150 output logic card defective.
35	Every other character missing.	Trouble is in TP322146 tracing drive card.
36	All characters dark and distorted.	Trouble may be caused for a short period by overheating of the manifold which should result in operation of the thermal cutout, followed by light printing. See Trouble No. 23.
37	Overprinting.	<p>a. If overprinting occurs in one character pair location (associated with one jet), the trouble is probably in the TP322145 spacing drive card.</p>

"INKTRONIC" PAGE PRINTER SET (RO) TROUBLESHOOTING CHART (Continued)

TROUBLE NO.	TROUBLE OBSERVED	ANALYSIS AND CORRECTION
37 (Contd)		<p>b. If overprinting occurs in all locations across the page, and line feed is operating normally, the TP330308 high voltage regulator located in the cover assembly of the high voltage power supply may be at fault.</p> <p>c. If overprinting occurs in every second column, the TP322146 tracing drive card is probably the cause.</p>
38	Errors in copy – wrong character printing.	If it can be determined that one level is always marking or spacing (see code charts of Figure 2), TP322151 input logic card is defective.
39	Missing dots on a number of characters.	TP322150 output logic card is probably the cause.
40	Improper spacing – characters appear in pairs or overlay occurs.	See <u>PLATEN-MANIFOLD CLEARANCE</u> adjustment in Section 592-820-700TC.
41	Set does not automatically line feed and/or carriage return after receipt of 81st character.	Trouble is in TP322150 output logic card.