

23 November 1966

Cog Service: USN FSN:

TRANSMITTER GROUP AN/WRA-3

Functional Class:

USA

USN

USAF

TYPE CLASS:

Used by

MANUFACTURER'S NAME/CODE NUMBER: Hoffman Electronics Corporation, Military Products Division, (82260).

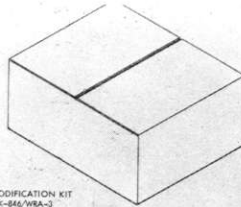

MODIFICATION KIT
MK-846/WRA-3
(INCLUDES TRANSMITTER
TRANSFER CONTROL
C-6562/WRA-3)

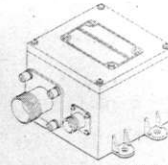

RELAY ASSEMBLY
RE-754/WRT-4
UNIT 7

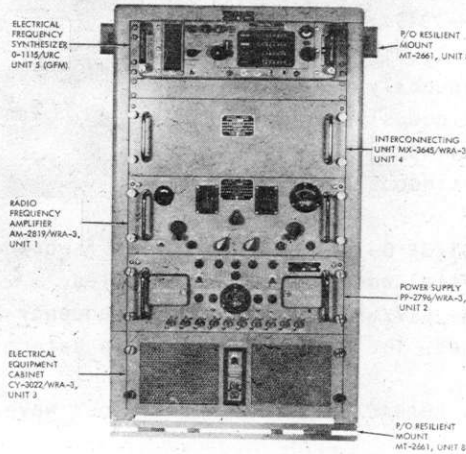

TRANSMITTER GROUP AN/WRA-3

FUNCTIONAL DESCRIPTION:

Transmitter Group AN/WRA-3 is a continuous wave (CW) transmitter primarily intended for use as an exciter for Radio Set AN/URC-32 and Radio Transmitting Set AN/WRT-2. However, it may also be used independently for direct transmission. The equipment is designed for installation aboard surface and undersurface vessels.

No field changes in effect at time of preparation (25 July 1966).

RELATION TO OTHER EQUIPMENT:

The AN/WRA-3 is similar to Transmitter Group AN/WRA-3(XN-1). The basic differences between the two equipments is that the AN/WRA-3 has been upgraded in the use of non-standard parts, an RF drive control gear box has been added, and RF dial-lights have been incorporated, also Relay Assembly RE-754/WRT-4 is now supplied and the accompanying modification kit has been changed. Transmitter Transfer Control C-6562/WRA-3 (part of the modification kit) has been redesigned, and Synthesizer 0-1115/URC is now used in place of the 0-792/SRC.

EQUIPMENT REQUIRED BUT NOT SUPPLIED:

(1) Electronic Multimeter AN/USM-116; (1) Multimeter AN/PSM-4; (1) Oscilloscope AN/USM-117; (1) RF Signal Generator CAQI-606-A; (1) Dummy Load DA-91/U; (1) Radio Receiver R-1051/URC; (1) Tube Socket Adapter Test Kit AN/USM-119; *Bulk Cable, RG-218/U, DSGA-4, RG-58C/U, TTHFWA-1-1/2, MSCA-7, and RG-213/U; (1) Telegraph Key (Any Type); Miscellaneous Hardware.

*As required by Specific AN/WRT-2 or AN/URC-32 installation when used with Modification Kit MK-846/WRA-3.

TECHNICAL CHARACTERISTICS:

FREQUENCY RANGE

ELECTRICAL FREQUENCY SYNTHESIZER 0-1115/URC(GFM)

- BAND 1: 2 to 4.25 mc, one channel every 12.5 cycles.
- BAND 2: 4 to 8.5 mc, one channel every 25 cycles.
- BAND 3: 8 to 17 mc, one channel every 50 cycles.
- BAND 4: 16 to 34 mc, one channel every 100 cycles.

RADIO FREQUENCY AMPLIFIER AM-2819/WRA-3

- BAND 1: 2 to 4 mc, continuously variable.
- BAND 2: 4 to 8 mc, continuously variable.
- BAND 3: 8 to 16 mc, continuously variable.
- BAND 4: 16 to 23 mc, continuously variable.
- BAND 5: 23 to 32 mc, continuously variable.

TYPE OF FREQUENCY CONTROL

ELECTRICAL FREQUENCY SYNTHESIZER 0-1115/URC(GFM): The frequency of the electrical frequency synthesizer is crystal and reactance controlled.

RADIO FREQUENCY AMPLIFIER AM-2819/WRA-3: The radio frequency amplifier is manually controlled and reactance tuned. The output frequency is determined by the electrical frequency synthesizer.

TYPE OF EMISSION AND MODULATION CHARACTERISTICS: Continuous wave, A0, or A1 emission.

POWER OUTPUT

FOR DIRECT TRANSMISSION: Adjustable up to 15 watts, into a 50 ohm load.

FOR EXCITATION: Adjustable up to 1.5 watts, into a 50 ohm load.

FREQUENCY STABILITY: The frequency of the transmitter group is stable to one part in 100 million per day.

ELECTRICAL INPUT AND OUTPUT DATA

ELECTRICAL FREQUENCY SYNTHESIZER 0-1115/URC(GFM): The output of the electrical frequency synthesizer is adjustable from 1.0 to 2.5 volts. This output is 2.0 volts when the 0-1115/URC is used with the transmitter group.

RADIO FREQUENCY AMPLIFIER AM-2819/WRA-3: Input from the electrical frequency synthesizer is 80 milliwatts into 50-ohm load. An additional input is applied to the radio frequency amplifier only when auxiliary equipment is used. This input also has a nominal input impedance of 50 ohms. The output is variable to either 1.5 watts into 50-ohms (for excitation) or 15 watts into 50 ohms (for direct-transmission).

CHARACTERISTICS OF RECOMMENDED ANTENNAS: For direct transmission, a tunable antenna with an input impedance of 50-ohms is required.

AMBIENT TEMPERATURE LIMITATIONS: The transmitter group will operate satisfactorily within the ambient temperature range of from 0 to 50 deg C (32 to 122 deg F).

696

TRANSMITTER GROUP AN/WRA-3

CHARACTERISTICS OF POWER SUPPLY PP-2796/WRA-3: The power supply operates with 115 v, 47.5 to 63.0 cps, single phase primary power input. The power consumption is a nominal 595 watts during standby operation and a nominal 1020 watts during locked-key cw operation. The power factor is from 0.85 to 1.0 depending upon mode of operation. The power supply has the following nominal outputs:

2 amp at + 28 v dc	- 24 to - 39 v dc (bias)	1.4 amp at 144(RMS)
0.7 amp at - 28 v dc	80 ma at + 300 v dc	400 cps quasi
1.4 amp at - 28 v dc	220 ma at + 950 v dc	square wave

MAJOR COMPONENTS

QTY	ITEM	DIMENSIONS (INCHES)	WEIGHT (LBS)
1	Transmitter Group AN/WRA-3 includes:		607
1	Electrical Equipment Cabinet CY-3022/WRA-3	22-1/4 x 23-1/4 x 37-1/2	265.5
1	Electrical Frequency Synthesizer (GFM)0-1115/URC	5-1/4 x 19 x 21-1/2	90.0
1	Radio Frequency Amplifier AM-2819/WRA-3	7 x 19 x 21-1/2	45.0
1	Power Supply PP-2796/WRA-3	7 x 19 x 23-1/4	103.0
1	Interconnecting Unit MX-3645/WRA-3	7 x 19 x 21-13/16	9.5
1	Resilient Mount MT-2661/WRA-3		
	Base	4 x 22-1/4 x 22-45/64	67.0
	Stabilizer	2-3/4 x 6-3/4 x 25-3/4	27.0
1	Relay Assembly RE-754/WRT-4	3-3/4 x 5-1/2 x 5-5/8	3.0
1	Modification Kit MK-846/WRA-3		
2	Technical Manual NAVSHIPS 0967-031-9010		
2	Maintenance Standards Book 0967-031-9030		
1	Performance Standard Sheet NAVSHIPS 0967-031-9020		
2	Technical Manual NAVSHIPS 94829		
	Miscellaneous Parts Box, Containing:	2 x 6 x 9	
1	Connector MS35168-88F		
1	Connector UG-21E/U		
*4	Fuse, 6 ampere F02A250V6AS(3F1, 3F2)		
*4	Fuse, 12 ampere F03A250V12AS(3F1, 3F2)		
**	Miscellaneous Hardware		

*Alternate fuses for 115 v ac or 230 v ac operation.

**For fastening the resilient mount to the Electrical equipment Cabinet.

REFERENCE DATA AND LITERATURE:

NAVSHIPS 0967-031-9010: Technical Manual for Transmitter Group AN/WRA-3.

SHIPPING DATA

PKGS	VOLUME (CU FT)	WEIGHT (LBS)
------	----------------	--------------

PROCUREMENT DATA

PROCURING SERVICE: USN
SPEC &/OR DWG:

DESIGN COG: USN, NAVSHIPS

TRANSMITTER GROUP AN/WRA-3

CONTRACTOR	LOCATION	CONTRACT OR ORDER NO.	APPROX. UNIT COST
Hoffman Electronics Corporation, Military Products Division	El Monte, California	NObsr-91345	

869

21 November 1966

Cog Service: USN

FSN:

NAVIGATIONAL SET OMEGA AN/WRN-2(XN-1)

Functional Class:

USA

USN

USAF

TYPE CLASS:

Used by

MANUFACTURER'S NAME/CODE NUMBER: ITT Federal Laboratories, (90348).

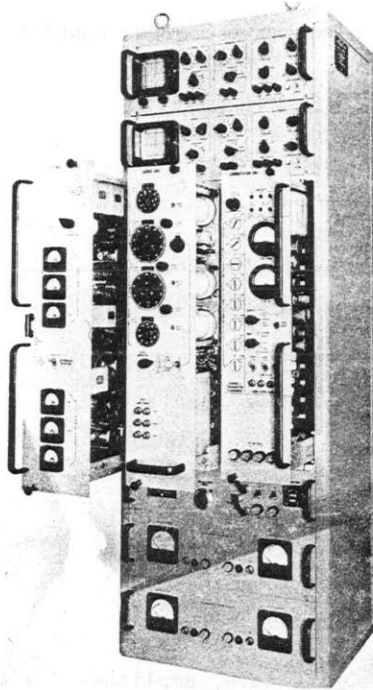

NAVIGATIONAL SET OMEGA AN/WRN-2(XN-1)

FUNCTIONAL DESCRIPTION:

Navigational Set Omega AN/WRN-2(XN-1) basically consists of a receiver and associated antenna system for receiving omega navigation signals and of timing and phase measuring equipment for determining position.

No field changes in effect at time of preparation (24 March 1966).

RELATION TO OTHER EQUIPMENT:

The AN/WRN-2(XN-1) is Type II equipment and it is similar to the Type I Omega Navigational Set AN/URN-8(XN-1) except that it is for shipboard use; it includes an automatic search feature, zero velocity, error-servo system, and it is a higher gain RF unit.

EQUIPMENT REQUIRED BUT NOT SUPPLIED: None.

1.3 AN/WRN-2(XN-1): 1

TECHNICAL CHARACTERISTICS:

FREQUENCY RANGE

RECEIVER: 8.2 to 15.2 kc continuous or 10.2 kc fixed.
 LOCAL OSCILLATOR SYNTHESIZER: Stepped 10, 11, 12, 13, 14, 15, 16, 17 kc or 12 kc fixed.
 FREQUENCY STANDARD CONTROL: Manual or automatic (phase locked to master transmitter).
 RECEIVER TYPE: Superheterodyne.
 TYPE OF RECEPTION: Pulsed cw, at pulse repetition rates of 5 or 10 cps.
 BANDWIDTH: 50 cps nom.
 ANTENNA: 35 ft. whip antenna with or without antenna coupler.
 DYNAMIC RANGE: 5 to 500,000 uv.
 MAX PHASE TRACKING RATE: 10° per min.
 ACCURACY DATA: Differential phase error within 2°.
 OPERATING CONDITIONS: Standby and operate.

RF SECTION INPUTS

RF INPUT FROM ANTENNA: 5 to 500,000 uv.
 1 KC FROM COMMUTATOR ASSY: Sq wave, amplitude 8 v.
 TIME SHARED 1.8 KC REFERENCE OR CW 1.8 KC FROM COMMUTATOR: Sine wave at 3 v peak-to-peak.

RF SECTION OUTPUTS

SIGNAL MAGNITUDE TO DIGITAL DATA CONVERTER: Variable.
 SIGNAL PLUS NOISE TO DIGITAL DATA CONVERTER: Variable.
 PHASE ERROR TO SERVO ASSY: Variable.
 COHERENT DETECTOR ENVELOPE TO COMMUTATOR: Variable.

COMMUTATOR SECTION INPUTS

TIME SHARED 1.8 KC REFERENCE FROM SERVO ASSY: 3 v sine wave.
 100 KC FROM 1 MC OSCILLATOR: 3 v sine wave.
 COHERENT DETECTOR ENVELOPE FROM RF ASSY: Variable.

COMMUTATOR SECTION OUTPUTS

1.8 KC CW REFERENCE TO SERVO ASSY: Sine wave, amplitude 7 v peak-to-peak.
 1 KC TO RF ASSEMBLY: Sq wave, amplitude 8 v.
 SHORT GATES TO SERVO ASSY: Sq wave, amplitude 8 v.
 LONG GATES TO SERVO ASSY: Sq wave, amplitude 8 v.
 LONG GATES TO LOOP ANTENNA COUPLER: Sq wave amplitude 8 v.
 1.8 KC REFERENCE TO RF ASSEMBLY: Variable.

SERVO SECTION INPUTS

1.8 KC REFERENCE FROM COMMUTATOR ASSY: Sine wave amplitude 7 v peak-to-peak.
 PHASE ERROR FROM RF SECTION: Variable.
 SHORT GATES FROM COMMUTATOR ASSY: Sq wave, amplitude 8 v.
 LONG GATES FROM COMMUTATOR ASSY: Sq wave, amplitude 8 v.

SERVO SECTION OUTPUTS

TIME SHARED REF SIGNALS TO COMMUTATOR: Sine wave at 3 v peak-to-peak.
 SHORT GATED RELAY DRIVE TO RF ASSY.
 SYNCHRO OUTPUT TO DIGITAL DATA CONVERTER.
 DC OUTPUT TO CHART RECORDER.

AMBIENT TEMPERATURE LIMITATIONS

WHIP ANTENNA COUPLER: - 28 to + 65° C (-18.4 to + 149° F).
 RECEIVER INDICATOR: 0 to + 50° C (32 to + 122° F).

POWER REQUIREMENTS: 115 v, 1 ph, 60 cyc, 12 amp; 300 v dc, 400 ma (two supplies are required).

NAVIGATIONAL SET OMEGA AN/WRN-2(XN-1)

MAJOR COMPONENTS

QTY	ITEM	DIMENSIONS (INCHES)	WEIGHT (LBS)
1	Navigational Set Omega AN/WRN-2(XN-1) includes:		
1	Receiver-Indicator includes:	17-1/4 x 19-1/2 x 57-1/2	486
1	1-MC Oscillator Mod RD-146	4-1/2 x 8 x 19	
1	10:1 Frequency Divider Mod RD-125		
2	Regulated Power Supplies Mod C-481	5-1/4 x 14-3/8 x 19	53
2	Monitor Oscilloscope Mod-K10R	5-1/4 x 11-3/8 x 19	21
1	Whip Antenna		
1	Whip Antenna Coupler	4-1/2 x 5-1/2 x 9	10
1	Rectilinear Recording Milliammeter (Dual Channel Chart Recorder)	9-1/2 x 13-3/4 x 16-1/2	47
1	Technical Manual NAVSHIPS 94409		
1	Instruction Book for Mod-K10R		
1	Instruction Book for Mod-RD-146 and Mod RD-125		
1	Instruction Book for Rectilinear Recording Milliammeter		
1	Instruction Book for Power Supplies Model C-481M		

REFERENCE DATA AND LITERATURE:

NAVSHIPS 94409: Technical Manual for Omega Navigational Set AN/WRN-2(XN-1).

SHIPPING DATA

PKGS	VOLUME (CU FT)	WEIGHT (LBS)
1	25	545
1	6.5	95
1	3.4	63
1	3.3	65

PROCUREMENT DATA

PROCURING SERVICE: USN

DESIGN COG: USN, BuShips

SPEC &/OR DWG:

CONTRACTOR

LOCATION

**CONTRACT OR
ORDER NO.**

**APPROX.
UNIT COST**

ITT Federal Laboratories

Nutley, N.J.

NObsr-81592

18 September 1967

RECEIVING SET, RADIO AN/WRR-2A

Cog Service: USN FSN:

Functional Class:

USA

USN

USAF

TYPE CLASS:

Used by

MANUFACTURER'S NAME/CODE NUMBER: National Radio Co. (42498)

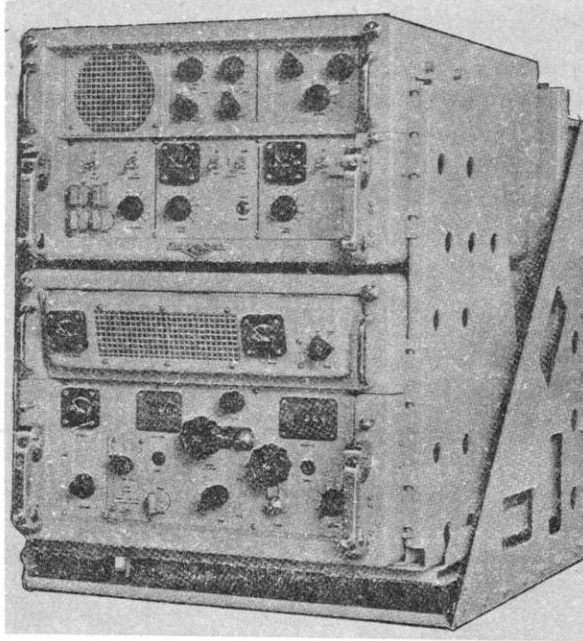

RECEIVING SET, RADIO AN/WRR-2A

FUNCTIONAL DESCRIPTION:

Receiving Set, Radio AN/WRR-2A is a triple-conversion superheterodyne receiver designed to operate in the frequency range of 2 to 32 mc. It is intended for shipboard installation in all classes and types of ships in the Navy, and is used for communications between ships, between ship and shore, and with aircraft. The receiver is intended primarily for the reception of single-sideband transmissions with full carrier suppression. It will also receive conventional AM signals of various types, including CW, MCW, voice, facsimile, and frequency-shift teletype. In order to meet present strict frequency tolerances, special features of the receiver provide extremely accurate tuning and a very high degree of stability over long periods of operation. Simultaneous use of both upper and lower sideband channels for receiving two different types of intelligence is possible, but not with single-sideband on AM signals.

No field changes in effect at time of preparation (2 Dec 67).

1.4 AN/WRR-2A: 1

RECEIVING SET, RADIO AN/WRR-2A

RELATION TO OTHER EQUIPMENT:

AN/WRR-2A is similar to but not interchangeable with AN/FRR-59A.

EQUIPMENT REQUIRED BUT NOT SUPPLIED:

(1) Headset NT49985A or equal; (1) Antenna; (As reqd) Cable, Coaxial RG10A/U; (As reqd) Cable, Power, type THFA or equal; (As reqd) Cable Power type DHFA; or equal.

TECHNICAL CHARACTERISTICS:

POWER REQUIREMENTS: 115 v, 50-60 cps, 1 ph, 2.17 amp, 250 W.

FREQUENCY RANGE: 2 mc to 32 mc inclusive, nom; overlap min.-1.9 mc to 32.1 mc inclusive.

TUNING BANDS: 4.

BAND RANGES: 2 to 4 mc; 4 to 8 mc; 8 to 16 mc; 16 to 32 mc.

TYPE OF FREQUENCY CONTROL

INCREMENTAL TUNING: 0.5 kc tuning increments controlled by a crystal std.

CONTINUOUS TUNING: 330 100-kc increments controlled by crystal std; lesser increments oscillator-controlled.

TYPES OF RECEPTION: A1 (on/off keyed cw); A2 (on/off keyed tone modulated cw); A3 (voice modulated cw); A9 (single-sideband); F1 (frequency-shift teletype, high-speed data transmission, and four-channel multiplex); F4 (facsimile).

MAX RECEIVER OUTPUT

AF LINE TERMINALS: 60 mw min into 600 ohm non-inductive resistive load.

PHONE JACKS: 15 mw max into 600 ohm non-inductive resistive load.

FREQUENCY-CONTROL CRYSTAL

TYPE: CR-36/U in HC-6/U holder.

OSCILLATOR FREQUENCY: 1 mc.

TEMP COEFFICIENT: 1 pt per million per deg C from +80°C to +90°C.

FREQ ACCURACY: ±0.0005% of nom freq at 85°C ±5 cps at 1 mc.

FREQUENCY STABILITY AND ACCURACY

INCREMENTAL TUNING: 1 pt in 10^7 per day.

CONTINUOUS TUNING: 1 pt in 10^7 ±150 cyc per day.

ANTENNA IMPEDANCE: 50 ohms.

HETERODYNE FREQ RANGE

HIGH FREQ OSCILLATOR: 3.725 mc to 33.725 mc.

INTERPOLATION OSCILLATOR: 680 kc to 580 kc.

IF FREQUENCIES

FIRST CONVERSION: 1625 kc to 1725 kc.

SECOND CONVERSION: 220 kc.

THIRD CONVERSION: 80 kc.

MAJOR COMPONENTS

QTY	ITEM	DIMENSIONS (INCHES)	WEIGHT (LBS)
1	Receiving Set, Radio, AN/WRR-2A includes:	19.80 x 22.56 x 23.06	250

1.4 AN/WRR-2A: 2

RECEIVING SET, RADIO AN/WRR-2A

QTY	ITEM	DIMENSIONS (INCHES)	WEIGHT (LBS)
1	Mounting MT-2293A/WRR-2	20.63 x 22 x 25	50
1	Converter, Frequency, Electronic CV920A/URR		
1	Amplifier, IF-AF, AM-2477A/URR		
5	Cables		
1 set	Miscellaneous Cable Connectors		
1 set	Mounting Cradle Hardware		
2	Technical Manuals NAVSHIPS 94715		
1	Maintenance Standards Book NAVSHIPS 94715.42		
1	Operating Instructions Chart NAVSHIPS 94715.21		

REFERENCE DATA AND LITERATURE:

NAVSHIPS 94715: Technical Manual for Radio Receiving Sets AN/WRR-2A and AN/FRR-59A.

SHIPPING DATA

PKGS	VOLUME (CU FT)	WEIGHT (LBS)
1	15.5	348
1	6.5	78

PROCUREMENT DATA

PROCURING SERVICE: USN
SPEC &/OR DWG:

DESIGN COG: USN, NavShips

CONTRACTOR	LOCATION	CONTRACT OR ORDER NO.	APPROX. UNIT COST
National Radio Co.	Melrose, Mass.	N0bsr-91085	

27 July 1964

Cog Service: USN

FSM: 2F5820-995-2974

RECEIVING SET, RADIO AN/WRR-3

Functional Class:

USA

USN

USAF

TYPE CLASS:

Std

MANUFACTURER'S NAME/CODE NUMBER: The Magnavox Company, (37695).

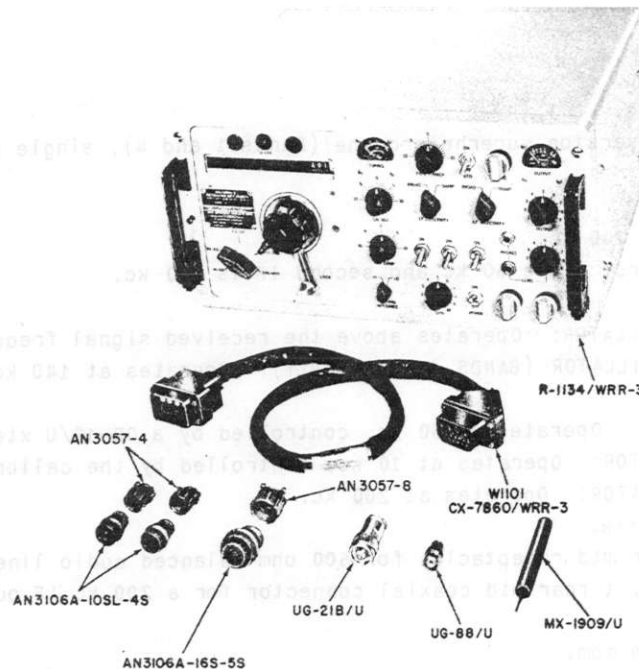

RECEIVING SET, RADIO AN/WRR-3

FUNCTIONAL DESCRIPTION:

Receiving Set, Radio AN/WRR-3 is a dual conversion superheterodyne receiver for shore, surface craft, and submarine installations. It receives three types of signals, cw, mcw, and fsk in the frequency range of 14 to 600 kc. The over-all frequency range of the receiver is divided into five bands. Each band has its own set of digital drum type dials. The band in use is indicated directly by the exposed set of dials. The audio output may be monitored by headphones at the receiver installation or by a remote speaker.

No field changes in effect at time of preparation (1 July 1964).

RELATION TO OTHER EQUIPMENT:

AN/WRR-3 RECEIVING SET, RADIO

EQUIPMENT REQUIRED BUT NOT SUPPLIED:

(1 or 2) Headset 49507; (1 or 2) AF Amplifier AM-215/U; (1) Converter-Comparator Group AN/URA-17; (1) Antenna Group AN/SRA-17 or AT-317/BRR.

TECHNICAL CHARACTERISTICS:

FREQUENCY BAND RANGES

- BAND 1: 14 to 30 kc.
- BAND 2: 30 to 63 kc.
- BAND 3: 63 to 133 kc.
- BAND 4: 133 to 283 kc.
- BAND 5: 283 to 600 kc.

RECEIVER TYPE: Dual conversion superheterodyne (Bands 1 and 4), single conversion superheterodyne (Bands 2, 3, 5).

INTERMEDIATE FREQUENCIES

- ON BANDS 2, 3 AND 5: 200 kc.
- ON BANDS 1 AND 4: First IF is 60 kc and second IF is 200 kc.

OSCILLATOR FREQUENCIES

- FIRST CONVERSION OSCILLATOR: Operates above the received signal frequency on all bands.
- SECOND CONVERSION OSCILLATOR (BANDS 1 AND 4 ONLY): Operates at 140 kc, controlled by a CR-18/U xtal.
- CALIBRATOR OSCILLATOR: Operates at 50 kc, controlled by a CR-18/U xtal.
- CALIBRATOR MULTIVIBRATOR: Operates at 10 kc, controlled by the calibrator oscillator.
- BEAT FREQUENCY OSCILLATOR: Operates at 200 kc.

RECEPTION: cw, mcw, and fsk.

RECEIVER OUTPUTS: 2 rear mtd receptacles for 600 ohm balanced audio line, 2 front panel mtd headphone connections, 1 rear mtd coaxial connector for a 200 kc IF output.

RECEIVER INPUTS

- LOW IMPEDANCE: 50 ohm nom.
- HIGH IMPEDANCE: 200 uuf nom capacitance.

POWER REQUIREMENTS: 105, 115, or 125 v; 50 to 60 cyc or 400 cyc, 60 W (115 v), 0.96 pf.

MAJOR COMPONENTS

QTY	ITEM	STOCK NUMBERS	DIMENSIONS (INCHES)	WEIGHT (LBS)
1	Receiving Set, Radio AN/WRR-3 includes:	2F5820-995-2974		
1	Receiver, Radio R-1134/WRR-3		8-3/4 x 16-3/4 x 17-1/4	69.5
1	Connector, Plug, Electrical AN3106A-16S-5S	9N5935-201-7973		
2	Connector, Plug, Electrical AN3106A-10SL-4S			
1	Connector, Plug, Electrical UG-88/U			
1	Connector, Plug, Electrical UG-21B/U	9N5935-149-4236		
2	Clamp AN3057-4			

AN/WRR-3: 2

RECEIVING SET, RADIO AN/WRR-3

QTY	ITEM	STOCK NUMBERS	DIMENSIONS (INCHES)	WEIGHT (LBS)
1	Clamp AN3057-8			
1	Cable Assy, Special Purpose, Electrical CX-7860/WRR-3			
1	Prod, Test MX-1909/U	2R6625-643-8546		

REFERENCE DATA AND LITERATURE:

NAVSHIPS 94543(A): Technical Manual for Radio Receiving Set AN/WRR-3.
 NAVSHIPS 94543.32: Performance Standards Sheet for Radio Receiving Set AN/WRR-3.
 NAVSHIPS 94543.42: Maintenance Standards Book for Radio Receiving Set AN/WRR-3.

TUBE, CRYSTAL AND/OR SEMI-CONDUCTOR DATA:

TUBES: (1) 6AN5WA (1) 6AU6WA (4) 6C4WA (1) 12AT7WA (3) 5725/6AS6W (5) 5749/6BA6W
 (1) 5751

CRYSTALS: (2) CR-18/U

SEMI-CONDUCTORS: (2) 1N458 (2) 1N459 (2) 1N547 (2) 1N2042-2 (1) 1N3004B

SHIPPING DATA

PKGS	VOLUME (CU FT)	WEIGHT (LBS)
1	4.168	123

PROCUREMENT DATA

PROCURING SERVICE: USN DESIGN COG: USN, BuShips
 SPEC &/OR DWG: SHIPS-R-3936; SHIPS-R-4333, Addend 1

CONTRACTOR	LOCATION	CONTRACT OR ORDER NO.	APPROX. UNIT COST
The Magnavox Company Pt No. 708552-801	Fort Wayne, Indiana	N0bsr-87060(FBM) N0bsr-89425	\$22767.10
Capehart Corporation	Richmond Hill, New York	N0bsr-91013(FBM)	\$2073.60

6 September 1967

Cog Service: USN

FSN:

RECEIVING SET, RADIO AN/WRR-3A

Functional Class:

USA

USN

USAF

TYPE CLASS:

Used by

MANUFACTURER'S NAME/CODE NUMBER: Clavier Corp. (97238).



RECEIVING SET, RADIO AN/WRR-3A

FUNCTIONAL DESCRIPTION:

Receiving Set, Radio AN/WRR-3A is a dual conversion superhetrodyne receiver for surface craft and submarine installation. It receives A1 (CW), A2(MCW) and F1 (FSK) signals. The receiver has a frequency range of 14 to 600 kc in five bands. Each band has its own set of digital drum type dials. The band in use is indicated directly by the exposed set of dials. The audio output may be monitored by headphones at the receiver installation or by a remote speaker. Interference from signals near the desired signal frequencies is minimized by the use of an intermediate frequency filter and an audio frequency filter. Noise is reduced by a noise peak limiter for improved intelligibility of received signals. A crystal-controlled calibration circuit provides accurate calibration at each 10 kc point throughout the tuning range.

No field changes in effect at time of preparation (27 December 1966).

RELATION TO OTHER EQUIPMENT:

The AN/WRR-3A is similar to and interchangeable w/ AN/WRR-3 except for maintenance parts.

EQUIPMENT REQUIRED BUT NOT SUPPLIED:

(1 or 2) Headset 49507 or equal; (1 or 2) AF Amplifier AM-215/U or equal; (1) FSK Converter AN/URA-17; (1) Antenna system AN/SRA-17 or AT-317/BRR or equivalent.

TECHNICAL CHARACTERISTICS:

FREQUENCY BAND RANGES

BAND 1: 14 to 30 kc.
 BAND 2: 30 to 63 kc.
 BAND 3: 63 to 133 kc.
 BAND 4: 133 to 283 kc.
 BAND 5: 283 to 600 kc.

RECEIVER TYPE: Dual conversion superhetrodyne on bands 1 and 4 and single conversion superhetrodyne on bands 2, 3, and 5.

INTERMEDIATE FREQUENCIES:

BANDS 2, 3, and 5: 200 kc.
 BANDS 1 and 4: First IF is 60 kc; 2nd IF is 200 kc.

OSCILLATOR FREQUENCIES

FIRST CONVERSION OSCILLATOR: Operates above the received signal freq on all bands.
 SECOND CONVERSION OSCILLATOR(BANDS 1 and 4 ONLY): Operates at 140 kc controlled by type CR18/U crystal.
 CALIBRATOR OSCILLATOR: Operates at 50 kc, controlled by type CR-18/U crystal.
 CALIBRATOR MULTIVIBRATOR: Operates at 10 kc, controlled by calibrator oscillator.
 BEAT FREQUENCY OSCILLATOR: Operates at 200 kc.

RECEPTION: A1(CW), A2(MCW), and F1(FSK).

RECEIVER OUTPUTS: Two rear mtd receptacles for 600 ohm balanced audio line; two front mtd headphone connections; rear mtd coaxial connector for a 200 kc IF output.

RECEIVER INPUTS

LOW IMPEDANCE: 50 ohm nom.
 HIGH IMPEDANCE: 200 uuf nom capacitance.

POWER REQUIREMENTS: 105, 115, or 125 v ac, single ph, 50 to 60 cyc, or 400 cyc, 0.58 amp (at 115 v ac), 0.90 pf, 60 W.

MAJOR COMPONENTS

QTY	ITEM	DIMENSIONS (INCHES)	WEIGHT (LBS)
1	Receiving Set, Radio, AN/WRR-3A, includes:	8.75 x 16.75 x 17.25	69.5
1	Connector, MS3106A-16S-5S		
2	Connector, MS3106A-10SL-4S		
1	Connector UG-88/U		
1	Connector UG 21B/U		
2	Clamp MS3057-4B		

1.4 AN/WRR-3A: 2

UNCLASSIFIED
ELECTRONIC EQUIPMENT - PRELIMINARY DATA
NAVSHIPS 4457 (Rev. 9-62) (CONT'D)

NAVSHIPS 93400

DESIGNATION	ITEM NAME
AN/WRR-4(XN-1)	Radio Receiving Set

FUNCTIONAL DESCRIPTION: SKETCH, MFG. DIMENSIONS, ETC.

The AN/WRR-4(XN-1) receives the transmitted signal from shore station very low frequency transmitter and reduces it to printed page copy. It is a seaborne installation. This equipment is part of Multiplex Communication System AN/WRC-2 (). It is used with, but is not a part of, one to four teletypewriter page printers.

No unit cost available.

Source of information: Request for Nomenclature
Contract
Nomenclature correspondence

25 August 1967

Cog Service: USN FSN:

TRANSMITTING SET, RADIO AN/WRT-1A

Functional Class:

USA

USN

USAF

TYPE CLASS:

Used by

MANUFACTURER'S NAME/CODE NUMBER: Hoffman Electronics Corp., (82260).
Rixon Electronics Inc., (00433).

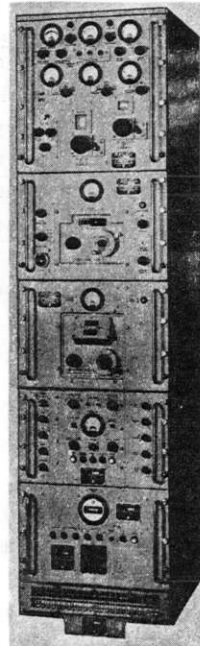

TRANSMITTING SET, RADIO AN/WRT-1A

FUNCTIONAL DESCRIPTION:

The Transmitting Set, Radio AN/WRT-1A is a communication equipment designed to be installed aboard surface vessels. The transmitter is continuously tunable through the frequency range of 300 to 1500 kc and is capable of supplying a nominal peak power output of at least 500 w into a 50.ohm resistive load with a VSWR of less than 4 to 1, and has the following emission capabilities; telephone, FSK (neutral) teletype at 60 wpm and Mod cw for beacon applications machine telegraphy at 600 wpm.

No field changes in effect at time of preparation (27 May 1966).

RELATION TO OTHER EQUIPMENT:

The AN/WRT-1A is one-way interchangeable with AN/WRT-1 and AN/WRT-2.

EQUIPMENT REQUIRED BUT NOT SUPPLIED:

(1) Antenna; (1) Radiophone Unit 23500 or equivalent; (1) Telegraph-Key 26012; (1) Hand-set (carbon) H-J/U; (2) Multimeter AN/PSM-4 series; (1) Electronic Multimeter AN/USM-116 series; (1) Electronic Counter Hewlett-Packard Model 524 series w/Model 525 series Plug-in Units; (1) Frequency Standard AN/URQ-9 series; (1) Oscilloscope AN/URQ-9 series; (1) Audio Oscillator AN/URM-127 series; (1) Spectrum Analyzer TS-1379/U; (1) Electrical Dummy Load DA-91 series; (1) Tube-Tester TV-7 series; (1) Battery BA-234/U; (1) Vari-Speed Keyer Boehme Type 66M.

TECHNICAL CHARACTERISTICS:

FREQUENCY RANGE: 300 to 1500 kc.

FREQUENCY CONTROL: Accomplished by phase-comparison circuits in conjunction with an interpolation oscillator.

TYPE OF EMISSION: Machine cw, cw, frequency shift-keyed teletype, AM speech.

CW CHARACTERISTICS: When connected to a machine cw (on-off) keyer, it is capable of operating on a dc keying voltage (negative side grounded) of 30 v porm 1.5 to 135 v porm 6.75 at the rate of 60 words per minute; it may be hand-keyed at keying speeds up to a maximum of 30 wpm. Wave-shaping circuits are provided for adjusting the rise and decay time of the output pulse for machine cw keying, teletype and multiple operation over the range of 100 to 5000 microseconds. Provision is made for slow speed tone modulated cw by a build in 1000 cycle tone generator which is capable of 100% modulation of a reduced carrier level to give output of 187 watts.

FSK CHARACTERISTICS

NEUTRAL KEYING SIGNALS: 0 to 30 porm 1.5 v dc up to 135 ± 6.75 volts dc at the rate of 60 wpm.

FREQUENCY SHIFT DEVIATION: Adjustable up to ± 500 cps from the carrier frequency.

SWEEP RATE: 200 cps with a maximum displacement at the transmitter output of zero to one radian (approximately 60 degrees).

POWER OUTPUT: 500 W when connected to a 500 ohm resistive load having a standing-wave ratio of less than 4 to 1.

FREQUENCY STABILITY: 30 cps ± 1.5 cps per mc, when operating at normal line voltage and frequency in an ambient temperature range of 25 to 35 degrees C (77 to 95 degrees F) and any relative humidity of 40 to 90 percent over a 24 hour period.

POWER REQUIREMENTS: 115, 220 or 440 v porm 10%, 60 cyc, 3 phase.

HEAT DISSIPATION

100 W OPERATION: 1.16 kw.

500 W OPERATION: 1.52 kw.

MAJOR COMPONENTS

QTY	ITEM	DIMENSIONS (INCHES)	WEIGHT (LBS)
1	Radio Transmitting Set AN/WRT-1A includes:		
1	Transmitter-Group OA-2321A/WRT-1	21 x 29-1/2 x 72	1030
1	Radio Frequency Tuner TN-345/WRT-1	13-3/8 x 16-15/16 x 48-7/8	120

TRANSMITTING SET, RADIO AN/WRT-1A

QTY	ITEM	DIMENSIONS (INCHES)	WEIGHT (LBS)
1	Antenna Coupler CU-760/WRT-1	13-3/8 x 16-15/16 x 22-1/2	80
1	Connector P101, MS-3106 B-32-7P		
1	Connector P102		
1	Connector P103 UG-943/U		
1	Connector P104 UG-943A/U		
1	Connector P3301 AN-3106E-32-8S		
1	Connector P3501 AN-3106E-24-28S		
1	Mounting MT-2170A/WRT, Maintenance Parts Kit		
2	Technical Manuals NAVSHIPS 95900(A) and NAVSHIPS 0281-072-5401		

REFERENCE DATA AND LITERATURE:

NAVSHIPS 95900(A): Technical Manual for Radio Transmitting Set AN/WRT-1A.
NAVSHIPS 0281-072-5401 CHANGE 1.

SHIPPING DATA

PKGS	VOLUME (CU FT)	WEIGHT (LBS)
1	55	1130
1	12.4	196
1	6.5	120
	2.5	76
3	1.2	444
	0.7	34

PROCUREMENT DATA

PROCURING SERVICE: USN
SPEC &/OR DWG:

DESIGN COG: USN, NavShips

CONTRACTOR	LOCATION	CONTRACT OR ORDER NO.	APPROX. UNIT COST
Hoffman Electronics Corp.	El Monte, California	NObsr 91020	
Rixon Electronics Inc.	Silver Spring, Maryland	NObsr 89188	

715

9 January 1967

Cog Service: USN FSN:

TRANSMITTING SET RADIO AN/WRT-4(XN-3)

Functional Class:

USA

USN

USAF

TYPE CLASS:

Used by

MANUFACTURER'S NAME/CODE NUMBER: Hoffman Electronics Corporation, Military Products Division, (82260).

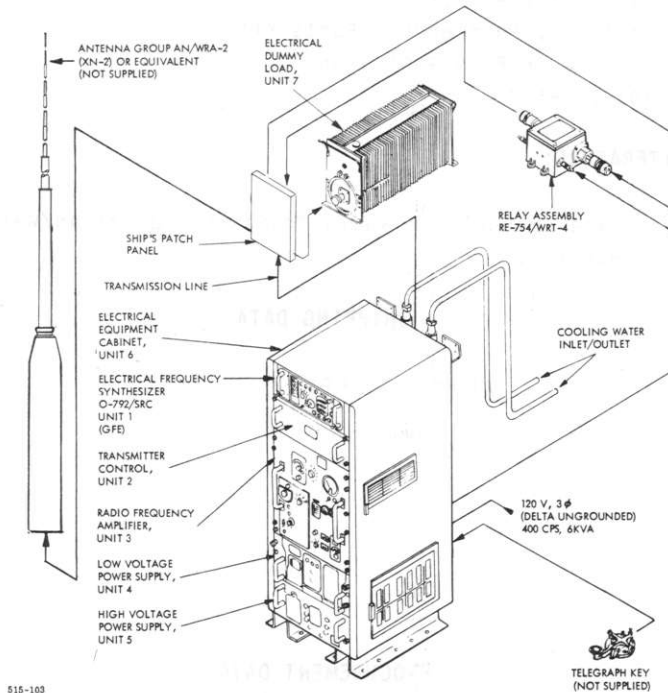

TRANSMITTING SET RADIO AN/WRT-4(XN-3)

FUNCTIONAL DESCRIPTION:

The Transmitting Set, Radio AN/WRT-4(XN-3) is a light weight, water cooled, continuous wave transmitter, having a frequency range from 2 to 32 megacycles and a RF power output of 1 kw. The operation of the transmitter is conventional. The synthesizer generates a carrier within the frequency range from 2 to 32 megacycles and applies it to the radio frequency amplifier for amplification and keying. Although primarily designed for use with Antenna Group AN/WRA-2(XN-2) and for installation in undersurface vessels, the transmitter can be used in any facility having the proper power source, water, and antenna requirements.

No field changes in effect at time of preparation (24 May 1966).

RELATION TO OTHER EQUIPMENT: None.

TRANSMITTING SET RADIO AN/WRT-4(XN-3)

EQUIPMENT REQUIRED BUT NOT SUPPLIED:

(1) Antenna Group (or equivalent) AN/WRA-2(XN-2); (1) Telegraph Key; (1) Bulk Cable RG-17A/U(W-1); (1) Bulk Cable, TSGA-40(W-2); (1) Bulk Cable, W-3; (1) Technical Manual NAVSHIPS 93792; (1) Technical Manual NavShips 93797.

TECHNICAL CHARACTERISTICS:

TYPE OF TRANSMISSION: CW, A1 emission.

FREQUENCY RANGE: 2 to 32 mc.

ACCURACY: One part in 10^8 .

POWER OUTPUT: 1000 W.

POWER SOURCE REQUIRED: 120 v ac, 400 cps, 3 ph, 10 kw.

HEAT DISSIPATION: Approximately 9 kw into the cooling water; under emergency operating conditions, with side vents open, 9 kw into the room.

TYPE OF FREQUENCY CONTROL: Crystal and reactance controlled (Electrical Frequency Synthesizer 0-792/SRC).

AMBIENT TEMPERATURE LIMITATIONS: The transmitter will operate satisfactorily within an ambient temperature range of 0 deg to 50 deg C (32 deg to 122 deg F).

COOLANT REQUIREMENTS: Requirements for the transmitter heat exchangers are: portable water, below 35 deg C (95 deg F), at 30 psi pressure and 9 gpm flow rate.

MAJOR COMPONENTS

QTY	ITEM	DIMENSIONS (INCHES)	WEIGHT (LBS)
1	Transmitting Set, Radio AN/WRT-4(XN-3) includes:		
1	Electrical Dummy Load, Unit 7	6-3/8 x 10-3/8 x 28	40
1	Electrical Equipment Cabinet, (Units 1 through 5 installed), Unit 6	23-1/8 x 28-1/2 x 57-3/4	1100
1	Electrical Frequency Synthesizer 0-792/SRC (Government Furnished Equipment), Unit 1	5-1/4 x 17-1/4 x 21-1/2	90
1	Transmitter Control, Unit 2	7 x 19 x 20-3/4	9.5
1	Radio Frequency Amplifier, Unit 3	19 x 21 x 21-1/2	116
1	Low Voltage Power Supply, Unit 4	8-1/2 x 17 x 20	90
1	High Voltage Power Supply, Unit 5	6-13/16 x 17 x 21-3/4	210
1	Relay Assembly, RE-754/WRT-4	3-3/4 x 5-7/16 x 6-5/8	3
2	Technical Manuals NAVSHIPS 94395	1 x 9 x 11-1/2	2
4	Eye Bolts		

REFERENCE DATA AND LITERATURE:

NAVSHIPS 94395: Technical Manual for Radio Transmitting Set AN/WRT-4(XN-3).

TRANSMITTING SET RADIO AN/WRT-4(XN-3)

SHIPPING DATA

PKGS	VOLUME (CU FT)	WEIGHT (LBS)
1	36.7	1220
1	5.3	75

PROCUREMENT DATA

PROCURING SERVICE: USN
SPEC &/OR DWG: SHIPS-R-2653A

DESIGN COG: USN, NavShips

CONTRACTOR	LOCATION	CONTRACT OR ORDER NO.	APPROX. UNIT COST
Hoffman Electronics Corp., Military Products Div.	El Monte, California	N0bsr-85256 N0bsr-87677 N0bsr-89471	

28 July 1964

MONITORING SET, NOISE (PUMP) AN/WSQ-3

Cog Service: USN FSN: 2F6625-777-3530

Functional Class:

USA

USN

USAF

TYPE CLASS:

Used by

MANUFACTURER'S NAME/CODE NUMBER: Dyna-Empire, Inc., (90827).

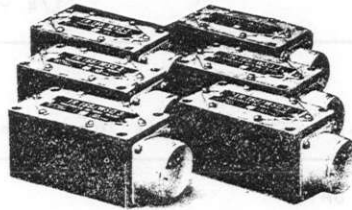
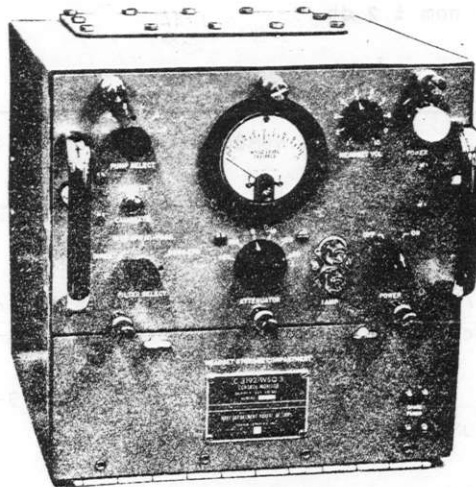

MONITORING SET, NOISE (PUMP) AN/WSQ-3

FUNCTIONAL DESCRIPTION:

Monitoring Set, Noise (Pump) AN/WSQ-3 is an electronic system which is used to detect the presence and measure the amplitude of the noise developed by the primary coolant pumps employed in nuclear power plants.

No field changes in effect at time of preparation (28 May 1964).

RELATION TO OTHER EQUIPMENT:

EQUIPMENT REQUIRED BUT NOT SUPPLIED:

AN/WSQ-3 MONITORING SET, NOISE (PUMP)

TECHNICAL CHARACTERISTICS:

FREQUENCY RANGE: 30 cps to 15 kcps.

OUTPUT PRESENTATIONS: Meter, aural.

INPUT POWER: 115 v \pm 10%, 60 cps \pm 5%, 1 ph, 8 W.**TRANSDUCER**

TYPE: Lead Zirconium Titanate orthogonal, tri-axial accelerometer.

SENSITIVITY: 4.9 mv/g (RMS) nom \pm 2 db.**MAJOR COMPONENTS**

QTY	ITEM	STOCK NUMBERS	DIMENSIONS (INCHES)	WEIGHT (LBS)
1	Monitoring Set, Noise (Pump) AN/WSQ-3 includes:	2F6625-777-3530		
1	Control Monitor C-3192/WSQ-3		12 x 11-1/2 x 11-29/32	38
6	Transducer Motional Pick-up TR-168/WSQ-3		2 x 2 x 4-3/16	2.5
6	Cable Plugs, Assy No. 10-109624-17S per BuShips Dwg RE49D796		1-5/8 x 3-3/16	0.3
4	Transducer Mounting Bolts AN500AC416-40			
4	Lock-washers split		1/4 x 1/16	

REFERENCE DATA AND LITERATURE:

NAVSHIPS 93715: Technical Manual for Monitoring Set, Noise (Pump) AN/WSQ-3.

TUBE, CRYSTAL AND/OR SEMI-CONDUCTOR DATA:

TUBES: (1) CHS6111

CRYSTALS: Not required.

SEMI-CONDUCTORS: (1) 1N430 (2) 1N647 (6) 1N645 (5) 2N335 (3) 2N341 (1) 2N498

SHIPPING DATA

PKGS	VOLUME (CU FT)	WEIGHT (LBS)
1	2	78
1	1.3	25

PROCUREMENT DATAPROCURING SERVICE: USN
SPEC &/OR DWG: SHIPS-P-3389

DESIGN COG: USN, BuShips

CONTRACTOR	LOCATION	CONTRACT OR ORDER NO.	APPROX. UNIT COST
Dyna-Empire, Inc.	Garden City, New York	NObsr-75948 (FBM), 29 June 1959	



22 November 1965

Cog Service: USN

FSN: 2F6665-987-9748

MONITORING SET, NOISE (PUMP) AN/WSQ-3A

Functional Class:

USA

USN

USAF

TYPE CLASS:

Used by

MANUFACTURER'S NAME/CODE NUMBER: Dyna-Empire, Inc., (90827).

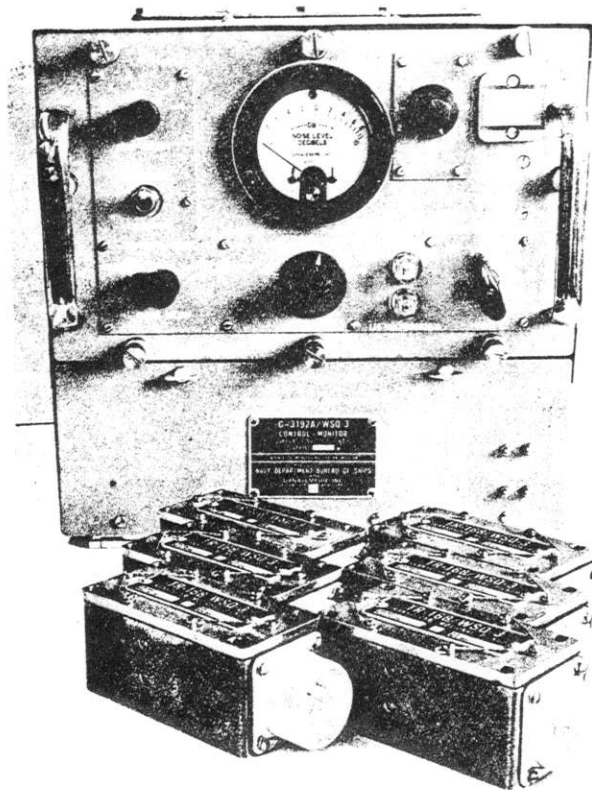

MONITORING SET, NOISE (PUMP) AN/WSQ-3A

FUNCTIONAL DESCRIPTION:

Monitoring Set, Noise (Pump) AN/WSQ-3A is an electronic system which is used to detect the presence and measure the amplitude of the noise developed by the primary coolant pump employed in nuclear power plants.

Vibrations developed by any one of the main coolant pumps, accelerate a transducer which is bolted and sealed to the pump housing. Crystal elements within the transducer respond to this stimulus and convert it into an electrical signal which is conveyed to the Control-Monitor unit through an inter-connecting cable. Within the Control-Monitor an amplifier is selectively connected to any one of the six Transducers which it is designed to accommodate. The amplified signal may be monitored aurally by a headset or visually by a calibrated meter.

No field changes in effect at time of preparation (15 June 1964).

RELATION TO OTHER EQUIPMENT: None.

EQUIPMENT REQUIRED BUT NOT SUPPLIED:

Interconnecting Cables PI-3 as required.

TECHNICAL CHARACTERISTICS:

FREQUENCY RANGE: 30 to 15000 cps.

OUTPUT PRESENTATIONS: Meter, aural.

INPUT POWER: 115 v \pm 10%, 60 cps \pm 5%, single ph, 8 W.

TRANSDUCER CHARACTERISTICS

TYPE: Lead Zirconium Titanate, orthogonal tri-axial accelerometer.

SENSITIVITY: 4.9 m v/g (rms) nom \pm 2 db.

MAJOR COMPONENTS

QTY	ITEM	STOCK NUMBERS	DIMENSIONS (INCHES)	WEIGHT (LBS)
1	Monitoring Set, Noise (Pump) AN/WSQ-3A includes:	2F6665-987-9748		
1	Control Monitor C-3192A/WSQ-3		11-1/2 x 11-29/32 x 12	38
6	Transducer, Motional Pick- up TR-168/WSQ-3		2 x 2 x 4-3/16	2.5
6	Cable Plugs Assy No. 10-109624-17A per BuShips dwg RE49D796		1-5/8 x 3-3/16	0.3
4	Transducer mounting bolts AN500AC 416-40			
4	Lock-washers split 1/4 x 1/16 Epoxy Adhesive for Trans- ducer mounting			

REFERENCE DATA AND LITERATURE:

NAVSHIPS 94542: Service Manual for Monitoring Set, Noise (Pump) AN/WSQ-3A.

TUBE, CRYSTAL AND/OR SEMI-CONDUCTOR DATA:

TUBES: Not required.

CRYSTALS: Not required.

SEMI-CONDUCTORS: (1) 1N429 (4) 1N645 (7) 2N335 (1) 2N498 (3) 2N1613

SHIPPING DATA

PKGS	VOLUME (CU FT)	WEIGHT (LBS)
1	2	78
1	1.3	25

PROCUREMENT DATA

PROCURING SERVICE: USN
 SPEC &/OR DWG:

DESIGN COG: USN, BuShips

CONTRACTOR	LOCATION	CONTRACT OR ORDER NO.	APPROX. UNIT COST
Dyna-Empire, Inc.	Garden City, N. Y.	N0bsr 87130 (FBM) 27 Nov 1961	

26 August 1965

ANTENNA AS-725(XN-1)/S

Cog Service: USN FSN:

Functional Class:

USA

USN

USAF

TYPE CLASS:

Used by

MANUFACTURER'S NAME/CODE NUMBER: Turnbull Elevator Company, Incorporated, (63914).

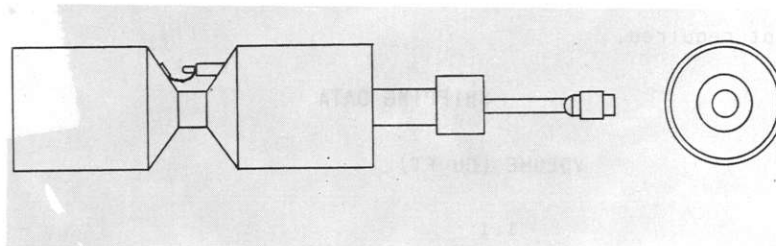

ANTENNA AS-725(XN-1)/S

FUNCTIONAL DESCRIPTION:

Antenna AS-725(XN-1)/S is an around-the-mast type antenna for use on aircraft rescue boats and other small craft. The unit is in one section, fixed non-telescoping, dripproof, and fabricated from a light gray finished aluminum. The antenna is mounted by means of a 2-inch pipe thread. A tap permits installation of a range light on the masthead.

No field changes in effect at time of preparation (18 August 1965).

RELATION TO OTHER EQUIPMENT:

AS-725(XN-1)/S is similar to Antenna AS-468/B electrically, but the two are not interchangeable.

EQUIPMENT REQUIRED BUT NOT SUPPLIED:

(1) Navy Type No. R168 range light; (1) 2 inch standard pipe support (for mounting antenna on boat).

30 August 1965

ANTENNA AS-768A/GR

Cog Service: USN FSN:

Functional Class:

USA

USN

USAF

TYPE CLASS:

Used by

MANUFACTURER'S NAME/CODE NUMBER: Amerac Incorporated, (96955).



ANTENNA AS-768A/GR

FUNCTIONAL DESCRIPTION:

Antenna AS-768A/GR is a vertically stacked antenna array designed for radio transmission and reception in the frequency range of 225 to 440 megacycles. It is used for communication with aircraft at Naval Air Stations. This vertically stacked antenna array gives a circular radiation pattern in the horizontal plane with the point of maximum radiation four degrees above the optical line of sight.

The antenna is made up of 16 center-fed Hertz antennas (dipoles) mounted vertically, with four dipoles on each level. The four dipoles are mounted on circular antenna plates and are 90 degrees apart. Each set of four dipoles is displaced 45 degrees in order to give complete antenna coverage for 360 degrees.

No field changes in effect at time of preparation (11 August 1965).

RELATION TO OTHER EQUIPMENT:

AS-768A/GR is electrically and mechanically interchangeable with AS-768/GR and AS-768B/GR. The antennas differ in the plate feeder and in the transformer system.

ANTENNA AS-768A/GR

EQUIPMENT REQUIRED BUT NOT SUPPLIED: None.

TECHNICAL CHARACTERISTICS:

FREQUENCY RANGE: 225 to 400 mc.

INPUT IMPEDANCE: 50 ohms at 300 mc.

STANDING WAVE RATIO: 2 to 1 max.

RADIATION PATTERN

HORIZONTAL: Circular, 0 to 360°.

VERTICAL: 15° at 300 mc; Point of max radiation 4° above optical line of sight.

MAJOR COMPONENTS

QTY	ITEM	DIMENSIONS (INCHES)	WEIGHT (LBS)
1	Antenna AS-768A/GR	14-7/8 dia x 126-5/8	140

REFERENCE DATA AND LITERATURE:

NAVSHIPS 93137(A): Technical Manual for Antennas AS-768/GR, AS-768A/GR and AS-768B/GR.

TUBE, CRYSTAL AND/OR SEMI-CONDUCTOR DATA:

TUBES: Not required.

CRYSTALS: Not required.

SEMI-CONDUCTORS: Not required.

SHIPPING DATA

PKGS	VOLUME (CU FT)	WEIGHT (LBS)
1	33.7	300

PROCUREMENT DATA

PROCURING SERVICE: USN
SPEC &/OR DWG:

DESIGN COG: USN, BuShips

CONTRACTOR	LOCATION	CONTRACT OR ORDER NO.	APPROX. UNIT COST
Amerac Incorporated	Beverly, Massachusetts	N0bsr 75842	\$429.00

26 August 1965

ANTENNA AS-768B/GR

ANTENNA AS-768B/GR

Cog Service: USN FSN:

Functional Class:

USA

USN

USAF

TYPE CLASS:

Used by

MANUFACTURER'S NAME/CODE NUMBER: Amerac Incorporated, (96955).

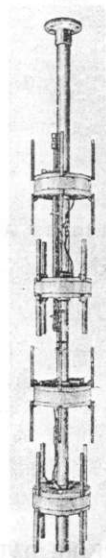

ANTENNA AS-768B/GR

FUNCTIONAL DESCRIPTION:

Antenna AS-768B/GR is a vertically stacked antenna array designed for radio transmission and reception in the frequency range of 225 to 400 megacycles. It is used for communication with aircraft at Naval air stations. This vertically stacked antenna array gives a circular radiation pattern in the horizontal plane with the point of maximum radiation four degrees above the optical line of sight.

The antenna is made up of 16 center-fed Hertz antennas (dipoles) mounted vertically, with four dipoles on each level. The four dipoles are mounted on circular antenna plates and are 90° apart. Each set of four dipoles is displaced 45° in order to give complete antenna coverage for 360°.

No field changes in effect at time of preparation (11 August 1965).

RELATION TO OTHER EQUIPMENT:

AS-768B/GR is electrically and mechanically interchangeable with AS-768/GR and AS-768A/GR. The antennas differ in the plate feeder and in the transformer system.

ANTENNA AS-768B/GR

EQUIPMENT REQUIRED BUT NOT SUPPLIED: None.

TECHNICAL CHARACTERISTICS:

FREQUENCY RANGE: 225 to 400 mc.

INPUT IMPEDANCE: 50 ohms at 300 mc.

STANDING WAVE RATIO: 2 to 1 max.

RADIATION PATTERN

HORIZONTAL: Circular, 0 to 360°.

VERTICAL: 15° at 300 mc; Point of max radiation 4° above optical line of sight.

MAJOR COMPONENTS

QTY	ITEM	DIMENSIONS (INCHES)	WEIGHT (LBS)
1	Antenna AS-768B/GR	14-7/8 dia x 126-5/8	140

REFERENCE DATA AND LITERATURE:

NAVSHIPS 93137(A): Technical Manual for Antennas AS-768/GR, AS-768A/GR and AS-768B/GR.

TUBE, CRYSTAL AND/OR SEMI-CONDUCTOR DATA:

TUBES: Not required.

CRYSTALS: Not required.

SEMI-CONDUCTORS: Not required.

SHIPPING DATA

PKGS	VOLUME (CU FT)	WEIGHT (LBS)
1	33.7	300

PROCUREMENT DATA

PROCURING SERVICE: USN

DESIGN COG: USN, BuShips

SPEC &/OR DWG: SHIPS-A-3219 Mod

CONTRACTOR	LOCATION	CONTRACT OR ORDER NO.	APPROX. UNIT COST
Amerac Incorporated	Beverly, Massachusetts	N0bsr 75842	\$429.00

730

23 April 1965

ANTENNA AS-1059/ASQ-19

Cog Service: USN

FSN:

Functional Class:

USA

USN

USAF

TYPE CLASS:

Used by

MANUFACTURER'S NAME/CODE NUMBER: Collins Radio Company, (13499).

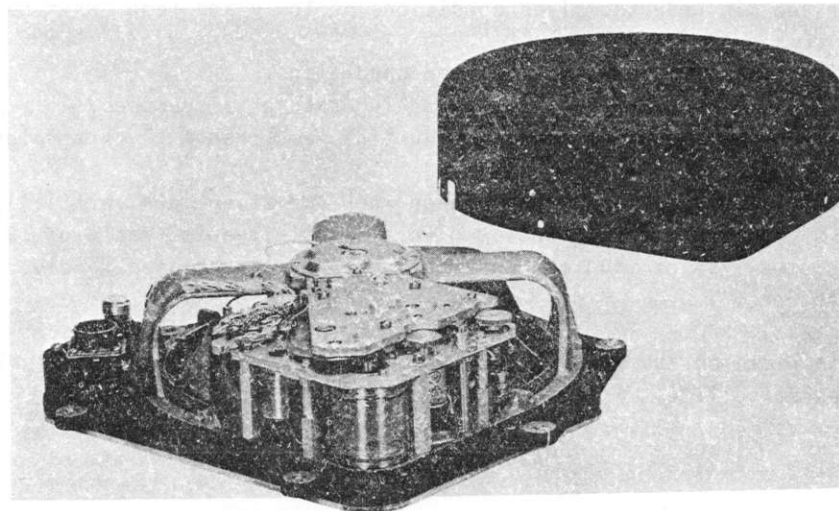

ANTENNA AS-1059/ASQ-19

FUNCTIONAL DESCRIPTION:

Antenna AS-1059/ASQ-19 is a lightweight, airborne, direction-finding antenna operated in the UHF range between 225 and 400 mc. The antenna is designed to be used in conjunction with other equipment for automatic direction-finding and communications applications.

No field changes in effect at time of preparation (9 March 1965).

RELATION TO OTHER EQUIPMENT: None.

EQUIPMENT REQUIRED BUT NOT SUPPLIED: None.

TECHNICAL CHARACTERISTICS:

FREQUENCY RANGE: 225 mc to 400 mc.

ALTITUDE: Normal operation up to 70,000 ft.

1.1 AS-1059/ASQ-19: 1

ANTENNA AS-1059/ASQ-19

TEMPERATURE: Continuous operating from - 55° C (- 67° F) to + 100° C (+ 212° F) w/10 minute operation up to 125° C (257° F).

HUMIDITY: Normal operation up to 95% humidity.

SHOCK: 15 G, 11 ms duration operation; 30 G, 11 ms duration crash safety; 5 G, 1 sec duration, max acceleration attained; in 0.1 - sec operation.

VIBRATION: 0.1 in. double amplitude, 10 - 44 cps ± 10 G, 44 - 1000 cps. Intermittent 50 G shock of 5 ms duration imposed on steady state vibration.

ACOUSTICAL NOISE: Satisfactory operation at a sound pressure level (jet exhaust) of 150 db above 0.002 dyne per sq cm.

AC POWER REQUIREMENTS: 115 v, 400 cps, single ph, operating limits 102 to 124 v, 380 to 420 cps. 26 v, 400 cps, single ph. Operating limits 23.4 to 28.6 v, 380 to 420 cps.

DC POWER REQUIREMENTS: 6.3 v 100 cps; 27.5 v, 0.2 W.

AMOUNT OF BEARING INDICATION: 360°.

SPEED OF INDICATION: 30° per sec min when bearing is 50° to 179° from the starting point. (This is the design spec requirement). The avg speed of indication is 60° per sec under normal operating conditions. 12° per sec min when bearing is 10° to 50° from the starting point. 25° per sec min under combined conditions of low v and temp, when bearing is 50° to 179° from the starting point.

BEARING ACCURACY: ± 5° max error under service conditions.

INDICATION LAG: Less than 5° at an aircraft turning rate of 3° per sec.

INDICATION HUNTING: Overshoot less than 10°. Hunting less than ± 1° on straight, level flight.

SENSITIVITY: Satisfactory bearings can be taken when operating in a vertically polarized, RF field w/ a signal level sufficient to give a signal-to-noise ratio of 10 db when the signal is modulated. 30% at 1000 cps and applied to the associated receiver through a quarter-wave antenna.

OPERATIONAL STABILITY: 200 hr(s) of operation without readjustment, nonaccessible controls.

OPERATIONAL LIFE: A min of 500 hr(s) without removal for bench servicing. A min of 2000 hr(s) total operating life.

MAJOR COMPONENTS

QTY	ITEM	STOCK NUMBERS	DIMENSIONS (INCHES)	WEIGHT (LBS)
1	Antenna AS-1059/ASQ-19		3-5/8 x 11-1/4 x 12-1/2	9.5

REFERENCE DATA AND LITERATURE:

NAVWEPS 16-35AS1059-2 & NAVWEPS 16-35AS1059-1: Handbook Overhaul Instructions Antenna AS-1059/ASQ-19.

TUBE, CRYSTAL AND/OR SEMI-CONDUCTOR DATA:

TUBES: Not required.

CRYSTALS: Not required.

SEMI-CONDUCTORS: Not required.

ANTENNA AS-1059/ASQ-19

SHIPPING DATA

PKGS _____ VOLUME (CU FT) _____ WEIGHT (LBS) _____

PROCUREMENT DATA

PROCURING SERVICE: USN
SPEC &/OR DWG:

DESIGN COG: USN, BuWeps

CONTRACTOR	LOCATION	CONTRACT OR ORDER NO.	APPROX. UNIT COST
Collins Radio Company	Cedar Rapids, Iowa	NOW 60-0100 NOW 60-0540 NOW 61-0034 NOW 61-0574 NOW 62-0212 NOW 62-0816 NOW(a) 63-0424	

4 May 1966

Cog Service: USN

FSM:

ANTENNA AS-1065/UPX(XN-1)

Functional Class:

USA

USN

USAF

TYPE CLASS:

Used by

MANUFACTURER'S NAME/CODE NUMBER: I. T. E. Circuit Breaker Co., Special Products Div., (30086).

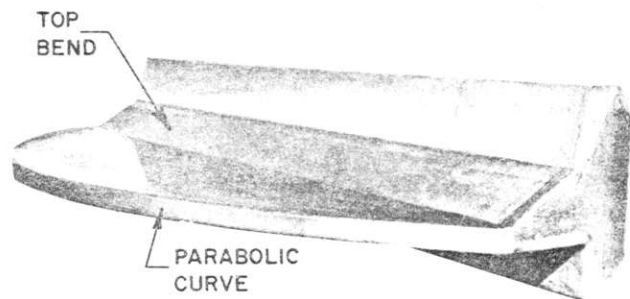
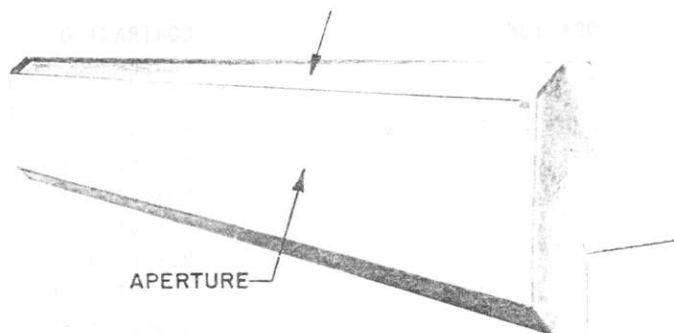

ANTENNA AS-1065/UPX(XN-1)

FUNCTIONAL DESCRIPTION:

The AS-1065/UPX(XN-1) is a folded dipole type, pedestal mounted antenna for IFF use. The unit operates in conjunction with recognition equipment as part of an IFF interrogation system. The antenna transmits and receives standard pulse or semicontinuous radio frequency energy.

No field changes in effect at time of preparation (15 February 1966).

RELATION TO OTHER EQUIPMENT: None.

EQUIPMENT REQUIRED BUT NOT SUPPLIED: None.

TECHNICAL CHARACTERISTICS:

FREQUENCY RANGE

ANTENNA AS-1065/UPX(XN-1)

TRANSMITTER: 1030 mc, \pm 60 mc.
 RECEIVER: 1090 mc, \pm 60 mc.
 ANTENNA OR TRANSDUCER: Folded dipole type, pillbox type.
 EMISSION: Pulse type.
 INPUT IMPEDANCE: 50 ohms.
 OUTPUT IMPEDANCE: 50 ohms.
 POWER OUTPUT: 10 kw peak at 25% duty cycle.

MAJOR COMPONENTS

QTY	ITEM	STOCK NUMBERS	DIMENSIONS (INCHES)	WEIGHT (LBS)
1	Antenna AS-1065/UPX(XN-1) includes:		3-9/16 to 18-7/16 x 39-5/16 x 10-1/2	79
1	Low Pass L-Band Filter		3/8 x 8-7/8	4 oz.
1	Radio Frequency Cable			8 oz.

REFERENCE DATA AND LITERATURE:

NAVSHIPS 93560: Technical Manual for Antenna AS-1065/UPX.

SHIPPING DATA

PKGS	VOLUME (CU FT)	WEIGHT (LBS)
1	72	300

PROCUREMENT DATA

PROCURING SERVICE: USN
 SPEC &/OR DWG: MIL-A-21327(SHIPS)

DESIGN COG: USN, BuShips

CONTRACTOR	LOCATION	CONTRACT OR ORDER NO.	APPROX. UNIT COST
I. T. E. Circuit Breaker Co. Special Products Div.	Philadelphia 34, Pa.	N0bsr 75746	

3 August 1965

Cog Service: USN

FSN:

Functional Class:

ANTENNA AS-1390/U

USA

USM

USAF

TYPE CLASS:

Used by

MANUFACTURER'S NAME/CODE NUMBER: CHU Associates, (04953).

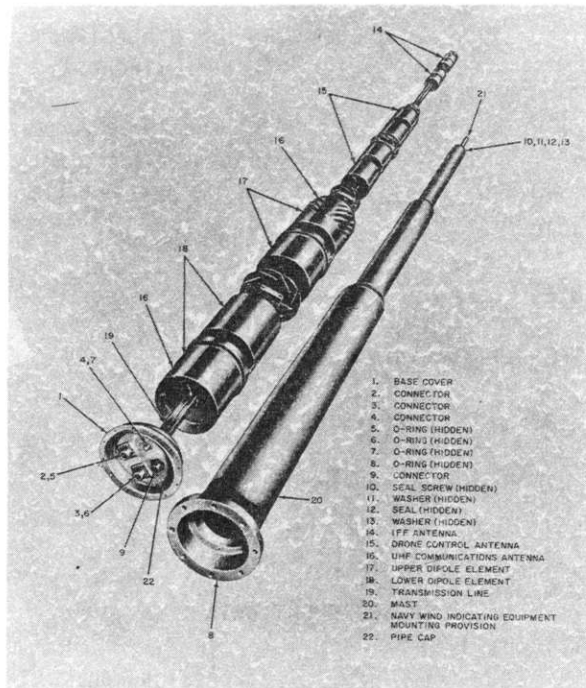

ANTENNA AS-1390/U

FUNCTIONAL DESCRIPTION:

Antenna AS-1390/U is a single vertical unit containing three separate omnidirectional antennas. This antenna assembly consists of a UHF communications antenna, identical in electromagnetic characteristics to AS-1018/URC (lower unit); a drone control operations antenna, identical in electro-magnetic characteristics to AT-948/U (middle unit); and an IFF operations antenna (upper unit). The multi-unit antenna assembly is designed to provide unobstructed and interference-free antenna operation for UHF communications, drone control operations, and IFF operations. With all three antennas in a single vertical assembly, isolation greater than 25 db between antennas is provided. The entire antenna assembly and internal transmission lines are completely enclosed in a fiberglass mast. Provision is made for mounting Navy Wind Indicating Equipment, Type B, atop the antenna assembly.

No field changes in effect at time of preparation (25 June 1965).

ANTENNA AS-1390/U

RELATION TO OTHER EQUIPMENT: None.

EQUIPMENT REQUIRED BUT NOT SUPPLIED: None.

TECHNICAL CHARACTERISTICS:

FREQUENCY RANGE

- UHF COMMUNICATION ANTENNA: 225 mc to 400 mc.
- DRONE CONTROL ANTENNA: 400 mc to 550 mc.
- IFF ANTENNA: 1000 mc to 1150 mc.

RF POWER HANDLING CAPABILITIES

- UHF COMMUNICATION ANTENNA: 2 kw average throughout range.
- DRONE CONTROL ANTENNA: 2 kw average throughout range.
- IFF ANTENNA: 1 kw average throughout range.

POLARIZATION: All three antennas are vertically polarized.

GAIN: Approx 5 db above an isotropic source for all three antennas.

INPUT IMPEDANCE: 50 ohms for all three antennas.

MAXIMUM VOLTAGE STANDING WAVE RATIO

- UHF COMMUNICATION ANTENNA: 2.0:1.0.
- DRONE CONTROL ANTENNA: 1.8:1.0.
- IFF ANTENNA: 1.8:1.0.

CIRCULARITY OF PATTERN: Horizontal radiation patterns omni-directional to within ± 1.0 db throughout all three freq ranges.

TILT OF PATTERN: The vertical lobes of all three antennas are tilted upward to place lower half power points on or below horizon.

WIND LOAD: 120 mph.

MAXIMUM PRESSURIZATION: 15 psig.

AMBIENT OPERATIONAL TEMPERATURE RANGE: -32° C to $+52^{\circ}$ C (-26° F to $+125^{\circ}$ F).

ISOLATION BETWEEN ANTENNAS: Min of 25 db.

MAJOR COMPONENTS

QTY	ITEM	DIMENSIONS (INCHES)	WEIGHT (LBS)
1	Antenna AS-1390/U includes:	14 x 14 x 166	98
2	Technical Manual NAVSHIPS 94760		

REFERENCE DATA AND LITERATURE:

NAVSHIPS 94760: Technical Manual for Antenna AS-1390/U.

TUBE, CRYSTAL AND/OR SEMI-CONDUCTOR DATA:

TUBES: Not required.

CRYSTALS: Not required.

SEMI-CONDUCTORS: Not required.

ANTENNA AS-1390/U

SHIPPING DATA

PKGS	VOLUME (CU FT)	WEIGHT (LBS)
1	32	275

PROCUREMENT DATA

PROCURING SERVICE: USN
SPEC &/OR DWG:

DESIGN COG: USN, Buships

CONTRACTOR	LOCATION	CONTRACT OR ORDER NO.	APPROX. UNIT COST
CHU Associates	Littleton, Mass.	N0bsr 87639	

6 October 1966

ANTENNA AT-121B/AP

Cog Service: USN FSN:

Functional Class:

USA

USN

USAF

TYPE CLASS:

Used by

MANUFACTURER'S NAME/CODE NUMBER: Land Air Inc.,

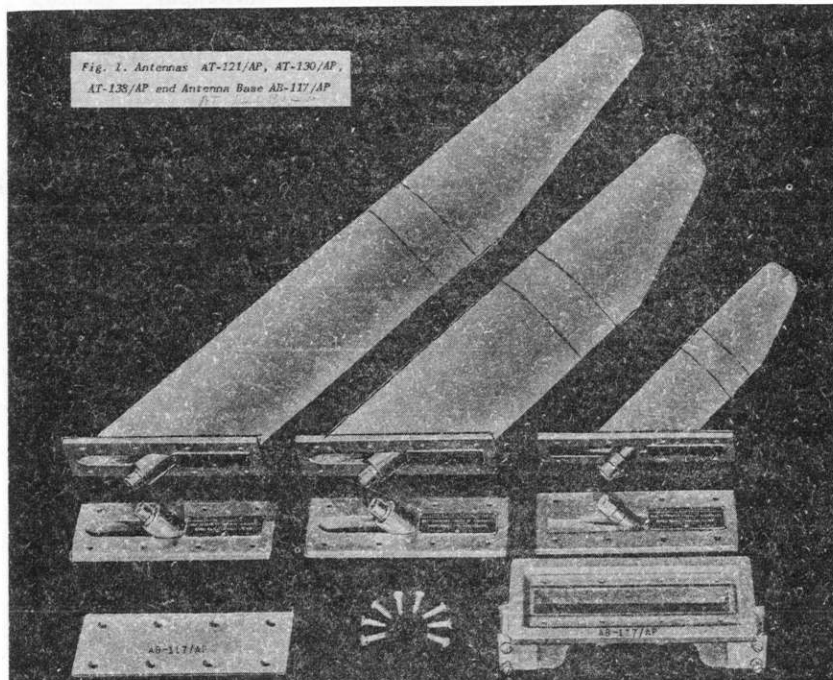

ANTENNA AT-121B/AP

FUNCTIONAL DESCRIPTION:

The Antenna AT-121B/AP is a very high and ultra-high frequency, broad-band, streamlined, blade antenna of the sleeved stub type. The intended use is for jamming or searching operations.

No field changes in effect at time of preparation (20 April 1966).

RELATION TO OTHER EQUIPMENT:

The AT-121B/AP is Electrically and mechanically interchangeable with AT-121/AP and AT-121A/AP. Differs in improved design and construction.

EQUIPMENT REQUIRED BUT NOT SUPPLIED: None.

ANTENNA AT-121B/AP

TECHNICAL CHARACTERISTICS:

FREQUENCY RANGE

TRANSMITTING: 90 to 175 mc.

RECEIVING: 80 to 300 mc.

INPUT IMPEDANCE: 50 ohms.

MAJOR COMPONENTS

QTY	ITEM	DIMENSIONS (INCHES)	WEIGHT (LBS)
1	Antenna AT-121B/AP	3-1/2 x 6-1/2 x 35-1/2	6.7

REFERENCE DATA AND LITERATURE:

NAVAER 16-35AT121-501: Instruction Sheet for Antennas AT-121/AP, AT-130/AP, AT-138/AP and Antenna Base AB-117/AP.

SHIPPING DATA

PKGS VOLUME (CU FT) WEIGHT (LBS)

PROCUREMENT DATA

PROCURING SERVICE: USN

DESIGN COG: USN, BuWeps

SPEC &/OR DWG: MIL-A-18376A (AER)

CONTRACTOR	LOCATION	CONTRACT OR ORDER NO.	APPROX. UNIT COST
Land Air Inc.	Chicago, Illinois	N383-51767A	

27 July 1964

ALARM MONITOR BZ-54/GRN

Cog Service: USN FSN:

Functional Class:

USA

USN

USAF

TYPE CLASS:

Used by

MANUFACTURER'S NAME/CODE NUMBER: Alto Scientific Co. Inc., (02194).

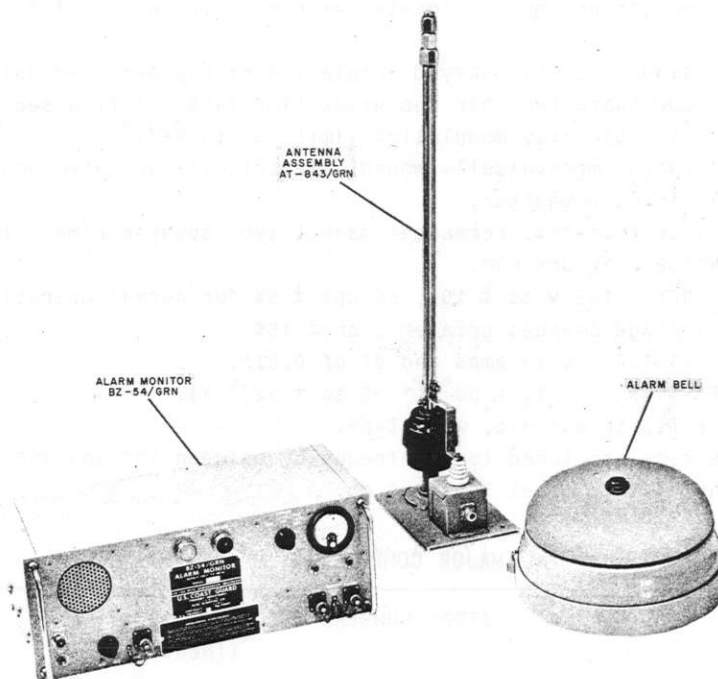

ALARM MONITOR BZ-54/GRN

FUNCTIONAL DESCRIPTION:

Alarm Monitor BZ-54/GRN is a compact, transistorized unit, designed for continuous service operation under widely temperature and humidity conditions as encountered at isolated installations ashore and afloat.

The equipment is used to monitor continuously the radio-frequency power and the modulation level of radio-beacon transmitters used as radio aids to navigation. The equipment also monitors the station power line voltage.

No field changes in effect at time of preparation (25 June 1964).

RELATION TO OTHER EQUIPMENT:

BZ-54/GRN ALARM MONITOR

EQUIPMENT REQUIRED BUT NOT SUPPLIED:

TECHNICAL CHARACTERISTICS:

FREQUENCY RANGE: 285 to 325 kc w/10% overlap at ea extreme.

SENSITIVITY: Capable of normal operation monitoring transmitter-radiated power between 0.01 and 100 W when the monitor antenna is located within 50 to 500 ft of the transmitter antenna.

TYPE OF RECEPTION: Continuous carrier-keyed modulation or keyed-tone-modulated carrier, keying at 30 morse code characters per sec w/max time lapse of five sec between characters; modulation 400 to 1050 cps, modulation limits 30 to 95%.

ALARM BELL: Spring operated, mechanically wound, electrically actuated and capable of being heard up to 1/8 mile in calm weather.

OUTPUT SIGNAL: 20 mw into four-ohm, permanent magnet type speaker w/max distortion of 12%.

INPUT IMPEDANCE TO MONITOR: 50 ohm nom.

LINE VOLTAGE AND FREQUENCY: 115 v ac $\pm 10\%$, 60 cps $\pm 5\%$ for normal operation and failure induction for line voltage changes greater than $\pm 15\%$.

LINE CURRENT AND POWER FACTOR: 0.23 amps and pf of 0.815.

AMBIENT OPERATING TEMPERATURE: 0 to $+ 50^{\circ}$ ($+ 32$ to $+ 122^{\circ}$ F).

ANTENNA: At-843/GRN, 6 ft, telescopic, whip type.

SELECTIVITY: With the receiver tuned to any frequency between 285 and 385 kc, attenuation of signals at 200 and 425 kc is at least 40 db.

MAJOR COMPONENTS

QTY	ITEM	STOCK NUMBERS	DIMENSIONS (INCHES)	WEIGHT (LBS)
1	Alarm Monitor BZ-54/GRN includes:		7 x 11 x 24	28.5
1	Alarm Bell		6-3/8 x 11-7/16 x 11-7/16	16.5
1	Antenna Assy AT-843/GRN		6 x 8 x 78	9.5
2	Technical Manuals		1/2 x 8-1/2 x 11	0.5
1	Test Records			
1	Equipment Spares		7-3/4 x 17-3/4 x 21	25

REFERENCE DATA AND LITERATURE:

CG-273-60: Technical Manual for Alarm-Monitor BZ-54/GRN.

TUBE, CRYSTAL AND/OR SEMI-CONDUCTOR DATA:

TUBES: Not required.

CRYSTALS: Not required.

SEMI-CONDUCTORS: (4) 2N128 (7) 2N43A (1) 2N327A (2) 2N241A (3) 2N158 (2) 2N490

1.2 BZ-54/GRN: 2

SEMI-CONDUCTORS: (1) 1N1771 (5) 1N270 (4) 1N538 (3) 1N1317A (1) 1N1314A
 (1) 1N1774 (1) 652C5 (1) 1N1880

SHIPPING DATA

PKGS	VOLUME (CU FT)	WEIGHT (LBS)
1	7.4	150

PROCUREMENT DATA

PROCURING SERVICE: USN
 SPEC &/OR DWG:

DESIGN COG: USN, USCG

CONTRACTOR	LOCATION	CONTRACT OR ORDER NO.	APPROX. UNIT COST
Alto Scientific Co. Inc.	Palo Alto, California	TCG 40654	



1 August 1967

ALARM-MONITOR BZ-70A/GRN

Cog Service: USN FSN:

Functional Class:

USA

USN

USAF

TYPE CLASS:

Used by

MANUFACTURER'S NAME/CODE NUMBER: Inland Electronics Corp., (02572).

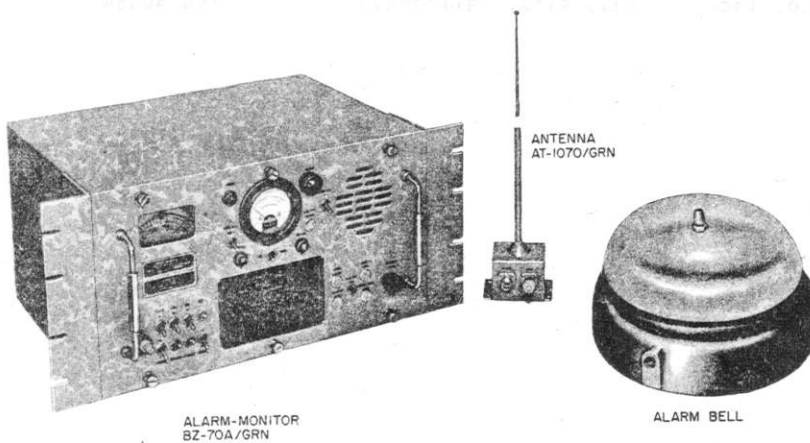

ALARM-MONITOR
BZ-70A/GRN

ALARM BELL

ALARM-MONITOR BZ-70A/GRN

FUNCTIONAL DESCRIPTION:

The Alarm Monitor BZ-70A/GRN is a crystal controlled superheterodyne AM radio receiver which operates with the antenna to receive radiobeacon signals.

No field changes in effect at time of preparation (4 July 1966).

RELATION TO OTHER EQUIPMENT:

The BZ-70A/GRN is two-way interchangeable with BZ-70/GRN except for the change in value of two component parts.

EQUIPMENT REQUIRED BUT NOT SUPPLIED:

- (2) Cable, Electrical: Navy DHFA-3;
- (2) Crystal Units: CR-25/U;
- (1) Cable, Radio Frequency: RG-8/U;

1.2 BZ-70A/GRN: 1

- (2) Connector, Electrical: UG-21D/U;
 (1) Master Clock: CYG-25, MT-188.

TECHNICAL CHARACTERISTICS:

FREQUENCY RANGE: 285 kc to 325 kc.

TYPE OF FREQUENCY CONTROL: Crystal controlled.

TYPE OF RECEPTION: AM reception.

RECEIVER OUTPUT: The audio output of the alarm monitor is 500 mw into a 4 ohm, T-pad volume control and permanent magnet speaker.

- (1) Input Impedance: 50 ohms.
 (2) Output Impedance: 4 ohms.

CRYSTAL DATA: (Crystals not furnished.)

- (1) Two Required: Local Oscillator and Calibration oscillator.
 (2) CR-25/U: Government type designation.
 (3) Frequency: Frequency of local oscillator crystal is the desired receiver frequency plus 175 kc; frequency of calibration oscillator is same as received signal.
 (4) Temperature Coefficient: 1.
 (5) Operating Temperature Range: -40 deg C (-40 deg F) to +70 deg C (+158 deg F).
 (6) Accuracy Over Operating Range: 0.01 percent.

RECEIVER SENSITIVITY AND STABILITY DATA: Input signals of 20 microvolts to 5 volts; Image rejection is 60 decibels minimum; Audio output distortion is 12 percent maximum at 500 mw output.

POWER SOURCE REQUIRED: 115 v ac, 60 cyc, single ph.

POWER CONSUMPTION: 65 watts at a 0.85 power factor.

AMBIENT TEMPERATURE RANGE: The operating ambient temperature range of this equipment is 0 deg C (+32 deg F) to +50 deg C (+122 deg F).

BANDWIDTH CHARACTERISTICS: Bandwidth 3 to 5 kc at 6 db down; 4 to 6 kc at 10 db down.

MAJOR COMPONENTS

QTY	ITEM	DIMENSIONS (INCHES)	WEIGHT (LBS)
1	Alarm Monitor BZ-70A/GRN w/Brackets includes:	10-1/2 x 16-1/2 x 24	47
1	Antenna Kit: AT-1070/GRN	4 x 4 x 72-1/2	2
1	Alarm Bell	11-7/16 dia x 6-3/8	16-1/2
1	Maintenance Parts Kit	12-1/2 x 14 x 15	30
1	Test Record		
2	Technical Manuals	3/8 x 8-3/4 x 11-1/4	1
1	Installation Drawing		
2	Servicing Diagrams	1/16 x 11 x 15	3/8

REFERENCE DATA AND LITERATURE:

CG-273-88: Technical Manual for Alarm Monitor BZ-70A/GRN.

26 August 1965

CONTROL, ANTENNA C-1670A/U

Cog Service: USN FSN:

Functional Class:

USA

USN

USAF

TYPE CLASS:

Used by

MANUFACTURER'S NAME/CODE NUMBER: American Electronic Laboratories Inc., (93346).

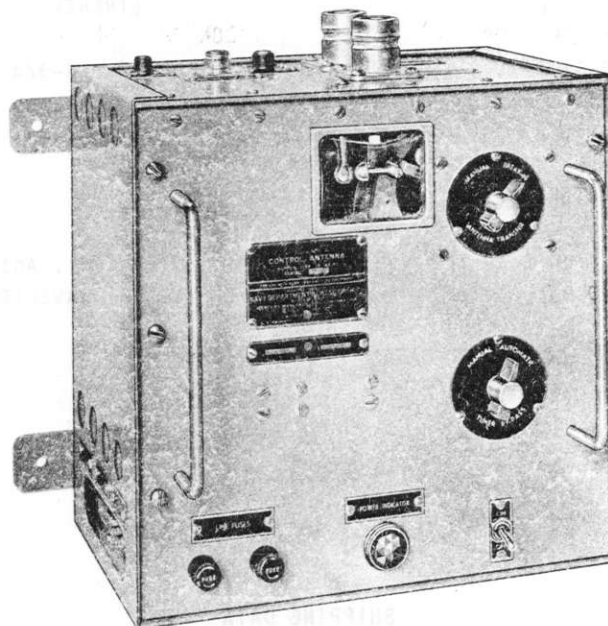

CONTROL, ANTENNA C-1670A/U

FUNCTIONAL DESCRIPTION:

Control, Antenna C-1670A/U is designed to provide an automatic antenna transfer and keying system for break-in operation, replacing the manual means now employed in Navy Model TBL Series Radio Transmitting Equipments. The unit is interconnected with the keying circuit of the transmitter in such manner that the antenna transfer contacts are never required to break the antenna current. This is accomplished by adjusting the keying circuits contacts in such relation to the antenna transfer contacts that the latter close before and open after the keying contacts. In addition, the unit connects the receiver to the antenna when the key is open and grounds the receiver when the key is closed, thus making break-in operation possible.

No field changes in effect at time of preparation (13 August 1965).

RELATION TO OTHER EQUIPMENT:

C-1670A/U is electrically and mechanically interchangeable with the C-1670/U, but maintenance parts differ.

747

CONTROL, ANTENNA C-1670A/U

EQUIPMENT REQUIRED BUT NOT SUPPLIED: None.

TECHNICAL CHARACTERISTICS:

OPERATING FREQUENCY RANGE: 2 to 20 mc.
KEYING SPEED: 60 wpm.
CIRCUIT CLOSING DELAY: Adjustable from 0 to 1 sec.
POWER REQUIREMENTS: 115 v, 60 cps, 1 ph.

MAJOR COMPONENTS

QTY	ITEM	DIMENSIONS (INCHES)	WEIGHT (LBS)
1	Control, Antenna C-1670A/U includes:	10 x 13-3/4 x 15-1/4	39
1	Set of Accessories	2 x 4-1/2 x 4-3/4	3.3

REFERENCE DATA AND LITERATURE:

NAVSHIPS 92566: Instruction Book for Navy Type C-1670/U Control, Antenna.
CHANGE (1): To technical Manual for Antenna Control C-1670/U NAVSHIPS 92566.

TUBE, CRYSTAL AND/OR SEMI-CONDUCTOR DATA:

TUBES: Not required.

CRYSTALS: Not required.

SEMI-CONDUCTORS: Not required.

SHIPPING DATA

PKGS	VOLUME (CU FT)	WEIGHT (LBS)
------	----------------	--------------

PROCUREMENT DATA

PROCURING SERVICE: USN
SPEC &/OR DWG:

DESIGN COG: USN, BuShips

CONTRACTOR	LOCATION	CONTRACT OR ORDER NO.	APPROX. UNIT COST
American Electronic Labora- tories Inc.	Colmar, Pennsylvania	NObsr 85174	\$813.00

27 July 1964

Cog Service: USN FSN:

CONTROL, CONSTANT FREQUENCY C-2249/U

Functional Class:

USA

USN

USAF

TYPE CLASS:

Used by

MANUFACTURER'S NAME/CODE NUMBER: Consolidated Avionics Corp., (02376).

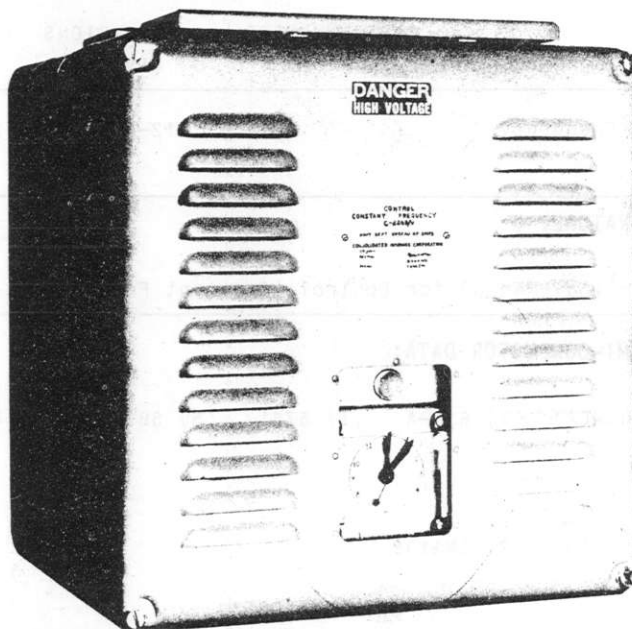

CONTROL, CONSTANT FREQUENCY C-2249/U

FUNCTIONAL DESCRIPTION:

Control, Constant Frequency C-2249/U is designed to supply 60 cycles, controlled-frequency ac power for operation of synchronous devices aboard ship. This system is completely electronic and uses no rotating parts.

No field changes in effect at time of preparation (1 July 1964).

RELATION TO OTHER EQUIPMENT:

EQUIPMENT REQUIRED BUT NOT SUPPLIED:

C-2249/U CONTROL, CONSTANT FREQUENCY

TECHNICAL CHARACTERISTICS:

INPUT: 108 to 122 v, 55 to 65 cyc, single ph, 4.0 amp.

OUTPUT: 120 v \pm 7.5%, 60 cyc \pm 0.01%, single ph.

CAPACITY: 100 W at 0.95 pf lagging, continuous duty.

HEAT DISSIPATION: 500 W approx.

MOUNTING: Bulkhead, 3-point.

MAJOR COMPONENTS

QTY	ITEM	STOCK NUMBERS	DIMENSIONS (INCHES)	WEIGHT (LBS)
1	Control, Constant Frequency C-2249/U		12-3/16 x 14 x 14-7/8	77.5

REFERENCE DATA AND LITERATURE:

NAVSHIPS 365-2483: Technical Manual for Control, Constant Frequency C-2249/U.

TUBE, CRYSTAL AND/OR SEMI-CONDUCTOR DATA:

TUBES: (1) 0A2 (1) 5R4WGA (2) 811-A (1) 5751 (5) 5814 (2) 6005/6A05W

CRYSTALS: None used.

SEMI-CONDUCTORS: (4) 1N1130 (2) 1N1131

SHIPPING DATA

PKGS	VOLUME (CU FT)	WEIGHT (LBS)
------	----------------	--------------

PROCUREMENT DATA

PROCURING SERVICE: USN

DESIGN COG: USN, BuShips

SPEC &/OR DWG:

CONTRACTOR	LOCATION	CONTRACT OR ORDER NO.	APPROX. UNIT COST
Consolidated Avionics Corporation	Westbury, New York	N0bs-67964 N0bs-68301	

18 July 1967

Cog Service: IISN FSN:

CONTROL, RADIO SET C-2383/URC-9
Functional Class:

USA

USN

USAF

TYPE CLASS:

Used by

MANUFACTURER'S NAME/CODE NUMBER: Teledyne Systems Co., Dubrow Electronics Div., (89114).

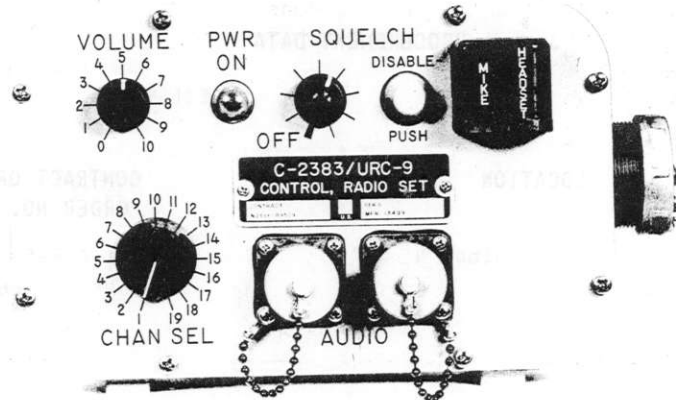

CONTROL, RADIO SET C-2383/URC-9

FUNCTIONAL DESCRIPTION:

Control, Radio Set C-2383/URC-9 provides for the operation of Radio Set AN/URC-9 from a remote position. When it is connected to Radio Set AN/URC-9 or AN/URC-9X the following functions may be performed: push-to-talk, side tone, and the receiving of audio signals from the radio set. It has a channel selector for 19 preset channels available on the radio set. It has a control for receiver squelch and a volume control for received audio signals.

No field changes in effect at time of preparation (17 February 1967).

RELATION TO OTHER EQUIPMENT: None

EQUIPMENT REQUIRED BUT NOT SUPPLIED: None

TECHNICAL CHARACTERISTICS:

CONTROLS: Channel Selector (for 19 preset channels), volume control, receiver squelch.

CONTROL, RADIO SET C-2383/URC-9

control, push-to-talk.

INSTALLATION: In vehicles; landing craft; wall mounted aboard ships.

REMOTE DISTANCE: Within radius of 100. ft from the radio set.

MAJOR COMPONENTS

QTY	ITEM	DIMENSIONS (INCHES)	WEIGHT (LBS)
1	Control, Radio Set, C-2383/URC-9		

REFERENCE DATA AND LITERATURE:

Preliminary Instruction Book for Control, Radio Set C-2383/URC-9.

SHIPPING DATA

PKGS	VOLUME (CU FT)	WEIGHT (LBS)
1	1.5	6

PROCUREMENT DATA

PROCURING SERVICE: USN
SPEC &/OR DWG:

DESIGN COG: USN, NavShips

CONTRACTOR	LOCATION	CONTRACT OR ORDER NO.	APPROX. UNIT COST
Teledyne Systems Co., Dubrow Electronics Div.	Burlington, N. J.	NObsr-89509 NObsr-63366	

2 August 1967

CONTROL ELECTRICAL FREQUENCY C-2749A/URT

Cog Service: USN

FSN:

Functional Class:

USA

USN

USAF

TYPE CLASS:

Used by

MANUFACTURER'S NAME/CODE NUMBER: The Technical Material Corporation, (82679).

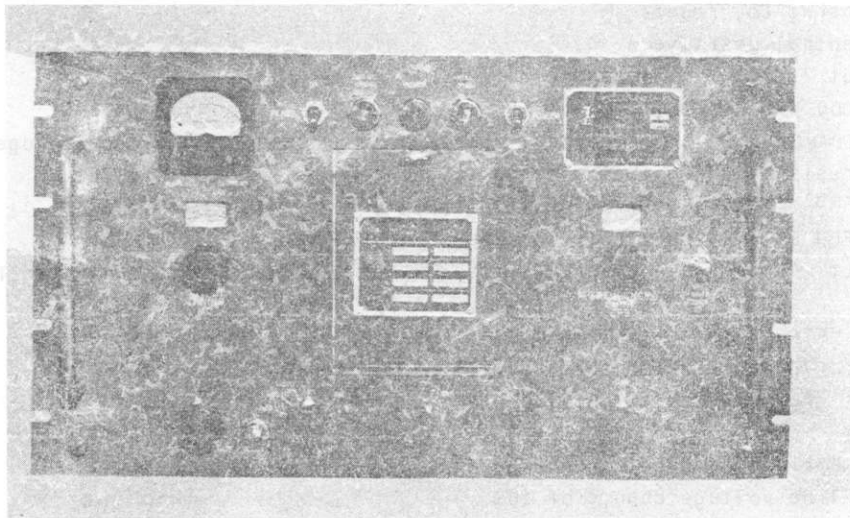

CONTROL ELECTRICAL FREQUENCY C-2749A/URT

FUNCTIONAL DESCRIPTION:

The Control Electrical Frequency C-2749A/URT is a single unit, frequency shift exciter designed for fixed station use, is a high stability RF oscillator which provides a means of shifting an RF carrier in accordance with the variations of an audio pulse signal. It provides frequency shift telegraph signals in two bands, 1 to 2.5 mc and 2.5 to 6.9 mc. The equipment replaces the crystal oscillator in a GPT-10K and provides "mark and space" carrier shift transmission of teleprinter, telegraph, and facsimile (or telephoto) intelligence. Carrier shift up to 1000 cycles is available; either linear with applied voltage or independent of applied voltage-amplitude variations.

No field changes in effect at time of preparation (7 April 1966).

RELATION TO OTHER EQUIPMENT:

The C-2749A/URT is Mechanically and Electrically interchangeable with C-2749/URT except

1.2 C-2749A/URT: 1

CONTROL ELECTRICAL FREQUENCY C-2749A/URT

improved model with changed switch and maintenance parts differ.

EQUIPMENT REQUIRED BUT NOT SUPPLIED:

- (3) Crystals: CR-27/U, (2 to 4 mc);
- (1) Power Supply Line.

TECHNICAL CHARACTERISTICS:

OUTPUT FREQUENCY RANGE: 1 to 2.5 mc on band 1; 2.5 to 6.9 mc on band 2.

FREQUENCY SHIFT: Linear to 1000 cycles.

OUTPUT POWER: Adjustable to 3 watts.

OUTPUT IMPEDANCE: 50 to 70 ohms.

KEYING SOURCES:

- (a) Contact closing to ground.
- (b) Polar or neutral positive.
- (c) Linear input 30,000 ohms impedance.

KEYING SPEED: 1000 WPM maximum.

KEYING INPUT IMPEDANCE: Polar or neutral operation 1,000,000 ohms may be bridged by external 1800 ohm loop resistance; Contact closing to ground must be open circuit.

RF SOURCE: Internal crystal oscillator or external oscillator.

INPUT-IMPEDANCE FOR EXTERNAL SOURCE: 70 ohms, 6 to 8 VRMS.

FREQUENCY CONTROL: High-frequency crystal oscillator 0.8 to 6.7 mc; High stability 200 kc oscillator.

CRYSTAL HOLDERS: FT-243 three positions and HC-6/U three positions.

OVEN TEMPERATURE: 70 deg C held constant within ± 0.1 deg C.

KEYING BIAS: Not greater than 10% at 1000 WPM.

OVERALL STABILITY

- (a) 10 cps for ambient temperature change of 0 deg C to 50 deg C.
- (b) 10 cps for line voltage change of 10%.
- (c) No drift for input signal variations of +25 volts to +150 volts (mark frequency).

METERING: PA-plate current (tuning).

CRYSTAL FREQUENCY: Assigned transmitter frequency minus 200 kc transmitter multiplication.

MONITORING: 100 mv across 70 ohm coaxial connector.

POWER REQUIREMENTS: 115 to 230 volts ac, 50 to 60 cycles single ph, both ovens off-100 watts; each oven-40 watts.

FREQUENCY RANGE: 1 to 6.9 mcs at 1,000 cycles.

MOUNTING: Standard Relay Rack.

MAJOR COMPONENTS

QTY	ITEM	DIMENSIONS (INCHES)	WEIGHT (LBS)
1	Control, Electrical Frequency C-2749A/URT includes:	10-1/2 x 16 x 19	48-1/2
1	Cable Assembly: CA-103	72	1/2

REFERENCE DATA AND LITERATURE:

NAVSHIPS 93166: Technical Manual for Transmitting Set, Radio, Model GPT-10K, AN/FRT-39 and 39A.

SHIPPING DATA

PKGS	VOLUME (CU FT)	WEIGHT (LBS)
1	4.4	91

PROCUREMENT DATA

PROCURING SERVICE: USN
 SPEC &/OR DWG:

DESIGN COG: USN, BuShips

CONTRACTOR	LOCATION	CONTRACT OR ORDER NO.	APPROX. UNIT COST
The Technical Material Corp. Model XFK-2	Mamaroneck, N.Y.	NObsr-81106 NObsr-81394	

755

12 August 1965

CONTROL, MOTOR-GENERATOR C-3414/USQ-20(V) TYPE 1183

Cog Service: USN

FSN:

Functional Class:

USA

USN

USAF

TYPE CLASS:

Used by

MANUFACTURER'S NAME/CODE NUMBER: Univac Div. of Sperry Rand Corp., (90536).

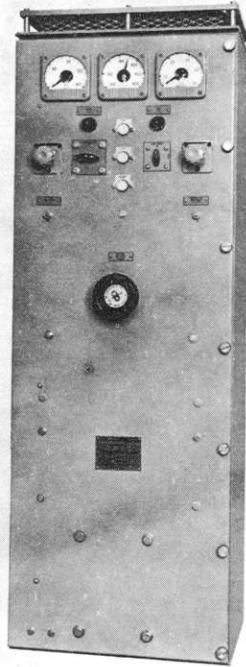

CONTROL, MOTOR-GENERATOR C-3414/USQ-20(V) TYPE 1183

FUNCTIONAL DESCRIPTION:

Control, Motor-Generator C-3414/USQ-20(V) Type 1183 provides ac motor control, voltage regulation and recovery, short circuit characteristics, and automatic and manual voltage adjustment control. The controller may be used to control either the PU-491/USQ-20(V) or PU-492/USQ-20(V) motor generator. This equipment is part of the Navy Tactical Data System.

No field changes in effect at time of preparation (28 June 1965).

RELATION TO OTHER EQUIPMENT:

The C-3414/USQ-20(V) Type 1183 and the C-3414/USQ-20(V) Type 1183.70 are interchangeable. The only difference is in the physical placement of the components. The Type 1183 and 1183.70 are manufactured by Regulators Inc.

1.2 C-3414/USQ-20(V) Type 1183: 1

CONTROL, MOTOR-GENERATOR C-3414/USQ-20(V) TYPE 1183

EQUIPMENT REQUIRED BUT NOT SUPPLIED: None.

TECHNICAL CHARACTERISTICS:

POWER REQUIREMENTS: 440 v, 60 cps, 3 ph regulated, 600 W.

COOLING REQUIREMENTS: Cooled by ambient air at 50° C (122° F) or less.

INSTALLATION REQUIREMENTS: The controller should be mtd vertically on a bulkhead within 75 ft of the motor-generator which it controls. It must have a clearance of 15-7/8 in. in front to enable opening the door.

MAJOR COMPONENTS

QTY	ITEM	STOCK NUMBERS	DIMENSIONS (INCHES)	WEIGHT (LBS)
1	Control, Motor-Generator C-3414/USQ-20(V) Type 1183 includes:		16-3/4 x 19-1/2 x 58-1/2	406
1	Technical Manual NAVSHIPS 94083			

REFERENCE DATA AND LITERATURE:

NAVSHIPS 94083: Type II Technical Manual for Motor-Generator PU-491/USQ-20(V) and PU-492/USQ-20(V) with Motor-Generator Control, C-3414/USQ-20(V) (Types 1183 and 1183.70).

TUBE, CRYSTAL AND/OR SEMI-CONDUCTOR DATA:

TUBES: Not required.

CRYSTALS: Not required.

SEMI-CONDUCTORS: (27) 1N1202 (1) 1N2041 (6) 1N253 (1) 1N429 (10) 1N255

SHIPPING DATA

PKGS	VOLUME (CU FT)	WEIGHT (LBS)
1	11.06	406

PROCUREMENT DATA

PROCURING SERVICE: USN
SPEC &/OR DWG: DS 4511

DESIGN COG: USN, BuShips

CONTRACTOR	LOCATION	CONTRACT OR ORDER NO.	APPROX. UNIT COST
Univac Div. of Sperry Rand Corporation, Pt No. V911919	St. Paul, Minnesota	NObsr 75750 NObsr 87204 NObsr 91306	

2 August 1965

CONTROL, MOTOR-GENERATOR C-3414/USQ-20(V)TYPE 1183.70

Cog Service: USN

FSN:

Functional Class:

USA

USN

USAF

TYPE CLASS:

Used by

MANUFACTURER'S NAME/CODE NUMBER: Univac Div. of Sperry Rand Corp., (90536).

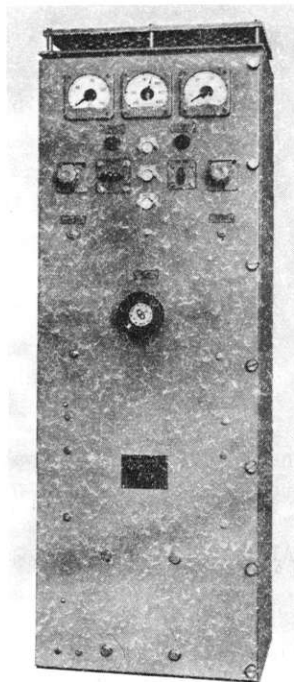

CONTROL, MOTOR-GENERATOR C-3414/USQ-20(V)TYPE 1183.70

FUNCTIONAL DESCRIPTION:

Control, Motor-Generator, C-3414/USQ-20(V)Type 1183.70 provides ac motor control, voltage regulation and recovery, short circuit characteristics, and automatic and manual voltage adjustment control. The controller may be used to control either the PU-491/USQ-20(V) or PU-492/USQ-20(V) motor generator. This equipment is part of the Navy Tactical Data System.

No field changes in effect at time of preparation (28 June 1965).

RELATION TO OTHER EQUIPMENT:

The C-3414/USQ-20(V)Type 1183.70 and the C-3414/USQ-20(V) Type 1183 are interchangeable. The only difference is in the physical placement of the components. The Type 1183.70 and the 1183 are manufactured by Regulators Inc.

758

CONTROL, MOTOR-GENERATOR C-3414/USQ-20(V) TYPE 1183.70

EQUIPMENT REQUIRED BUT NOT SUPPLIED: None.

TECHNICAL CHARACTERISTICS:

POWER REQUIREMENTS: 440 v, 60 cps, 3 ph regulated, 600 W.

COOLING REQUIREMENTS: Cooled by ambient air at 50° C (122° F) or less.

INSTALLATION REQUIREMENTS: The controller should be mtd vertically on a bulkhead within 75 ft of the motor-generator which it controls. It must have a clearance of 15-7/8 in. in front to enable opening the door.

MAJOR COMPONENTS

QTY	ITEM	STOCK NUMBERS	DIMENSIONS (INCHES)	WEIGHT (LBS)
1	Control, Motor-Generator C-3414/USQ-20(V) Type 1183.70 includes:		16-3/4 x 19-1/2 x 58-1/2	406
1	Technical Manual NAVSHIPS 94083			

REFERENCE DATA AND LITERATURE:

NAVSHIPS 94083: Type II Technical Manual for Motor-Generator PU-491/USQ-20(V) and PU-492/USQ-20(V) with Motor-Generator Control, C-3414/USQ-20(V) (Types 1183 and 1183.70).

TUBE, CRYSTAL AND/OR SEMI-CONDUCTOR DATA:

TUBES: Not required.

CRYSTALS: Not required.

SEMI-CONDUCTORS: (27) 1N1202 (1) 1N2041 (6) 1N429 (10) 1N255

SHIPPING DATA

PKGS	VOLUME (CU FT)	WEIGHT (LBS)
1	11.06	406

PROCUREMENT DATA

PROCURING SERVICE: USN
SPEC &/OR DWG:

DESIGN COG: USN, BuShips

CONTRACTOR	LOCATION	CONTRACT OR ORDER NO.	APPROX. UNIT COST
Univac Div. of Sperry Rand Corp.	St. Paul, Minn.	NObsr 75750 NObsr 87204 NObsr 91306	

759

2 August 1965

CONTROL INTRODUCER COMPUTER SET C-3674A/USQ-20(V)

Cog Service: USN FSN:

Functional Class:

USA

USN

USAF

TYPE CLASS:

Used by

MANUFACTURER'S NAME/CODE NUMBER: Univac Div. of Sperry Rand Corp., (90536).

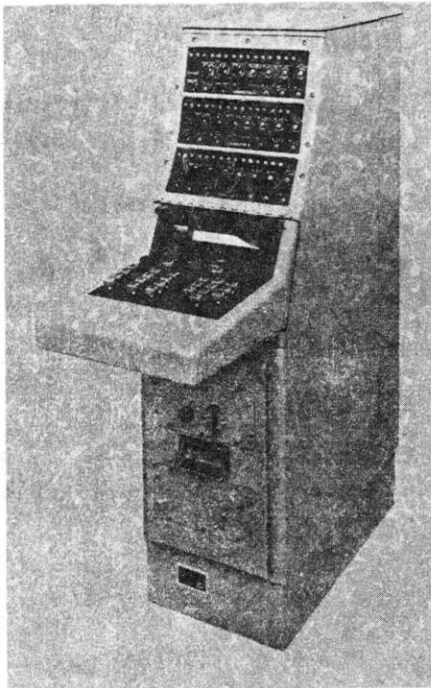

CONTROL INTRODUCER COMPUTER SET C-3674A/USQ-20(V)

FUNCTIONAL DESCRIPTION:

Control Introducer Computer Set C-3674A/USQ-20(V) is a self-contained computer control and monitoring device. It provides a means of controlling and monitoring the more significant operations for each of the computers in a particular data processing system. This system may consist of as many as three computers. Computer operations which can be performed by the control introducer include Remote Computer Operations, Computer Function Commands, and Fault and Computer Indications. This unit is used with the CP-642 or CP-642A/USQ-20(V) Digital Computer.

No field changes in effect at time of preparation (24 June 1965).

RELATION TO OTHER EQUIPMENT:

The C-3674A/USQ-20(V) is similar to C-3674/USQ-20(V) introducer for three computer operations. The differences between the units are mechanical. Electrically they are identical. If

CONTROL INTRODUCER COMPUTER SET C-3674A/USQ-20(V)

two computers operations are required, either C-3675 or C-3675A/USQ-20(V) may be used as a replacement.

EQUIPMENT REQUIRED BUT NOT SUPPLIED:

(1) Electronic Circuit Plug-in Unit Test Set AN/USM-142(V); (2) Technical Manual NAVSHIPS 94087; (1) Multimeter AN/PSM-4C; (1) Oscilloscope AN/USM-105A w/Dual Trace Plug-in Preamplifier MX-2930A/USM-105; (1) Transistor Tester TS-1100A/U; (1) Tool Set AN/USM-3; (1) Hand Stripper Ideal Inds 45-171; (1) Hand Crimper CAWG-47043; (1) Hand Insertion Tool CAWG-380310-3.

TECHNICAL CHARACTERISTICS:

INPUT POWER: 115 v ac \pm 10%, 400 cyc \pm 5%, 3 ph, 200 W.

INPUT-OUTPUT SIGNAL

COMPUTER TO SYSTEM MONITORING PANEL

FORMAT 15 BITS PARALLEL

DATA LINES

LOGICAL 1: 0 v dc \pm 1.5 v.

LOGICAL 0: - 13.5 v dc + 3.5 v - 4.0 v.

CONTROL LINES

LOGICAL 1: 0 v dc \pm 1.5 v.

LOGICAL 0: - 13.5 v dc + 3.5 v - 4.0 v.

SYSTEM MONITORING PANEL TO COMPUTER

FORMAT 30 BITS PARALLEL

DATA LINES

LOGICAL 1: 0 v dc \pm 1.5 v.

LOGICAL 0: - 14 v dc \pm 2 v.

CONTROL LINES

LOGICAL 1: 0 v dc \pm 1.5 v.

LOGICAL 0: - 13.5 v dc + 3.5 v - 4.0 v.

TYPE COOLING: Forced air - 120 CFM.

MAJOR COMPONENTS

QTY	ITEM	STOCK NUMBERS	DIMENSIONS (INCHES)	WEIGHT (LBS)
1	Control Introducer Computer Set C-3674A/USQ-20(V) includes:		13 x 45-27/32 x 49-1/2	400
1	Power Chassis		10-3/4 x 22-1/4 x 26-7/8	
2	Technical Manual NAVSHIPS 94089			

REFERENCE DATA AND LITERATURE:

NAVSHIPS 94089(A): Technical Manual for Computer Set Control Introducers C-3674/USQ-20(V), C-3674A/USQ-20(V), C-3675/USQ-20(V) and C-3675A/USQ-20(V).

CONTROL INTRODUCER COMPUTER SET C-3674A/USQ-20(V)

TUBE, CRYSTAL AND/OR SEMI-CONDUCTOR DATA:

TUBES: Not required.

CRYSTALS: Not required.

SEMI-CONDUCTORS: (45) GDG1248 (1) 1N969B (12) 1N3033B (66) SM189 (1) 1N2818RB
(3) 2N1729 (1) 1N2808RB (1) 2N539 (263) 1N3097 (1) 2N1358
(122) 1N3669 (151) SM15 (75) 538 (10) GA322 (1) 1N2818B
(1) 2N328A (1) 1N2972B (1) 3N45 (440) 1N3592 (45) 34317
(3) 1N758A (10) GA323 (38) 1N202 (1) 2N657 (1) 1N280RB (1) 2N539

SHIPPING DATA

PKGS	VOLUME (CU FT)	WEIGHT (LBS)
1	31.4	500

PROCUREMENT DATA

PROCURING SERVICE: USN
SPEC &/OR DWG:

DESIGN COG: USN, BuShips

CONTRACTOR	LOCATION	CONTRACT OR ORDER NO.	APPROX. UNIT COST
Univac Div., of Sperry Rand Corp.	St. Paul, Minn.	NObsr-87204 NObsr-89383-2 NObsr-91306 NObsr-91369	

762

2 August 1965

CONTROL INTRODUCER, COMPUTER SET C-3675A/USQ-20(V)

Cog Service: USN FSN:

Functional Class:

USA

USM

USAF

TYPE CLASS:

Used by

MANUFACTURER'S NAME/CODE NUMBER: Univac Div. of Sperry Rand Corp., (90536).

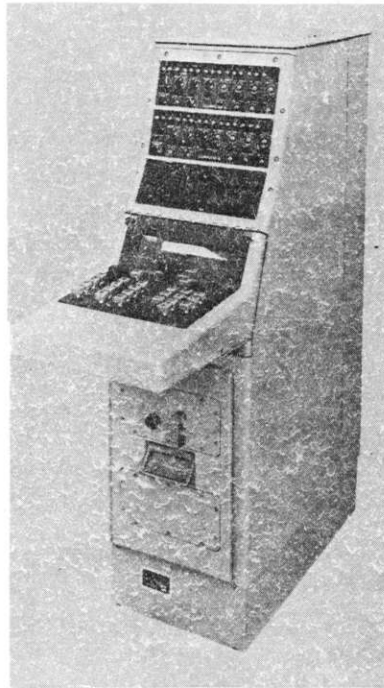

CONTROL INTRODUCER, COMPUTER SET C-3675A/USQ-20(V)

FUNCTIONAL DESCRIPTION:

Control Introducer Computer Set C-3675A/USQ-20(V) is a self-contained computer control and monitoring device. It provides a means of controlling and monitoring the more significant operations for each of the computers in a particular data processing system. This system may consist of as many as two computers. Computer operations which can be performed by the control introducer include Remote Computer Operations, Computer Function Commands, and Fault and Computer Indications. This equipment is used with the CP-642 or CP-642A/USQ-20(V) Digital Data Computer.

No field changes in effect at time of preparation (24 June 1965).

RELATION TO OTHER EQUIPMENT:

The C-3675A/USQ-20(V) is similar to C-3675/USQ-20(V), C-3674/USQ-20(V) and C-3674A/USQ-20(V).

CONTROL INTRODUCER, COMPUTER SET C-3675A/USQ-20(V)

The differences between the units are mechanical. Electrically they are identical. The C-3675 and C-3675A/USQ-20(V) control two computers each whereas the C-3674 and C-3674A/USQ-20(V) controls three computers each.

EQUIPMENT REQUIRED BUT NOT SUPPLIED:

(1) Electronic Circuit Plug-in Unit Test Set AN/USM-142(V); (2) Technical Manual NAVSHIPS 94087; (1) Multimeter AN/PSM-4C; (1) Oscilloscope AN/USM-105A w/Dual Trace Plug-in Preamplifier MX-2930A/USM-105; (1) Transistor Tester TS-1100A/U; (1) Tool Set AN/USM-3; (1) Hand Stripper Ideal Inds 45-171; (1) Hand Crimper CAWG-47043; (1) Hand Insertion Tool CAWG-380310-3.

TECHNICAL CHARACTERISTICS:

INPUT POWER: 115 v ac \pm 10%, 400 cyc \pm 5%, 3 ph, 220 W.

INPUT-OUTPUT SIGNAL

COMPUTER TO SYSTEM MONITORING PANEL

FORMAT 15 BITS PARALLEL

DATA LINES

LOGICAL 1: 0 v dc \pm 1.5 v.

LOGICAL 0: - 13.5 v dc + 3.5 v - 4.0 v.

CONTROL LINES

LOGICAL 1: 0 v dc \pm 1.5 v.

LOGICAL 0: - 13.5 v dc + 3.5 v - 4.0 v.

SYSTEM MONITORING PANEL TO COMPUTER

FORMAT 30 BITS PARALLEL

DATA LINES

LOGICAL 1: 0 v dc \pm 1.5 v.

LOGICAL 0: - 14 v dc \pm 2 v.

CONTROL LINES

LOGICAL 1: 0 v dc \pm 1.5 v.

LOGICAL 0: - 13.5 v dc + 3.5 v - 4.0 v.

TYPE OF COOLING: Forced air - 120 CFM.

MAJOR COMPONENTS

QTY	ITEM	STOCK NUMBERS	DIMENSIONS (INCHES)	WEIGHT (LBS)
1	Control Introducer Computer Set C-3675A/USQ-20(V) includes:		13 x 45-27/32 x 49-1/2	400
1	Power Chassis		10-3/4 x 22-1/4 x 26-7/8	
2	Technical Manual NAVSHIPS 94089			

REFERENCE DATA AND LITERATURE:

NAVSHIPS 94089(A): Technical Manual for Computer Set Control Introducers C-3674/USQ-20(V), C-3674A/USQ-20(V), C-3675/USQ-20(V) and C-3675A/USQ-20(V).

27 July 1964

Cog Service: USN FSN:

CONTROL, RECORDER-REPRODUCER C-3766/WIH
Functional Class:

USA

USN

USAF

TYPE CLASS:

Used by

MANUFACTURER'S NAME/CODE NUMBER: Dynalec Corporation, (12763).

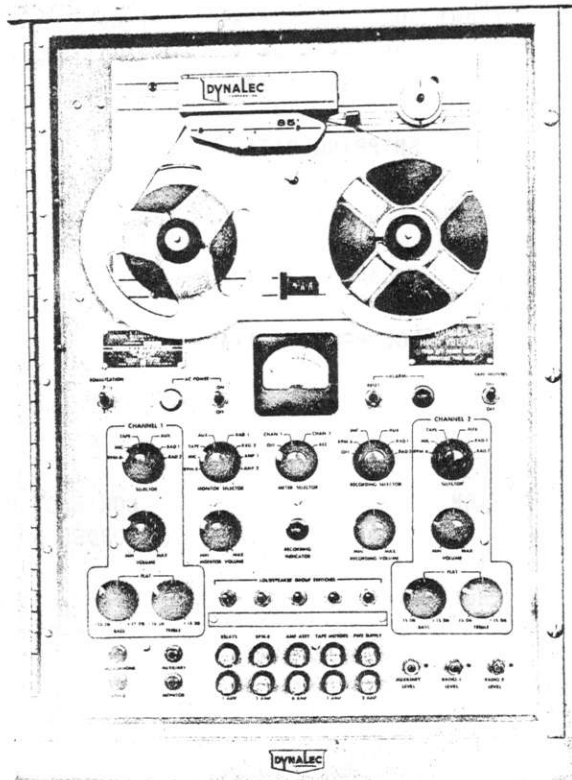

CONTROL, RECORDER-REPRODUCER C-3755/WIH

FUNCTIONAL DESCRIPTION:

Control, Recorder-Reproducer C-3766/WIH is essentially a two-channel audio console which functions as a program source control, amplifies, and supplies program material to the ship's loudspeaker groups. It provides for the simultaneous transmission of two programs with facilities for selecting as inputs: magnetic tape playback, either of two radio lines, or phone line. Facilities for microphone mixing, monitoring, and recording all inputs are provided.

No field changes in effect at time of preparation (1 July 1964).

RELATION TO OTHER EQUIPMENT:

C-3766/WIH CONTROL, RECORDER-REPRODUCER

EQUIPMENT REQUIRED BUT NOT SUPPLIED:

TECHNICAL CHARACTERISTICS:

TAPE SPEED: 3.75 or 7.5 in. per sec.

POWER REQUIREMENTS: 115 v, 60 cyc, single ph.

MAJOR COMPONENTS

QTY	ITEM	STOCK NUMBERS	DIMENSIONS (INCHES)	WEIGHT (LBS)
1	Control, Recorder-Reproducer C-3766/WIH		11-3/8 x 20 x 29-3/16	

REFERENCE DATA AND LITERATURE:

NAVSHIPS 365-2745: Technical Manual for Control, Recorder-Reproducer C-3766/WIH and Amplifier Assembly AM-3051/WIH.

TUBE, CRYSTAL AND/OR SEMI-CONDUCTOR DATA:

TUBES: (1) 5R4GY (3) 12AU74 (3) 7025 (3) 7247

CRYSTALS: None used.

SEMI-CONDUCTORS: None used.

SHIPPING DATA

PKGS	VOLUME (CU FT)	WEIGHT (LBS)
------	----------------	--------------

PROCUREMENT DATA

PROCURING SERVICE: USN

DESIGN COG: USN, BuShips

SPEC &/OR DWG: MIL-A-17053D(SHIPS)

CONTRACTOR	LOCATION	CONTRACT OR ORDER NO.	APPROX. UNIT COST
Dynatec Corporation	Rochester, New York	NObs(24-126)-84227	

27 July 1964

Cog Service: USN FSN:

CONTROL, RECORDER-REPRODUCER C-3766A/WIH

Functional Class:

USA

USN

USAF

TYPE CLASS:

Used by

MANUFACTURER'S NAME/CODE NUMBER: U. S. Recording Co., (81798).

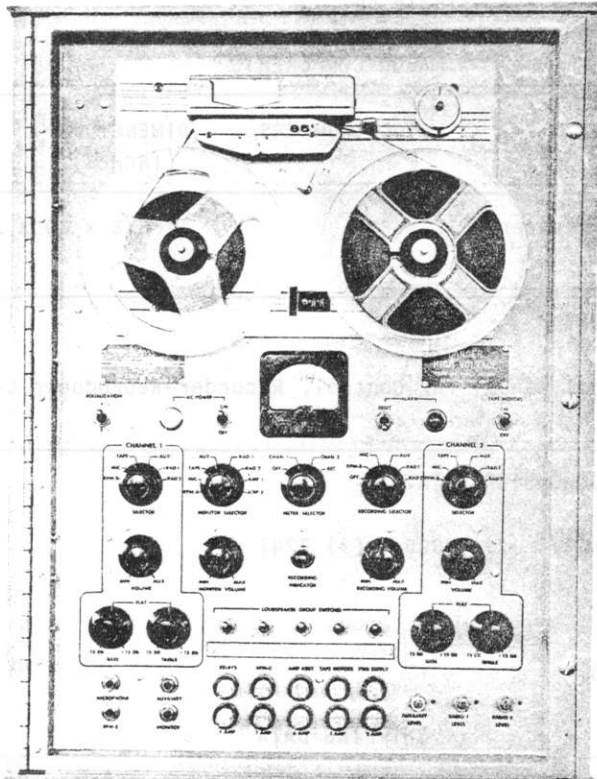

CONTROL, RECORDER-REPRODUCER C-3766A/WIH

FUNCTIONAL DESCRIPTION:

Control, Recorder-Reproducer C-3766A/WIH is essentially a two-channel audio console which functions as a program source control, amplifies, and supplies program material to the ship's loudspeaker groups. It provides for the simultaneous transmission of two programs with facilities for selecting as inputs: magnetic tape playback, either of two radio lines, or phone line. Facilities for microphone mixing, monitoring, and recording all inputs are provided.

No field changes in effect at time of preparation (1 July 1964).

RELATION TO OTHER EQUIPMENT:

C-3766A/WIH CONTROL, RECORDER-REPRODUCER

EQUIPMENT REQUIRED BUT NOT SUPPLIED:

TECHNICAL CHARACTERISTICS:

TAPE SPEED: 3.75 or 7.5 in. per sec.

POWER REQUIREMENTS: 115 v, 60 cyc, single ph.

MAJOR COMPONENTS

QTY	ITEM	STOCK NUMBERS	DIMENSIONS (INCHES)	WEIGHT (LBS)
1	Control, Recorder-Reproducer C-3766A/WIH		11 x 20 x 29-1/4	

REFERENCE DATA AND LITERATURE:

NAVSHIPS 365-2847: Technical Manual for Control, Recorder-Reproducer C-3766A/WIH and Amplifier Assembly AM-3051A/WIH.

TUBE, CRYSTAL AND/OR SEMI-CONDUCTOR DATA:

TUBES: (1) 5R4GY (3) 12AU7A (3) 7025 (3) 7247

CRYSTALS: None used.

SEMI-CONDUCTORS: None used.

SHIPPING DATA

PKGS	VOLUME (CU FT)	WEIGHT (LBS)
------	----------------	--------------

PROCUREMENT DATA

PROCURING SERVICE: USN

DESIGN COG: USN, BuShips

SPEC &/OR DWG: MIL-A-17053D(SHIPS)

CONTRACTOR	LOCATION	CONTRACT OR ORDER NO.	APPROX. UNIT COST
U. S. Recording Co.	Washington, D. C.	N0bs(24-126)-88340	\$927.08

27 July 1964

CONTROL, RADIO SET C-3840/A

Cog Service: USN FSN:

Functional Class:

USA

USN

USAF

TYPE CLASS:

Used by

MANUFACTURER'S NAME/CODE NUMBER: Texas Instruments Inc., (96214).

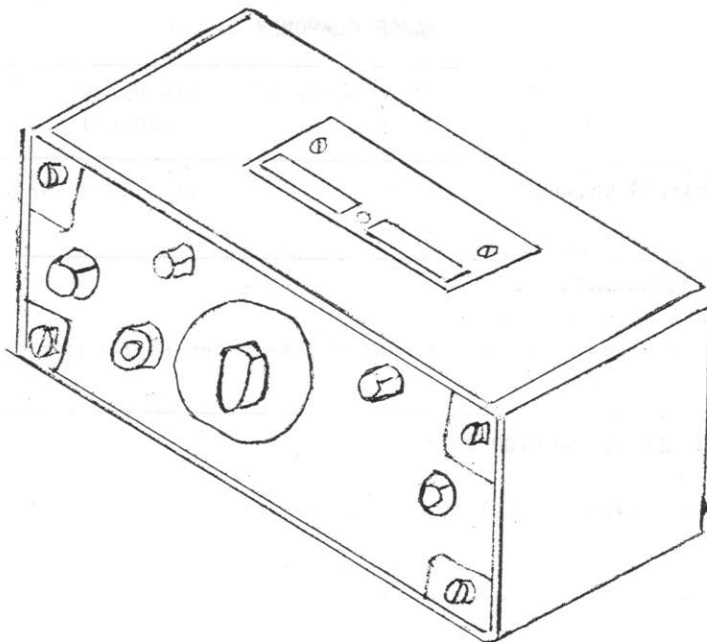

CONTROL, RADIO SET C-3840/A

FUNCTIONAL DESCRIPTION:

Control, Radio Set C-3840/A remotely controls the transfer of the AN/ARA-25(UHF) automatic direction finding group from UHF/ADF mode of operation to SONOBUOY on-top position indicating mode of operation.

No field changes in effect at time of preparation (1 July 1964).

RELATION TO OTHER EQUIPMENT:

EQUIPMENT REQUIRED BUT NOT SUPPLIED:

C-3840/A CONTROL, RADIO SET

TECHNICAL CHARACTERISTICS:

TYPE OF CONTROL: Manual.

POWER REQUIREMENTS: 28 v dc.

HEAT DISSIPATION: 8.5 W.

MOUNTING: Rack mtd.

MAJOR COMPONENTS

QTY	ITEM	STOCK NUMBERS	DIMENSIONS (INCHES)	WEIGHT (LBS)
1	Control, Radio Set C-3840/A	R5826-887-1939	2-1/4 x 3-5/8 x 5-3/8	1.50

REFERENCE DATA AND LITERATURE:

NAVWEPS 16-45-81: Handbook of Overhaul Instructions for Radio Receiver Control C-3840/A.

TUBE, CRYSTAL AND/OR SEMI-CONDUCTOR DATA:

TUBES: None used.

CRYSTALS: None used.

SEMI-CONDUCTORS: (4) 1N645

SHIPPING DATA

PKGS	VOLUME (CU FT)	WEIGHT (LBS)
------	----------------	--------------

PROCUREMENT DATA

PROCURING SERVICE: USN

DESIGN COG: USN, BuWeps

SPEC &/OR DWG:

CONTRACTOR	LOCATION	CONTRACT OR ORDER NO.	APPROX. UNIT COST
Texas Instruments Inc., Part No. 428895-1	Dallas, Texas	N0as 59-0261	

16 August 1967

Cog Service: USN

FSN:

CONTROL, RADIO SET C-4373/URC-45

Functional Class:

USA

USN

USAF

TYPE CLASS:

Used by

MANUFACTURER'S NAME/CODE NUMBER: Hammarlund Mfg. Co., Inc. (80583).

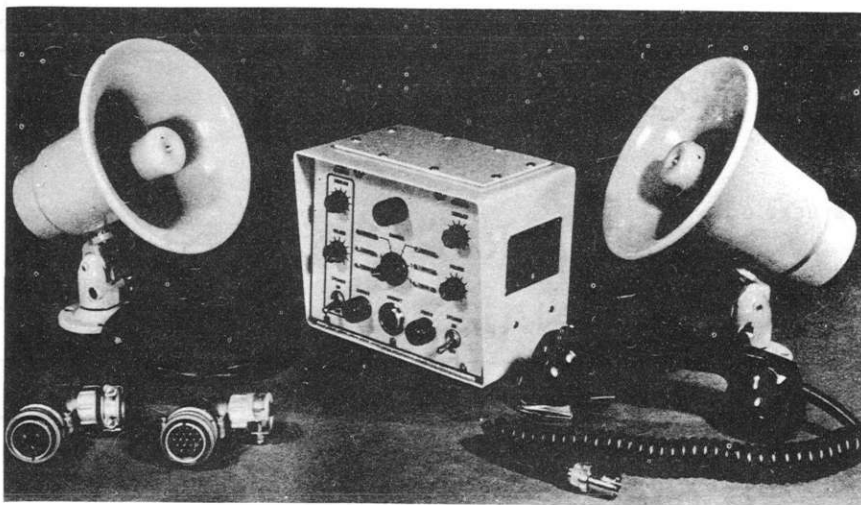

CONTROL, RADIO SET C-4373/URC-45

FUNCTIONAL DESCRIPTION:

The Control Radio Set C-4373/URC-45 provides basic remote controls except for squelch adjustment and frequency selector.

No field changes in effect at time of preparation (12 April 1966)

RELATION TO OTHER EQUIPMENT: None.

EQUIPMENT REQUIRED BUT NOT SUPPLIED: None.

TECHNICAL CHARACTERISTICS:

POWER REQUIREMENT: 117 vac, 60 cyc, single ph.

1.2 C-4373/URC-45: 1

CONTROL, RADIO SET C-4373/URC-45

MAJOR COMPONENTS

QTY	ITEM	DIMENSIONS (INCHES)	WEIGHT (LBS)
1	Control Radio Set: C-4373/URC-45	5-7/16 x 6-1/2 x 8	

REFERENCE DATA AND LITERATURE:

Hammarlund Mfg. Co., Inc.: Technical Manual for VHF-FM Radio Set AN/URC-45.

SHIPPING DATA

PKGS VOLUME (CU FT) WEIGHT (LBS)

PROCUREMENT DATA

PROCURING SERVICE: USN
SPEC &/OR DWG:

DESIGN COG: USN, USCG

CONTRACTOR

LOCATION

**CONTRACT OR
ORDER NO.**

**APPROX.
UNIT COST**

Hammarlung Mfg. Co., Inc. New York, N.Y.

TCG-42024

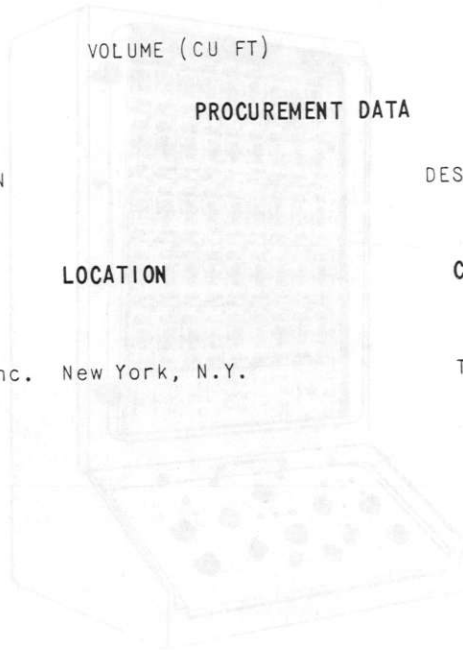

773

7 July 1965

Cog Service: USN FSN:

CONTROL DATA TERMINAL SET C-4577/SSQ-29

Functional Class:

USA

USN

USAF

TYPE CLASS:

Used by

MANUFACTURER'S NAME/CODE NUMBER: Collins Radio Company Dallas Div., (95104).

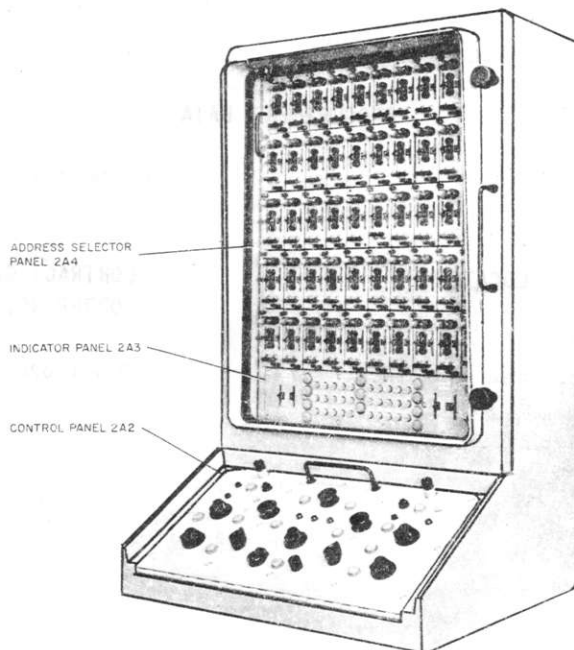

CONTROL DATA TERMINAL SET C-4577/SSQ-29

FUNCTIONAL DESCRIPTION:

Control Data Terminal Set C-4577/SSQ-29 provides the means to control the operation of equipment from a remote position. This unit mounts major controls and indicators corresponding to those of the Data Terminal Group OA-4477/SSQ-29. After the prescribed setting of controls on both equipments, semi-automatic operation is accomplished from the Control Data Terminal Set.

The Control Data Terminal Set consists of an equipment chassis rack, control panel, indicator panel, and an address-selector panel (card cage) containing fifty address-selector assemblies. The chassis rack is constructed of preformed sheet aluminum welded to a rid.

No field changes in effect at time of preparation (1 June 1965).

RELATION TO OTHER EQUIPMENT: None.

CONTROL DATA TERMINAL SET C-4577/SSQ-29

EQUIPMENT REQUIRED BUT NOT SUPPLIED: None.

TECHNICAL CHARACTERISTICS:

POWER REQUIREMENTS: 115 v, 400 cps, three ph, 135 va, 1.0 pf; + 28 v dc (for indicator lamps).

MAJOR COMPONENTS

QTY	ITEM	STOCK NUMBERS	DIMENSIONS (INCHES)	WEIGHT (LBS)
1	Control Data Terminal Set C-4577/SSQ-29		16-3/4 x 18-3/4 x 31	115

REFERENCE DATA AND LITERATURE:

NAVSHIPS 94718(A): Technical Manual for Data Terminal Set AN/SSQ-29(U).

TUBE, CRYSTAL AND/OR SEMI-CONDUCTOR DATA:

TUBES: Not available.

CRYSTALS: Not available.

SEMI-CONDUCTORS: Not available.

SHIPPING DATA

PKGS	VOLUME (CU FT)	WEIGHT (LBS)
1	14	200

PROCUREMENT DATA

PROCURING SERVICE: USN DESIGN COG: USN, BuShips
SPEC &/OR DWG:

CONTRACTOR	LOCATION	CONTRACT OR ORDER NO.	APPROX. UNIT COST
Collins Radio Co. Dallas Div.	Dallas, Texas	N0bsr-87224	

775

24 July 1964

Cog Service: USN

FSN: 2F5820-996-5180

CONTROL, TRANSMITTER C-4621/SR

Functional Class:

USA

USN

USAF

TYPE CLASS:

Std

MANUFACTURER'S NAME/CODE NUMBER: Electro International Inc.

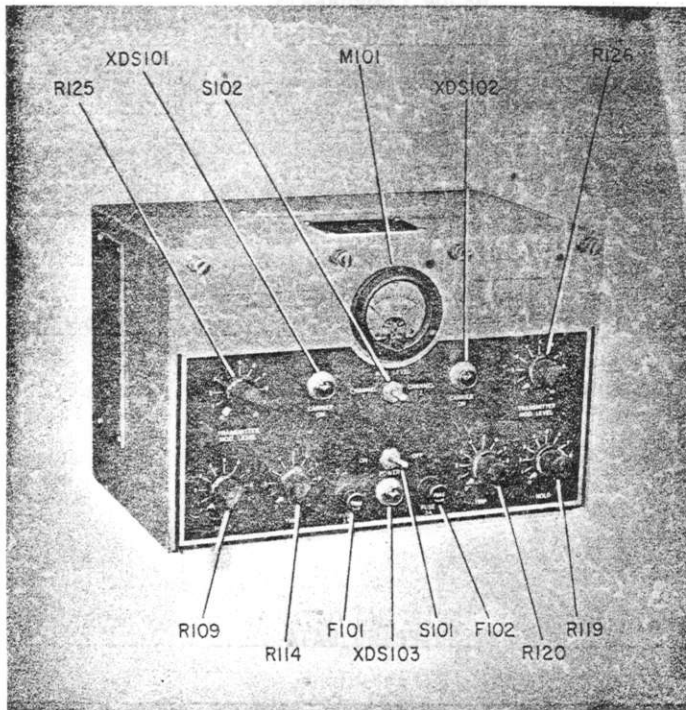

CONTROL, TRANSMITTER C-4621/SR

FUNCTIONAL DESCRIPTION:

Control, Transmitter C-4621/SR is a general purpose equipment which functions primarily as an audio relay. It is designed for use with standard Navy receivers and transmitters and allows received audio to key and modulate a local transmitter.

No field changes in effect at time of preparation (1 July 1964).

RELATION TO OTHER EQUIPMENT:

EQUIPMENT REQUIRED BUT NOT SUPPLIED:

C-4621/SR CONTROL, TRANSMITTER

TECHNICAL CHARACTERISTICS:

POWER REQUIREMENTS: 115 v, 60 cyc, single ph.
NUMBER OF CHANNELS: 2 (1 receiver and 1 transmitter).
OPERATION: Automatic (completely unattended).

MAJOR COMPONENTS

QTY	ITEM	STOCK NUMBERS	DIMENSIONS (INCHES)	WEIGHT (LBS)
1	Control, Transmitter C-4621/SR	2F5820-996-5180	8 x 8-1/2 x 12-3/4	

REFERENCE DATA AND LITERATURE:

NAVSHIPS 94794: Technical Manual for Control, Transmitter C-4621/SR.

TUBE, CRYSTAL AND/OR SEMI-CONDUCTOR DATA:

TUBES: (1) 12AT7WA (2) 12AX7/5751WA

CRYSTALS: None used.

SEMI-CONDUCTORS: (4) 1N1763 (1) 1N2389

SHIPPING DATA

PKGS	VOLUME (CU FT)	WEIGHT (LBS)
------	----------------	--------------

PROCUREMENT DATA

PROCURING SERVICE: USN DESIGN COG: USN, BuShips
SPEC &/OR DWG: RH-23-F-1752 Rev A

CONTRACTOR	LOCATION	CONTRACT OR ORDER NO.	APPROX. UNIT COST
Electro International Inc.	Annapolis, Md.	N191-49486	\$233.80

28 November 1966

CONTROLLER COMPARATOR C-4634A/GYK-4

Cog Service: USN

FSN:

Functional Class:

USA

USN

USAF

TYPE CLASS:

Used by

MANUFACTURER'S NAME/CODE NUMBER:

Burroughs Corporation Defense and Space Group (15416).

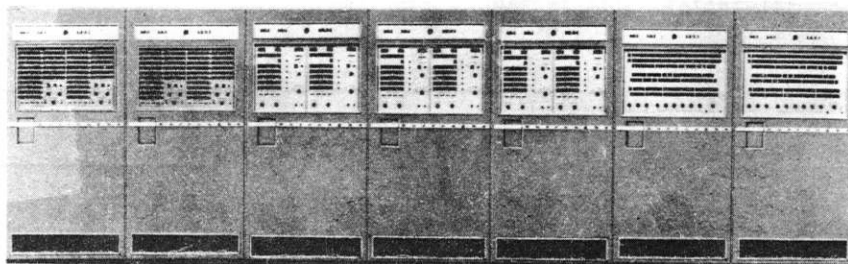

CONTROLLER COMPARATOR C-4634A/GYK-4

FUNCTIONAL DESCRIPTION:

Controller Comparator C-4634A/GYK-4 provides the control signals, parity checks, time interphase and data transformation required by the Digital Data Processing System. The equipment has self-contained power supply and control panel and contains two modules. Each module consists of a descriptor register, and associated decoding circuitry, full word data register, and a two character buffer register with associated timing and control circuits. The Controller Comparator controls the input/output operations initiated by the computer for the Digital Data Processing System.

No field changes in effect at time of preparation (25 May 1966).

RELATION TO OTHER EQUIPMENT:

The C-4634A/GYK-4 is one-way interchangeable with C-4634/GYK-4.

CONTROLLER COMPARATOR C-4634A/GYK-4

EQUIPMENT REQUIRED BUT NOT SUPPLIED:

(1) Computer Digital Data CP-719A/GYK-4; (1) Core Memory Unit MU-468A/GYK-4.

TECHNICAL CHARACTERISTICS:

POWER REQUIREMENTS

VOLTAGE: 120/208 v ± 10%.

FREQUENCY: 60 cps.

PHASE: 3.

POWER: 2.22 kva.

POWER FACTOR: 0.934.

HEAT DISSIPATION: 7063 BTU per hr.

AMBIENT TEMPERATURE: 32 to 104° F.

RELATIVE HUMIDITY: 95% max.

AMBIENT LIGHTING: 50 foot candles max.

DATA TRANSFER RATE TO MEMORY: 1.67 usec per word and 333 usec per 12 bit syllable.

DATA TRANSFER RATE TO TERMINAL EQUIPMENT: 2 usec per 6 bit character (max).

MAJOR COMPONENTS

QTY	ITEM	DIMENSIONS (INCHES)	WEIGHT (LBS)
2	Controller Comparator C-4634A/GYK-4	28 x 39 x 80	1680

REFERENCE DATA AND LITERATURE:

NAVSHIPS 96053: Technical Manual for Controller-Comparator C-4634A/GYK-4.

SHIPPING DATA

PKGS	VOLUME (CU FT)	WEIGHT (LBS)
1	93	2130

PROCUREMENT DATA

PROCURING SERVICE: USN

DESIGN COG: USN, NavShips

SPEC &/OR DWG: SHIPS-D-4542

CONTRACTOR	LOCATION	CONTRACT OR ORDER NO.	APPROX. UNIT COST
Burroughs Corporation Defense and Space Group	Paoli, Penn.	NObsr 91181	

779

24 July 1964

Cog Service: USN FSN: 2F5820-996-2217

CONTROL, RADIO SET C-4668/FRC

Functional Class:

USA

USN

USAF

TYPE CLASS:

Std

MANUFACTURER'S NAME/CODE NUMBER: General Electric, Communication Products Dept., (08771).

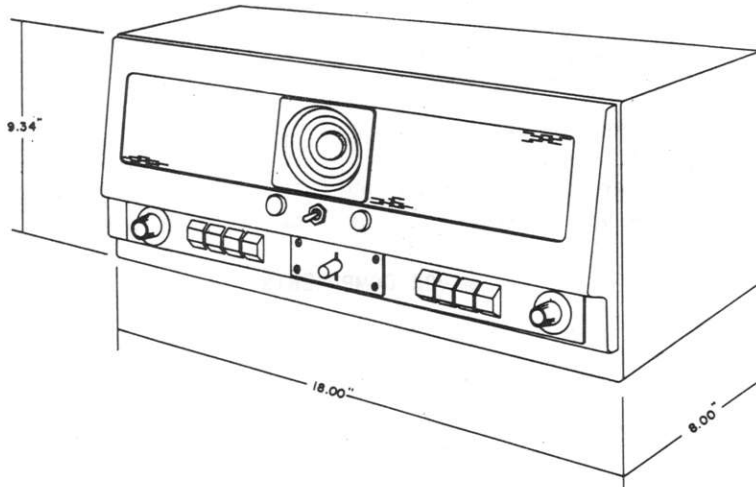

NOTE:

1. MAXIMUM OVERALL DEPTH OF CONTROL UNIT IS 10.00."
2. TO REMOVE CHASSIS FROM CABINET TAKE OUT WING SCREWS FROM REAR OF CABINET AND REMOVE CHASSIS WITH FRONT PANEL.

CONTROL, RADIO SET C-4668/FRC

FUNCTIONAL DESCRIPTION:

Control, Radio Set C-4668/FRC is used with a Remote Control Panel to control a single frequency transmitter and a single frequency receiver.

No field changes in effect at time of preparation (1 July 1964).

RELATION TO OTHER EQUIPMENT:

EQUIPMENT REQUIRED BUT NOT SUPPLIED:

C-4668/FRC CONTROL, RADIO SET

TECHNICAL CHARACTERISTICS:**LINE AMPLIFIER**

INPUT: - 12 dbm min; 600/250/100/30 ohms.
FREQUENCY RESPONSE: ± 2 db, 200 to 5,000 cps (1,000 cps ref).
DISTORTION: Less than 3% at rated output.
NOISE: More than 50 db below 3 W.
OUTPUT: 3 W max into 3.5 ohms speaker.

MICROPHONE AMPLIFIER

INPUT: Designed for high-impedance low-level microphone.
FREQUENCY RESPONSE: ± 3 db, 200 to 5,000 cps.
DISTORTION: Less than 5% o/a.
NOISE: Better than 50 db below rated output.
OUTPUT: + 18 dbm (+ 8 VU) max.
LEVEL INDICATOR: VU meter.

CONTROL CIRCUITS

TRANSMIT: 40 to 135 v dc (adjustable).
SQUELCH: 0 to 15 v dc (neg).
MICROPHONE: Type EM-9-B; controlled magnetic with desk stand.
POWER REQUIREMENTS: 117 v $\pm 10\%$, 50 to 60 cyc, single ph, 60 W.

MAJOR COMPONENTS

QTY	ITEM	STOCK NUMBERS	DIMENSIONS (INCHES)	WEIGHT (LBS)
1	Control, Radio Set C-4668/FRC	2F5820-996-2217	9-1/4 x 9-7/8 x 18	27.5

REFERENCE DATA AND LITERATURE:

NAVSHIPS 94705: Technical Manual for Radio Set Control C-4668/FRC.

TUBE, CRYSTAL AND/OR SEMI-CONDUCTOR DATA:

TUBES: (1) 5Y3GT (1) 6AQ5/6669 (1) 12AU7/6680 (1) 12AX7/6681

CRYSTALS: None used.

SEMI-CONDUCTORS: None used.

SHIPPING DATA

PKGS	VOLUME (CU FT)	WEIGHT (LBS)
------	----------------	--------------

PROCUREMENT DATA

PROCURING SERVICE: USN

DESIGN COG: USMC

SPEC &/OR DWG:

1.2 C-4668/FRC: 2

CONTRACTOR	LOCATION	CONTRACT OR ORDER NO.	APPROX. UNIT COST
General Electric, Communication Products Dept	Lynchburg, Virginia	N0bsr-87643	

24 July 1964

CONTROL, RECEIVER C-4674/U

Cog Service: USN FSN: 2F5815-994-9860

Functional Class:

USA

USN

USAF

TYPE CLASS:

Std

MANUFACTURER'S NAME/CODE NUMBER: Communication Electronics Inc., (14632).

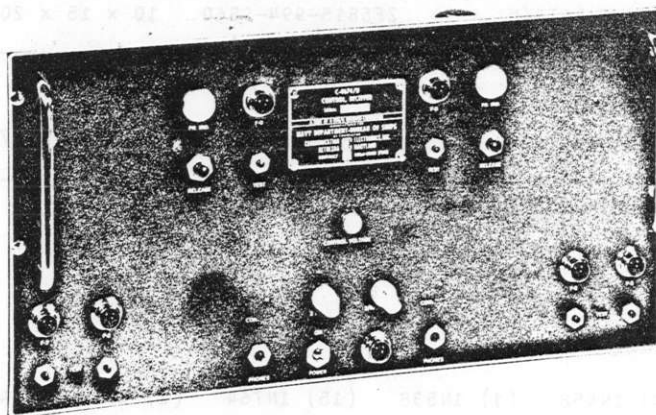

CONTROL, RECEIVER C-4674/U

FUNCTIONAL DESCRIPTION:

Control, Receiver C-4674/U is one unit of the Receiver-Converter R-958/U and as such is designed to be used in conjunction with the IF output from two radio receivers and various remote terminal equipment. The C-4674/U receives and discriminates between incoming signals in a very narrow, precise frequency range and then, as a function of time, causes indicator lamps to light and relays to operate which control various functions in associated, remote terminal equipment.

No field changes in effect at time of preparation (1 July 1964).

RELATION TO OTHER EQUIPMENT:

C-4674/U CONTROL, RECEIVER

EQUIPMENT REQUIRED BUT NOT SUPPLIED:

TECHNICAL CHARACTERISTICS:

POWER REQUIREMENTS: 115 v, 60 cyc, single ph.

MAJOR COMPONENTS

QTY	ITEM	STOCK NUMBERS	DIMENSIONS (INCHES)	WEIGHT (LBS)
1	Control, Receiver C-4674/U	2F5815-994-9860	10 x 15 x 20	

REFERENCE DATA AND LITERATURE:

NAVSHIPS 94698(A): Technical Manual for Receiver Control Unit C-4674/U.

TUBE, CRYSTAL AND/OR SEMI-CONDUCTOR DATA:

TUBES: (2) 0A2WA (8) 12AT7WA (5) 6211

CRYSTALS: None used.

SEMI-CONDUCTORS: (24) 1N458 (1) 1N538 (15) 1N764 (2) 1N769 (4) 1N1095 (2) 1N3017A

SHIPPING DATA

PKGS	VOLUME (CU FT)	WEIGHT (LBS)
------	----------------	--------------

PROCUREMENT DATA

PROCURING SERVICE: USN
SPEC &/OR DWG:

DESIGN COG: USN, BuShips

CONTRACTOR	LOCATION	CONTRACT OR ORDER NO.	APPROX. UNIT COST
Communication Electronics Inc.	Bethesda, Md.	N0bsr-89101(FBM) N0bsr-91025(FBM)	\$1,905.15 \$1,318.00

21 November 1966

ANTENNA CONTROL-TRANSMITTER KEYER C-4882/WRT

Cog Service: USN FSN:

Functional Class:

USA

USN

USAF

TYPE CLASS:

Used by

MANUFACTURER'S NAME/CODE NUMBER: Westinghouse Electric Corporation, Electronics Div., (89661).

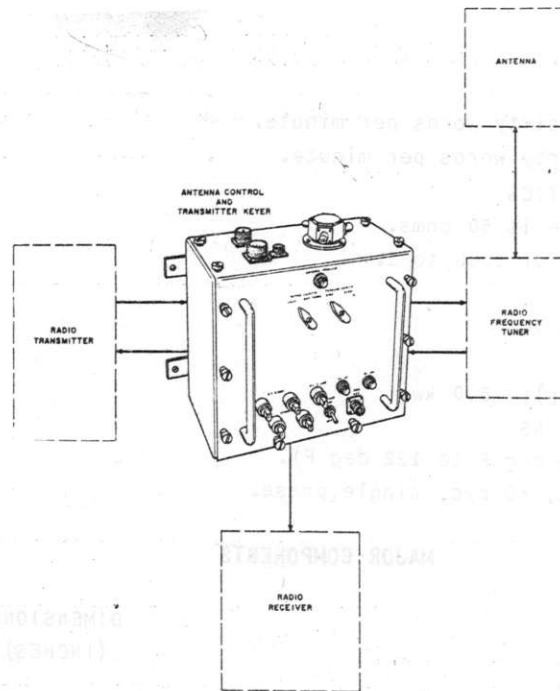

ANTENNA CONTROL-TRANSMITTER KEYER C-4882/WRT

FUNCTIONAL DESCRIPTION:

The Antenna Control-Transmitter Keyer C-4882/WRT is designed to provide break-in operating facilities by automatically switching the antenna from the transmitter to the receiver. This break-in operation is accomplished by employing antenna transfer contacts that connect the antenna to the receiver when the key is open, and to the transmitter when the key is closed. The keying relays within the antenna control-transmitter keyer are designed in such a manner that the antenna transfer contacts are never required to break the antenna current.

No field changes in effect at time of preparation (21 July 1966).

RELATION TO OTHER EQUIPMENT:

The C-4882/WRT is similar to C-1670/U; functionally interchangeable. Unit performs essentially the same function as C-1670/U. The chief difference is in the Antenna Transfer

ANTENNA CONTROL-TRANSMITTER KEYER C-4882/WRT

Relay. This control antenna will operate at power of 2 KW D.E.P. up to 30 mc W/SWR of less than 1.15 to 1, this is not possible w/C-1670/U.

EQUIPMENT REQUIRED BUT NOT SUPPLIED:

(1) Radio Transmitting Set, AN/WRT-2 or AN/WRT-4; (1) Multimeter, AN/PSM-4C; (1) Oscilloscope, AN/USM-117; (1) Vari-Speed Keyer, Boehme Type 66-M; (1) Antenna Tuner; (1) Whip Antenna; (1) Radio Receiver.

TECHNICAL CHARACTERISTICS:

FREQUENCY RANGE: 2 to 30 mc.

KEYING SPEEDS

Break-in-operation up to sixty words per minute.

Local operation up to thirty words per minute.

INPUT AND OUTPUT CHARACTERISTICS

Input and output impedance is 50 ohms.

POWER CAPABILITY: With VSWR of 1.05 to 1.

AVERAGE POWER: 500 W.

PEAK ENVELOPE POWER: 2.0 kw.

HAND-KEYED CW: 1.0 kw.

MACHINE CW (SHORT INTERVAL): 5.0 kw.

AMBIENT TEMPERATURE LIMITATIONS

0 deg C to 50 deg C (+ 32 deg F to 122 deg F).

POWER REQUIREMENT: 115 v ac, 60 cyc, single phase.

MAJOR COMPONENTS

QTY	ITEM	DIMENSIONS (INCHES)	WEIGHT (LBS)
1	Antenna Control Transmitter keyer C-4882/WRT includes:	8-5/8 x 12-7/8 x 15-1/4	30
2	Technical Manuals	1/2 x 8-1/2 x 11	

REFERENCE DATA AND LITERATURE:

NAVSHIPS 94248(A): Technical Manual for Antenna Control-Transmitter keyer C-4882/WRT.
0967-134-9010: Technical Manual for Antenna Control-Transmitter Keyer C-4882/WRT.

SHIPPING DATA

PKGS	VOLUME (CU FT)	WEIGHT (LBS)
1	2.0	40

1.2 C-4882/WRT: 2

ANTENNA CONTROL-TRANSMITTER KEYER C-4882/WRT

PROCUREMENT DATA

PROCURING SERVICE: USN
SPEC &/OR DWG: SHIPS-A-3727

DESIGN COG: USN, NavShips

CONTRACTOR	LOCATION	CONTRACT OR ORDER NO.	APPROX. UNIT COST
Westinghouse Electric Corp., Electronics Division, Defense Center	Baltimore, Md.	N0bsr-85309	

787

31 August 1967

Cog Service: USN FSM:

CONTROL, TRANSMITTER C-6652/URT

Functional Class:

USA

USN

USAF

TYPE CLASS:

Used by

MANUFACTURER'S NAME/CODE NUMBER: Technical Material Corporation, (82679).



CONTROL, TRANSMITTER C-6652/URT

FUNCTIONAL DESCRIPTION:

Control, Transmitter C-6652/URT performs control, monitor, and keyer functions for the AN/FRT-39 series transmitters. The control function provides remote voice-operated control for the transmitter, and reduces power consumption during standby periods by automatically removing exciter B+, and biasing off IPA and PA quiescent current. Keying voltages, or a sample of the audio input to the transmitter, are monitored. Front panel visible indication of failure of keying or audio input, transmitter PA plate voltage, and transmitter RF output is provided by the monitor unit. Relays within the unit allow extension of these indications to operating consoles, etc. FAILURE, READY, and ON AIR indicator lights may be located at the transmitter, or at a remote operating position. The keyer function allows tone or dc keying with any keying voltage from 50 v dc to 100 v dc, and current keying with any current from 20 ma to 60 ma. A threshold adjustment exactly matches the C-6652/URT to the keying voltage or current and the key lines used.

No field changes in effect at time of preparation (3 January 1967).

RELATION TO OTHER EQUIPMENT: None.

1.2 C-6652/URT: 1

CONTROL, TRANSMITTER C-6652/URT

EQUIPMENT REQUIRED BUT NOT SUPPLIED: None.

TECHNICAL CHARACTERISTICS:

KEYER INPUT: 20 v dc to 100 v dc; 20 ma to 60 ma; Tone Keying, 600 ohm or 5000 ohm impedance.

KEYER OUTPUT: One set DPDT contacts; fast actuate, adjustable release relay.

MONITOR INPUT: Audio-300 cps to 6000 cps; RF-0.5 v rms; ac-230 v rms.

MONITOR OUTPUT

READY RELAY: Closed when transmitter plate voltage is on. Opens when ON AIR relay closes.

ON AIR RELAY: Closed when audio or keying present, transmitter plate voltage on, and RF output present.

FAILURE RELAY: Closed when transmitter RF output fails, opens and closes at 1 cps rate if keying or audio input fails with transmitter RF output present.

RELAY DELAYS: Application of transmitter plate voltage - no delay for READY relay to close; application of keying or audio input - 1/4 sec delay before ON AIR relay closes; failure of keying or audio input - 1 sec before ON AIR relay opens, 8 sec before FAILURE relay opens and closes at 1 cps rate; application of transmitter RF - no delay before ON AIR relay closes; failure of transmitter RF - 1-1/2 sec before ON AIR relay opens 1-1/2 sec before FAILURE relay closes.

POWER REQUIREMENTS: 115 or 230 v ac, single ph, 50 to 60 cyc, 10 W.

MAJOR COMPONENTS

QTY	ITEM	DIMENSIONS (INCHES)	WEIGHT (LBS)
1	Control, Transmitter C-6652/URT	5-1/4 x 10-3/8 x 19	15

REFERENCE DATA AND LITERATURE:

Manuscript for Control, Transmitter, C-6652/URT.

SHIPPING DATA

PKGS	VOLUME (CU FT)	WEIGHT (LBS)
1	4.7	71

PROCUREMENT DATA

PROCURING SERVICE: USN
SPEC &/OR DWG:

DESIGN COG: USN, NavShips

CONTRACTOR	LOCATION	CONTRACT OR ORDER NO.	APPROX. UNIT COST
Technical Material Corp.	Mamaroneck, New York	N600-(63133-11-126)- 63002	

31 August 1967

Cog Service: USN FSN:

CONTROL, RADIO SET C-6816(XN-1)/SRC-27

Functional Class:

USA

USN

USAF

TYPE CLASS:

Used by

MANUFACTURER'S NAME/CODE NUMBER: Electronic Communications Inc., (00724).

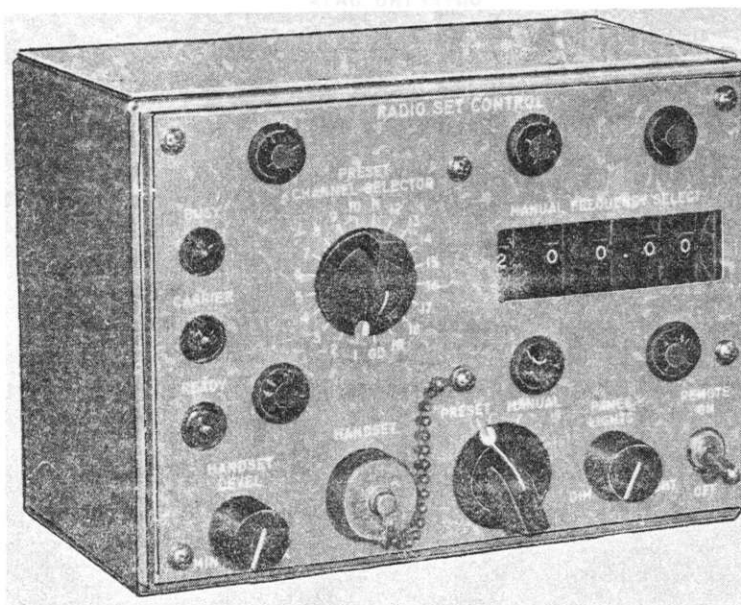

CONTROL, RADIO SET C-6816(XN-1)/SRC-27

FUNCTIONAL DESCRIPTION:

Control, Radio Set C-6816(XN-1)/SRC-27 is one of three types of remote control units used with Radio Set AN/SRC-27(XN-1). All remote control units except Radio Set Control C-1138/UR are interconnected so that the first remote control unit turned on is enabled, and all others are inhibited, permitting the use of only one remote control unit at a time. The Radio Set Control provides a handset connection preset or manual frequency selection, and monitoring of the remote control status. Any 1 of 20 preset frequencies in the range of 225.00 to 399.95 mc can be selected with the Preset Channel Selector Switch. Any 1 of 3500 frequencies in the range of 225 to 399.95 mc can be selected manually by dialing the Manual Frequency Select switches. When a remote control unit is enabled, the READY lamp on the enabled remote control unit lights, and the BUSY lamps on all remote control unit light. Whenever the transmitter is keyed, the CARRIER lamps on all remote control units light.

No field changes in effect at time of preparation (23 December 1966).

CONTROL, RADIO SET C-6816(XN-1)/SRC-27

RELATION TO OTHER EQUIPMENT:

The C-6816(XN-1)/SRC-27 is similar to C-6817(XN-1)SRC-27 and C-1138/UR. The C-6817(XN-1) SRC-27 does not provide the 3500 frequency selection function or handset plug-in capabilities. The C-1138/UR does not provide a frequency selection function.

EQUIPMENT REQUIRED BUT NOT SUPPLIED:

(1) Test Cable; (1) Handset H-169/U; (1) Audio Oscillator, AN/URM-127; (1) Vacuum Tube Voltmeter AN/USM-116; (1) Power Supply 28 v dc; (1) Power Supply 12 v dc; (1) Junction Box.

TECHNICAL CHARACTERISTICS:

POWER REQUIREMENTS: 28 v dc \pm 5%, 15 W max; 12 v dc \pm 10%, 6 W max.

TYPES OF OPERATION: Preset or manual.

PRESET FREQUENCY SELECTION: 225.00 to 399.95 mc, 20 channels, ea of a predetermined freq.

MANUAL FREQUENCY SELECTION: 225.00 to 399.95 mc, 3500 channels in 50 kc increments.

MAJOR COMPONENTS

QTY	ITEM	DIMENSIONS (INCHES)	WEIGHT (LBS)
1	Control, Radio Set, C-6816(XN-1)/SRC-27	5.77 x 6.3 x 8.04	4

REFERENCE DATA AND LITERATURE:

NAVSHIPS 0967-154-0010: Technical Manual for Radio Set Control C-6816(XN-1)/SRC-27.

SHIPPING DATA

QTY	VOLUME (CU FT)	WEIGHT (LBS)
-----	----------------	--------------

PROCUREMENT DATA

PROCURING SERVICE: USN

DESIGN COG: USN, NavShips

SPEC &/OR DWG:

CONTRACTOR	LOCATION	CONTRACT OR ORDER NO.	APPROX.
Electronic Communications Incorporated	St. Petersburg, Fla.	NObsr 93108	

28 August 1967

CONTROL, RADIO SET C-6817(XN-1)/SRC-27

Cog Service: USN FSN:

Functional Class:

USA

USN

USAF

TYPE CLASS:

Used by

MANUFACTURER'S NAME/CODE NUMBER: Electronic Communications, Inc., (00724).

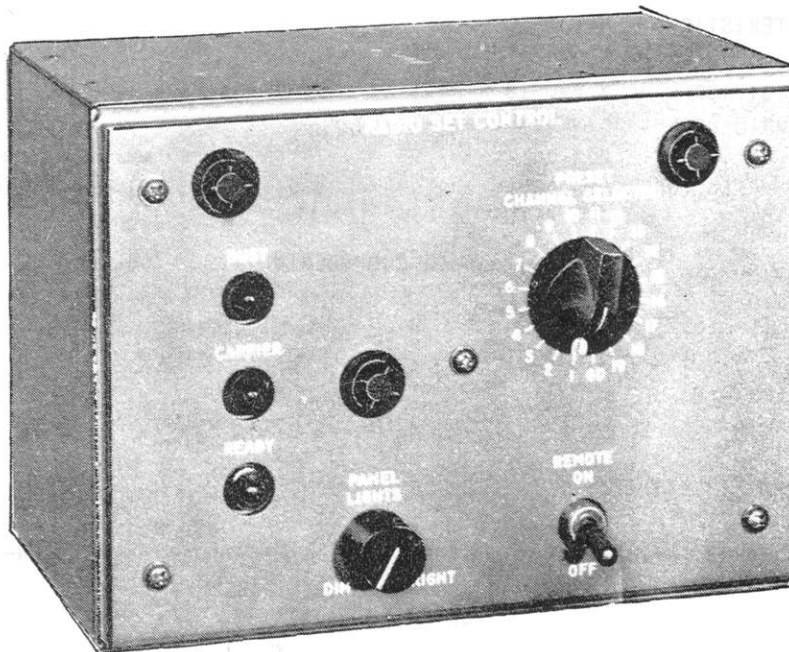

CONTROL, RADIO SET C-6817(XN-1)/SRC-27

FUNCTIONAL DESCRIPTION:

Control, Radio Set C-6817(XN-1)/SRC-27 is one of three types of remote control units used with Radio Set AN/SRC-27(XN-1). It provides preset frequency selection and monitoring of the remote control status. Any 1 of 20 preset frequencies in the range of 225.00 to 399.95 mc can be selected with the Preset Channel Selector switch. When a remote control unit is enabled, the READY lamp on the enabled remote controlled unit lights, and the BUSY lamps on all remote control units light. Whenever the transmitter is keyed, the CARRIER lamps on all remote control units light. The channel placarded GD tunes the transmitter and receiver of Radio Set AN/SRC-27(XN-1) to the guard frequency (238 to 248 mc or 273 to 283 mc).

No field changes in effect at time of preparation (27 December 1966).

RELATION TO OTHER EQUIPMENT:

The C-6817(XN-1)/SRC-27 is similar to C-6816(XN-1)/SRC-27 and C-1138/UR. The C-6817(XN-1)/SRC-27 does not provide the 3500 channel manual frequency selection and handset plug-in capabilities.

CONTROL, RADIO SET C-6817(XN-1)/SRC-27

EQUIPMENT REQUIRED BUT NOT SUPPLIED:

- (1) Test Cable; (1) Vacuum Tube Voltmeter AN/USM-116; (1) Power Supply 28 v dc;
- (1) Power Supply 12 v dc; (1) Junction Box.

TECHNICAL CHARACTERISTICS:

TYPE OF OPERATION: Preset.

FREQUENCY SELECTION: 225.00 to 399.95 mc, 20 channels, ea of a predetermined freq.

POWER REQUIREMENTS: 28 v dc ± 5%, 12 W max; 12 v dc ± 10% 6 W max.

MAJOR COMPONENTS

QTY	ITEM	DIMENSIONS (INCHES)	WEIGHT (LBS)
1	Control, Radio Set C-6817(XN-1)/SRC-27	5.77 x 6.3 x 8.04	4

REFERENCE DATA AND LITERATURE:

NAVSHIPS 0967-097-5010: Technical Manual for Radio Set Control, C-6817(XN-1)/SRC-27.

SHIPPING DATA

PKGS	VOLUME (CU FT)	WEIGHT (LBS)
------	----------------	--------------

PROCUREMENT DATA

PROCURING SERVICE: USN
SPEC &/OR DWG:

DESIGN COG: USN, NavShips

CONTRACTOR	LOCATION	CONTRACT OR ORDER NO.	APPROX. UNIT COST
Electronic Communications Inc.	St. Petersburg, Florida	NObsr 93108	

795