

34

CONFIDENTIAL

APRIL 1946

BUSHIPS

Electron

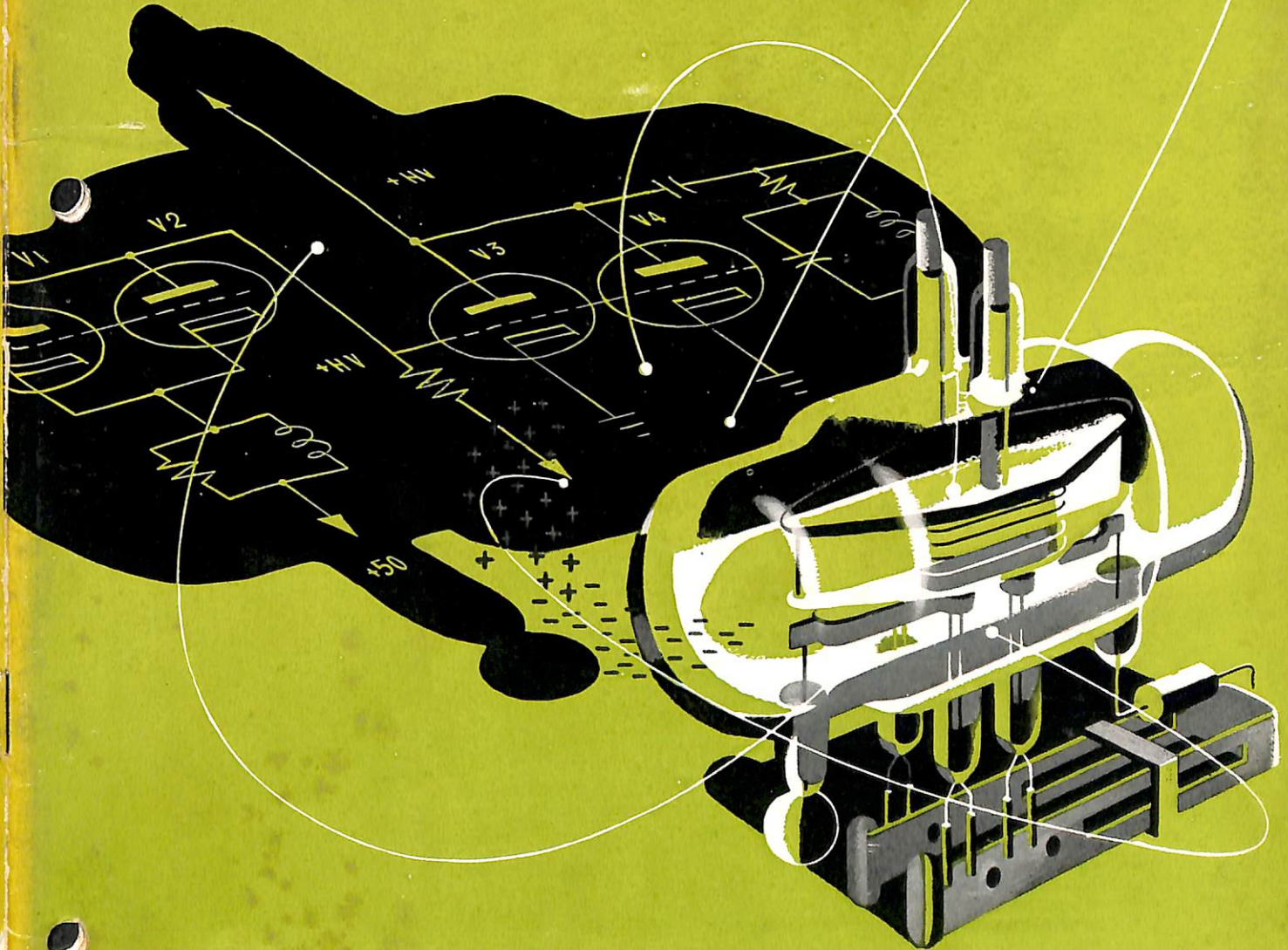

NavShips 900,100

<i>Electronics at the Crossroads</i>	1
<i>Mark 22 Field Change #5</i>	3
<i>UHF/VHF Installation Program</i>	4
<i>VTVM in Radar Distribution Switchboard</i>	6
<i>Type-D Nancy Communication System</i>	9
<i>Carrier Control Systems With VHF Radio</i>	12
<i>Model QFN Advanced Listening Teacher</i>	17
<i>The Field Engineer Sez:</i>	22
<i>The Forum</i>	23
<i>QAA Portable Echo-Ranging Equipment</i>	24
<i>PPM—New Technique</i>	26
<i>Tube Topics</i>	32

BUSHIPS

ELECTRON

A MONTHLY MAGAZINE FOR RADIO TECHNICIANS

DISTRIBUTION: BUSHIPS ELECTRON is sent to all activities concerned with the installation, operation, maintenance, and supply of electronic equipment. The quantity provided any activity is intended to permit convenient distribution—it is not intended to supply each reader with a personal copy. To this end, it is urged that new issues be passed along quickly. They may then be filed in a convenient location where interested personnel can read them more carefully. If the quantity supplied is not correct (either too few or too many) please advise us promptly.

CONTRIBUTIONS: Contributions to this magazine are always welcome. All material should be addressed to

The Editor, BuShips ELECTRON
Bureau of Ships (Code 993)
Navy Department
Washington 25, D. C.

and forwarded via the commanding officer. Whenever possible articles should be accompanied by appropriate sketches, diagrams, or photographs (preferably negatives).

CONFIDENTIAL: BUSHIPS ELECTRON has been classified confidential in order that information on all types of equipment may be included. It should be shown only to concerned personnel as provided in the U.S. Navy Regulations. Don't forget this includes enlisted personnel!!

BUSHIPS ELECTRON contains information affecting the national defense of the United States within the meaning of the Espionage Act (U.S.C. 50; 31, 32) as amended.

BUREAU OF SHIPS — NAVY DEPARTMENT



A Preview of Electronics at the Coming Atomic Bomb Test

■ When the B-29 drops its deadly load, a single atomic bomb, over Bikini Atoll, a hundred ships will be lying at anchor. Some will be directly beneath the deadly object while others will stretch far out towards the horizon and comparative safety. Were there any one close enough to observe, these ships would appear lifeless—devoid of all activity. But although these ships and the entire area may seem abandoned, electronics will be on duty to measure and describe every detail of the dramatic instants that will follow the explosion. Packed into these few moments will be months of preparations by thousands of individuals. They are moments which cannot be repeated; the unanswered question remains unanswered. A forgotten detail, a faulty equipment, can in an instant nullify a major portion of this preparation. Thus a tremendous responsibility will rest upon those who plan these tests and upon the men who will install the gear and make the last minute tests upon it.

The bomb test, Project *Crossroads* as it is called, will find electronic equipment in a triple role. The first of these will consist of subjecting equipments to varying degrees of exposure in order to measure its vulnerability

to injury in this new kind of explosion. The second will be to make certain measurements from which answers of scientific interest may be derived. The third is classed as service, since electronics will be the assisting force incidental to other tests, or to the operation as a whole.

It would obviously be impossible to tell this whole story in a single issue of ELECTRON. If we remember that some five hundred men will be concerned with the electronics aspects of the operation alone, it is evident that all we can do is sketch out some of the things that will be done in preparation, some of the questions for which answers will be sought.

DAMAGE TO EQUIPMENT

Determination of vulnerability to damage from the atomic explosion will of course be a prime consideration with respect to electronic equipment. For this purpose a wide variety of gear will be placed on the target ships, which will be disposed at distances ranging from the point of explosion to positions calculated to be relatively safe from damage. Careful examination of the equip-

CONFIDENTIAL 1

ment and its component parts following the explosion will yield the answer to this all-important question. Because of the variety of the exposure to the explosion, a complete analysis of damage as a function of distance will be possible. Similar data will be collected for the Army, since numerous Signal Corps equipments will be aboard the target ships.

In addition to these tests, five of the target ships, *Pennsylvania*, *Pensacola*, *Wainwright*, *Talbot*, and *Parche*, will carry equipment in operation, the performance of which will be monitored throughout the explosion. The technical problems of monitoring the equipment have been assigned to the Naval Research Laboratory. Included will be SG, SP, SV, ST, and Mark 8 radar, the TBL communications transmitter, and IFF gear. Monitoring will be accomplished in the case of radar by suitably modified countermeasures and radar search receivers. Camera attachments and oscillographs will assure that a continuous film record is made.

WATCHING THE EXPLOSION WITH RADAR

But all effort will not be directed merely to the subjection of equipment to damage. Various projects will be set up from which information will be gathered to fill in the complete story of the test and to give answers to scientific problems which ordinary laboratory techniques cannot provide.

One of the more interesting projects in this category consists of a complete radar shore installation on Aomoen Island, situated seven miles from the explosion point. From this site radar will continuously "observe" what happens during and immediately after the explosion. These radars will be in a position to maintain a constant scan of the target ships in the very center of the explosion. Thus the movement of the targets and their relative rates of sinking (if any) will be permanently recorded.

This station will not be manned, for the magnitude of the anticipated explosion will not permit exposure of personnel to the blast so close to the point of detonation. In view of the observation posts established in the original New Mexico tests at six miles, a question naturally arises as to why such elaborate methods of remote control are required at a distance of seven miles. The reason for this is that the bomb which will be dropped at Bikini is known as the "Nagasaki Type" and is many times more efficient than that used on the original tests.

REMOTE CONTROL

Much of the photographic and measuring equipment will require some means of being remotely started at the proper time, and the techniques to be employed are interesting from an electronics standpoint. It must be remembered that not only must a fool-proof method of

starting be devised but the critical time considerations must be taken into account. To coordinate so vast a series of tests and measurements taking place over hundreds and even thousands of miles of the earth's surface necessitates basic timing control. A camera started a few seconds too late, a recording device started too early, might either miss the all-important moments to which these preparations are directed or might provide data with a time reference that was ambiguous.

For these reasons the remote operating circuits will be integrally tied in with the basic timing controls. These aspects of the test are being handled by scientists from the Los Alamos Laboratory. The method to be employed consists of transmitting a carrier frequency modulated by five audio tones. Each of these tones will be accurately related to some predetermined instant of time. At the devices to be remotely controlled, these signals will be received by SCR-694 portable battery-operated receivers. Connected with the receiver will be a "black box" containing filter circuits designed to pass only the audio tone associated with the instant of time when control is desired. The filter output is amplified and then fed to suitable relays which will close the circuits being controlled. It is seen, then, that a means is obtained for controlling any function with the greatest accuracy with relation to the required time sequence.

The carrier will be put on the air by a TBM transmitter. The power level of these signals will be high, in the order of 1000 microvolts at the receiver. Thus there will be no danger of prematurely operating the controlled devices by stray signals emanating from transmitters not associated with the operation but employing the same frequency.

IONIZATION AND PROPAGATION STUDIES

Another function of the Aomoen Island set-up will be to measure the reflectivity of the actual explosion to radio frequency energy of various frequencies. The purpose of such measurements will be to determine the ionization density in the immediate vicinity of the explosion. Attempts at similar measurements in the New Mexico tests were inconclusive so that it is hoped with improved conditions and techniques more positive data will be obtained.

ELECTRONICS TO PROVIDE MANY SERVICES

So far we have mentioned only those aspects of the test which concern the gathering of data of direct interest to electronics people. But the role of Electronics in the *Crossroads* project is far greater than this, for many projects of great importance will be carried on as a service function to the primary tests.

First in the list of these is the problem of establishing and maintaining communications before, during, and

after the test. To recount the details of this communications system would in itself require an article many times the length of this one. But perhaps the magnitude of the task can best be understood if it is pointed out that the communications requirements for this operation will exceed those for any Pacific amphibious operation during the war. For this purpose a communications plan based on assault operations will be established. In addition to the normal communications requirements of a large task force, extensive press facilities will be provided. For this purpose alone, six diplexed radio teletypewriter channels will be established, thus providing twelve circuits. In addition complete radiophoto facilities will be set up for immediate transmission of photographs.

Television will also play an important part in the tests. At three carefully chosen points on the islands surrounding and about two miles distant from the point of explosion, television cameras and transmitters will "watch" the explosion and the events immediately following it. This equipment will be housed in seventy-five foot towers designed to withstand the estimated force. Aircraft equipment with television receivers will record these transmissions. The various observation ships will also carry television receivers. It is anticipated that from this set up much valuable data will be obtained on the formation and behavior of waterwaves occasioned by the blast. This aspect of the studies is being carried out as part of an extensive program of investigation by oceanographic specialists.

Sono-buoys will be used to detect and transmit data useful in the studies of various shock- and compression-wave propagation. Such devices are ideally suited for measuring progressive phenomena at increasing distance from the point of explosion.

And small but dramatic will be the role played by an AN/CPN-6 Radar Beacon which, carried by the *Saravoga*, will transmit the signals by which the bomb-carrying plane will home on its target.

It is of course self-evident that none of these equipments,—none of these experiments—will be any more successful than the men who install, test, and maintain them. To perform these tasks some five hundred engineers, technicians, and scientists will take part in the operation. The electronics repair ship *Avery Island* will be assigned for the sole purpose of providing the necessary installation, repair, test and technical facilities. In addition this ship will carry the receivers to monitor the equipments which will be operating during the explosion.

A later issue of *ELECTRON* will carry the all-important sequel to this story—what happened when the atomic bomb exploded over Bikini Atoll. In the meantime electronics prepares and rehearses for the part it will play in this great experiment.

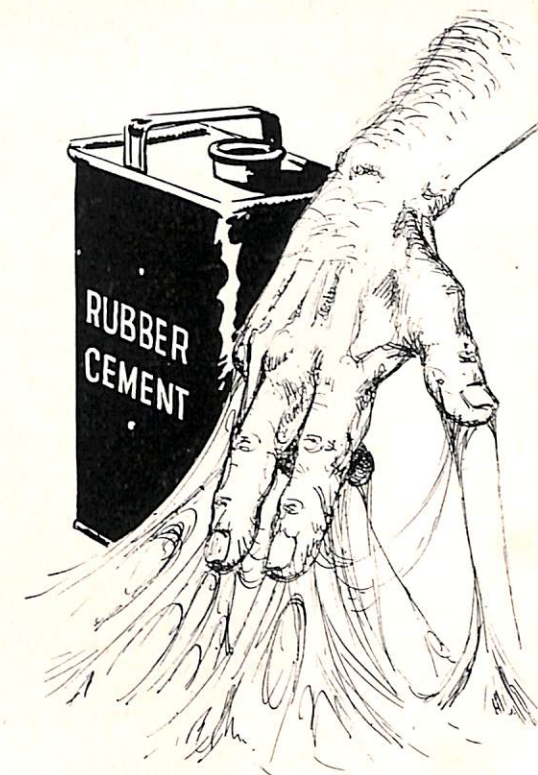

MARK 22 FIELD CHANGE No. 5

Field Change No. 5 provides antenna waveguide horn caps and an application kit to Radar Equipment Mark 22 Vessel Spares, List A.

Included in the application kit is a can of rubber cement which will probably become dry over an extended period of storage. Should this cement harden in the can it is a simple matter to restore it to a usable condition by mixing a small quantity of Solvesso No. 1, which is provided in the kit, with the dry residue in the cement can. The amount of Solvesso No. 1 used is not critical, but only enough should be used to restore the cement to a consistency suitable for the purpose.

The above information also applies to vessel spares List A of Radar Equipment Mark 22, No. 865 to No. 905. This kit was provided in these spares as item 362A.

CLASSIFICATION OF SONAR RECORDER

To avoid any possible misunderstanding the Bureau of Ships re-affirms the security classification of the Sonar Tactical Recorder as RESTRICTED. This classification covers Models CAN-55069, -55070, -55070A, -55070B, -55070C, -55100, -55100A, -55134, -55134A, -55171, and -55181.

Model TDZ Radio Transmitter which, with the Model RDZ radio Receiver, will comprise the prospective VHF shipboard setup.

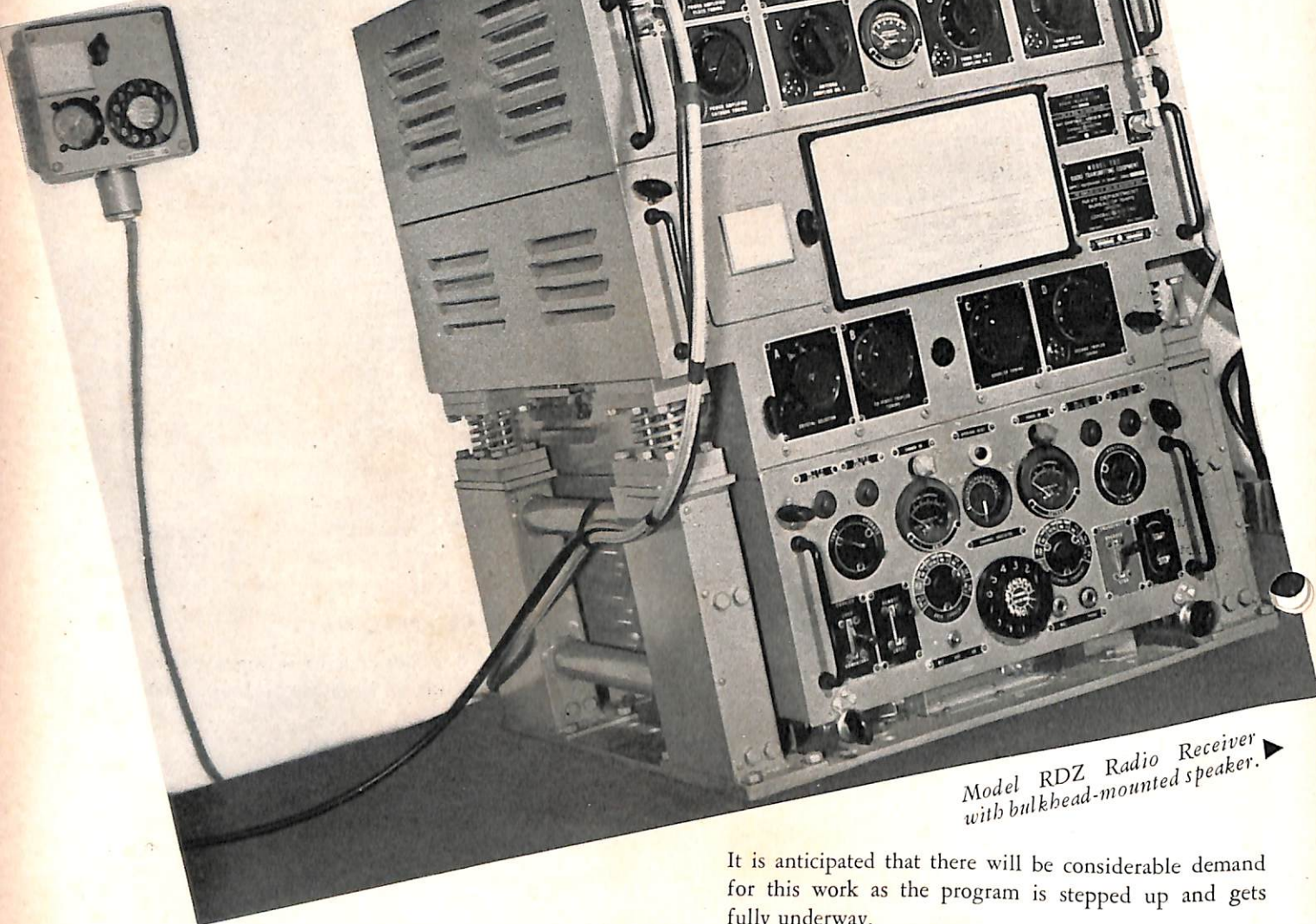

Model RDZ Radio Receiver with bulkhead-mounted speaker.

UHF/VHF Installation Program

By I. BERGSTEIN, Engineer, Bureau of Ships

The August, 1945 ELECTRON contains an article on the UHF communication program, outlining its background and the general categories and application of the various models of equipment involved. The September, 1945 issue contains an article describing the Model RDZ receiver, which is used extensively in this system as a companion to the Model TDZ transmitter.

It is the intention of this article to outline the extent of the installation program involved and how it is to be processed, with special emphasis on installation planning.

It is anticipated that there will be considerable demand for this work as the program is stepped up and gets fully underway.

As a preliminary to the preparation of working installation plans, the Bureau has prepared and distributed systems sketch plans and equipment outline dimensional drawings for use in developing type plans for various classes of vessels. These plans are prepared in such a manner as to enable a shipyard to readily adapt them for use as working installation drawings for a specific vessel by incorporating minor changes, such as the addition of ship name, changes in title block and notes, as appropriate, to conform with local installation practices. These plans also afford the means for making estimates of bulk quantities of installation material such as cable and fittings and taking the necessary steps for providing this material in sufficient quantities well in advance of installation requirements. In general, wiring installation is accomplished in such a manner that "stop-gap" gear can

be installed using the new cabling until the new equipment becomes available. Where practicable, old cable is removed from existing installations and new cable installed in accordance with the ship installation drawings.

Initial installations are of necessity subject to the technical limitations of the first production equipments but will take into consideration the ultimate installation which will provide for completely flexible remote control and channel selection. In general, all multiple installations will provide for suitable switching or patching arrangement to permit utilization of any equipment with any remote control unit. The installation will be designed to conform with damage-control principles which require affective dispersion of equipment and secondary routing of remote control circuits. Insofar as possible, one UHF equipment will be capable of direct control from each of the following stations: primary flag control, primary ship control, secondary flag control, secondary ship control, and CIC.

In order that this program may provide a satisfactory replacement for the stop-gap (AN/ARC, SCR-639/40, TDQ, etc.) equipment now in use, it is of the utmost importance that installation of new equipment as a whole comprise a complete communication system. Because of the tie-up of communication between ships, aircraft and shore stations, each individual unit of equipment must

be completely coordinated with every other unit and the maximum interchangeability of components, maintenance techniques and other factors be effected.

In general, one unit comprising one TDZ and two RDZ equipments or one MAR and one RDR is to be installed in each ship until all ships whose allowance includes this equipment are supplied. At that time multiple installations will be considered.

The following statement of the basic policy of the Bureau of Ships serves as a guide for planning the UHF/VHF communications program for active vessels of the post-war fleet.

The installations will take place in a series of steps, each of which must be completed for all ships before the next step is begun. The installations in each step are to be in accordance with the current allowance in effect at the time. The plan is as follows:

Step 1: First, all vessels are to be brought up to allowance of equipment for the 60-80 Mc (VHF) frequency range. In addition, where space and weight will permit, one unit consisting of a TDZ and two RDZ (UHF) or an MAR/RDR equipment shall be installed.

Step 2: Remove equipment used for the secondary inter-fighter director net and make another UHF installation. The specific model will depend upon the weight and space allocation and equipment availability.

Step 3: Remove screening-type communication circuit equipment and install appropriate UHF units (TDZ/RDZ or MAR/RDR).

Step 4: Remove all 60-80 Mc equipment and install appropriate UHF units.

Step 5: Remove, in steps, heavy-weight VHF equipment and install TDZ/RDZ units up to the full allowance.

It is expected that installation of UHF equipment in submarines will be delayed until about the latter part of 1946 because of the special problems involved. For example, a suitable antenna system capable of withstanding the high pressures, watertightness and depth charges during submergence, is still under development. Also, the size of RDZ-TDZ equipments is such that locations other than the radio room may be necessary at some sacrifice of berthing facilities or other ship's functions. These matters are being carefully studied by the Bureau.

Although the above installation program may appear unnecessarily complicated and involved, it nevertheless represents the minimum in equipment requirements as expressed by the Fleet for both primary and secondary (back-up frequencies) communication circuits. The ultimate goal is to establish the 225 to 400 megacycle band exclusively for short-range communication in fleet, air and amphibious operations.

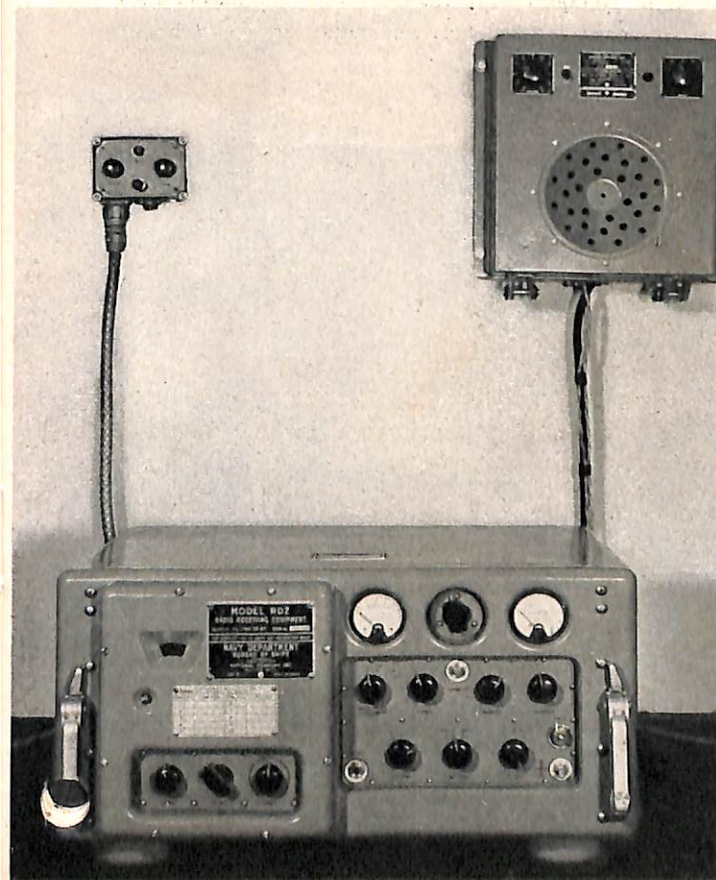

VTVM in Radar Distribution Switchboard

By R. D. CHIPP, Lt. Comdr., USNR, Bureau of Ships.

■ The rapid growth of radar repeater systems aboard combatant ships was anticipated in the early stages of the war. As early as November, 1942 the specifications for trigger and video input voltages to PPI repeaters were standardized by the radar design section of the Bureau of Ships. It is significant to note that in the latest edition of the repeater specifications (dated August, 1945) these same basic voltage standards were maintained, exclusive of refinements permitted by advances in the art.

Present specifications for trigger voltages require that the pulse shall conform to the following: 1—Positive polarity. 2—Duration of not more than 10 microseconds, measured at 85% of nominal peak voltages. 3—A nominal peak voltage of not less than 50 volts, measured across 75 ohms $\pm 5\%$. 4—Rise time within 20% of nominal pulse length, and at no time shall the rate of rise be less than 40 volts per microsecond. 5—Positive and negative overshoot not to exceed 10% of nominal peak voltage.

Specifications for video voltages require that they fulfill the following requirements: 1—Positive polarity. 2—Peak amplitude to be limited to 2 volts ± 0.5 volts measured across 75 ohms $\pm 5\%$. 3—Noise amplitude shall not be less than 0.75 volts r.m.s. under normal operating conditions.

Due to aging of tubes or other causes the trigger and/or video output voltages from master radars frequently fall very close to the outside limits of required specifications, necessitating readjustment of the repeater when it is switched from one master radar to another. For example, the mutual conductance of a 6SN7 tube may vary from 3600 to 2400 micromhos and still remain within specifications. Likewise the mutual conductance of a 6AG7 tube may vary between 14,200 and 9200 micromhos and still be within limits.

In order to minimize these variations and maintain an integrated repeater system as trouble-free as possible, radar distribution switchboards for large combatant ships are designed to have a gain control with sufficient adjustment to permit setting the output of the board at 2 volts with input variations from 1.5 to 2.5 volts. This control is a screwdriver potentiometer located on the front of each video driver on the switchboard.

For measuring the input and output voltages of a switchboard there is incorporated in the unit a peak-reading vacuum-tube voltmeter. The output to each video driver should be checked once every 24 hours. Should the input voltage be less than 1.5 volts the master radar and/or coaxial cable between radar and switchboard

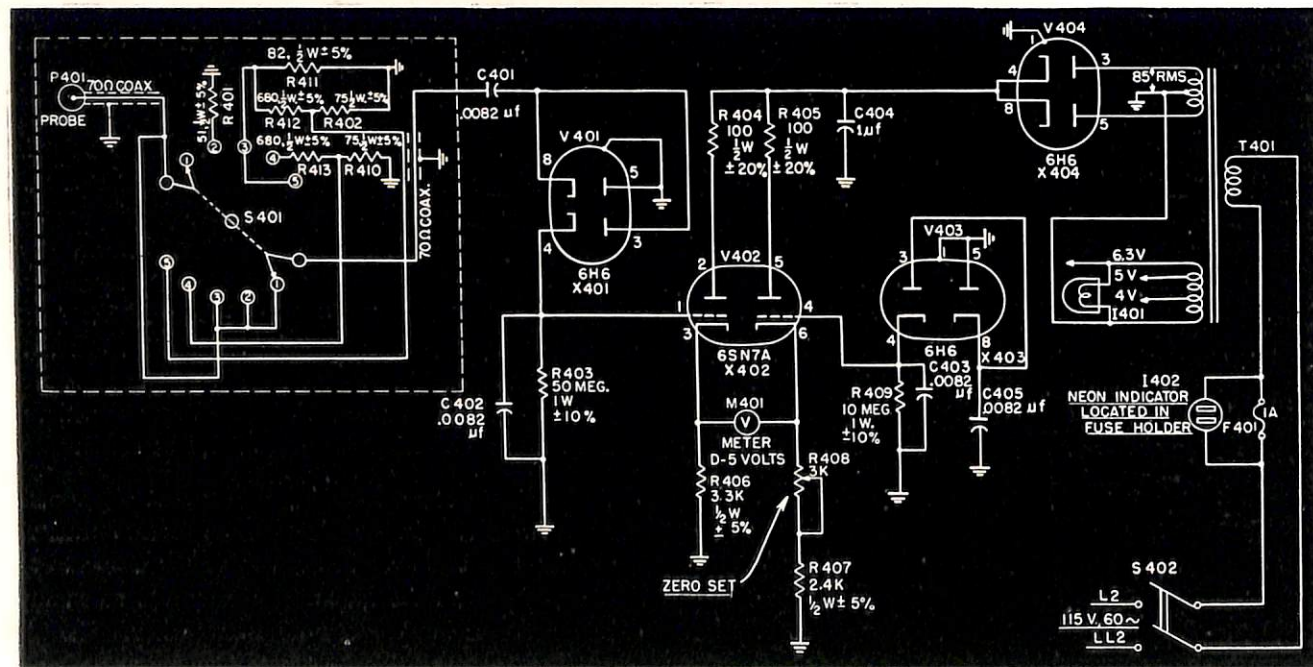

Schematic diagram of the Vacuum-Tube Voltmeter used in the CM-23AGU Radar Distribution Switchboard. Portion enclosed in dotted lines is added to CM-23AFL as a part of Field Change No. 1.

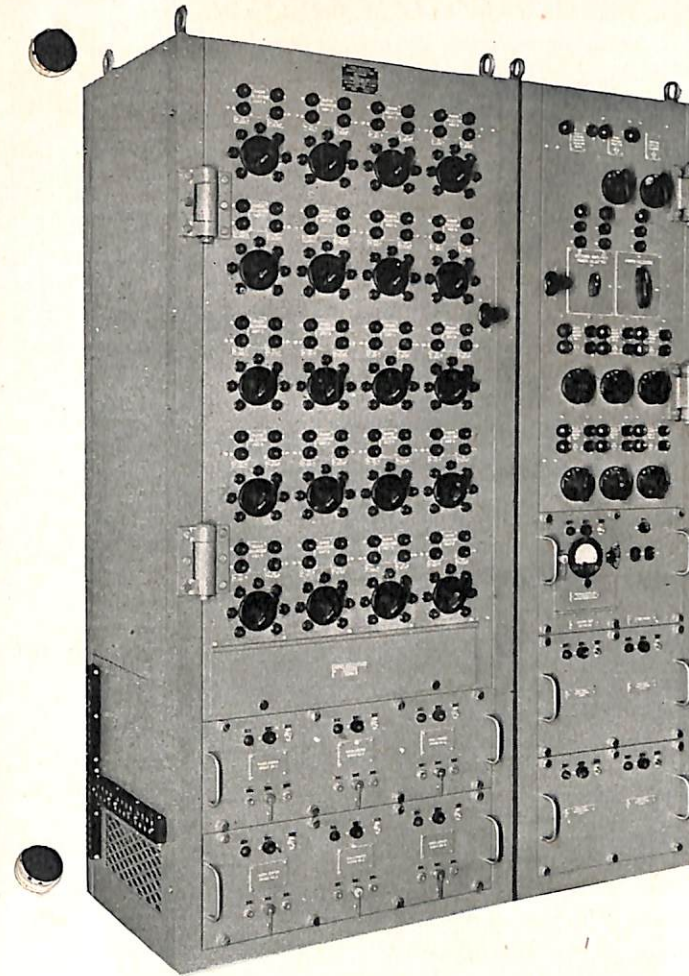

Navy Type CM-23AGU Radar Distribution Switchboard showing new type Vacuum-Tube Voltmeter and Multi-Position Switch.

Navy Type CM-23AFL Radar Distribution Switchboard with old-type unmodified vacuum-tube voltmeter using two-position termination switch.

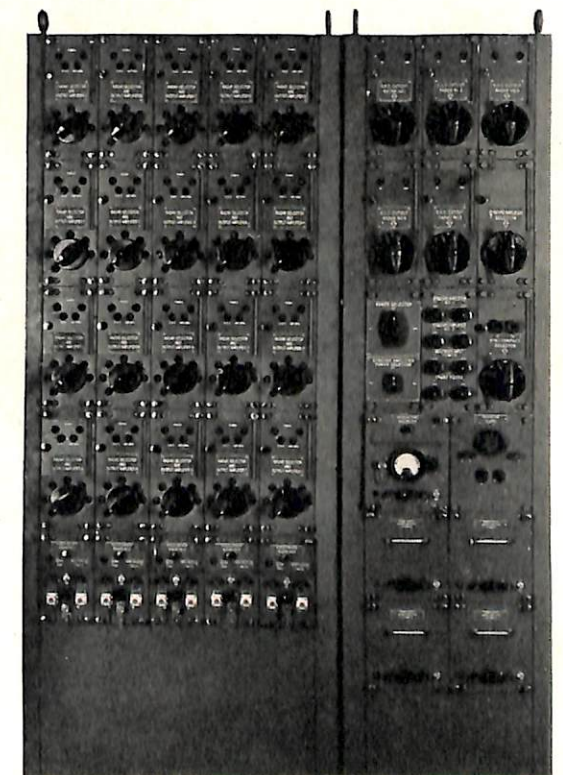

should be checked. If the input falls within the 1.5- to 2.5-volt limit, the gain control in the video driver should be adjusted so that the output is 4 volts, since this driver feeds a cathode follower where the signal loses half of its amplitude, thus furnishing a 2-volt output from the cathode follower to each repeater.

The first model of the Type CM-23AFL Radar Distribution Switchboard was equipped with a vacuum-tube voltmeter capable of measuring video voltages only. In the second model, Type CM-23AGU, a vacuum-tube voltmeter with a probe and an additional 0-50 volt scale was added which permits measuring either trigger or video voltages at any point within the switchboard, thus contributing to the flexibility of this piece of test equipment. Terminations for 50- and 75-ohm inputs are provided, plus a high-impedance input for measurement of lines already terminated. The technician should bear in mind that under normal operating conditions the video and trigger cables are terminated, and measurements should be made with the VTVM switch in the high-impedance position.

Field Change No. 1 to Type CM-23AFL Radar Distribution Switchboard is a modification of the vacuum-tube voltmeter circuit, making it comparable to the voltmeter circuit and applications in the CM-23AGU. On the new CM-23AGU switchboard, and after Field Change No. 1 has been made on the old type, the actual output voltage of the cathode follower should be checked rather than the output of the driver. This is feasible due to substituting the probe for the coaxial plug originally furnished with CM-23AFL.

Using the above procedure it is possible to set up the entire radar system on a ship so that the repeaters may be switched at random without necessitating individual gain readjustment. It should be noted that the vacuum-tube voltmeter reading requires correction only if the duty cycle is very low. Table I shows the duty cycles and corrections for certain radars now in use in the fleet.

TABLE I—Correction to be applied to vacuum-tube voltmeter readings when used with certain radars. Figures based on Radiation Lab (MIT) curves shown in RDS instruction book.

Radar	Rep. Rate	Pulse Width	Rep. Rate Times Pulse Width (Duty Cycle)	Multiply Reading By
SC/SK	60	5	.0003	1.26
SG	800	2	.0016	1.07
SG $\frac{3}{4}$	750	.33	.00025	1.31
		1.25	.00024	1.11
SM	800	1	.0008	1.12
SP	600	1	.0006	1.16
		5		
SR	120	4	.00048	1.18
SR-2	600	1	.0006	1.15
		4	.00072	1.14
SX	390	1	.00039	1.22
		1170	1	.0012

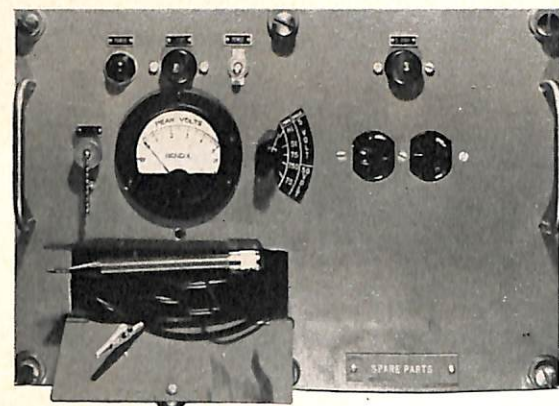

Front view of voltmeter unit employed in type CM-23AGU Switchboard. Note "Spare Parts" tag in lower right-hand corner.

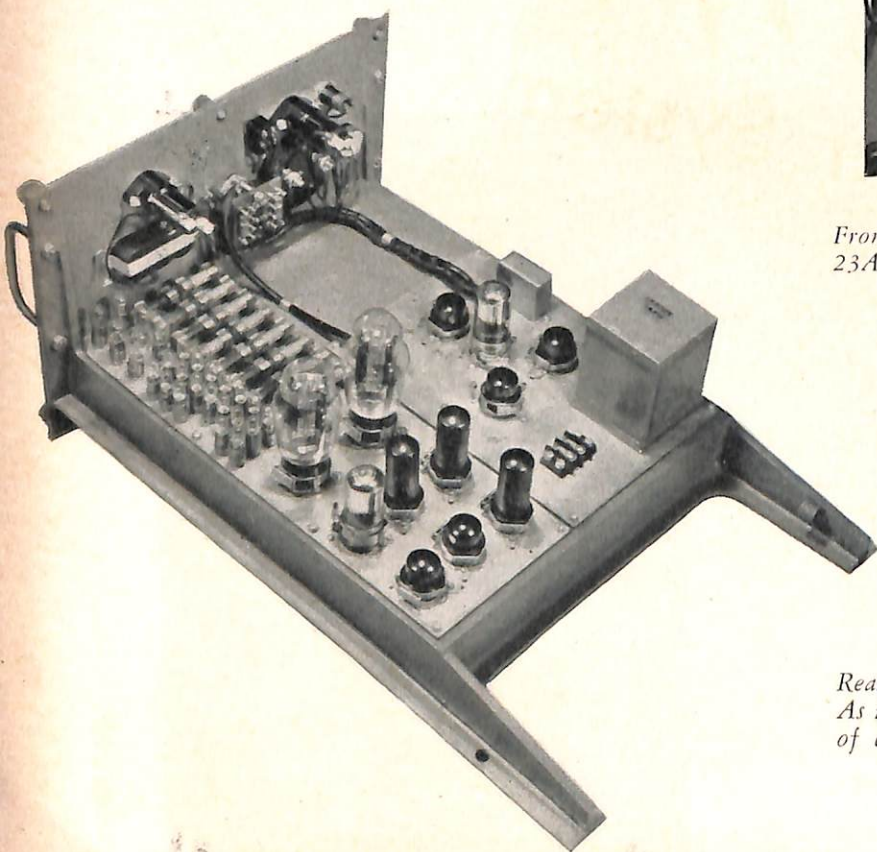

Rear view of voltmeter unit used in the CM-23AGU. As indicated from label on front, all components to left of center (looking from rear) are spare parts. Tube sockets are dummies and all tubes are spares.

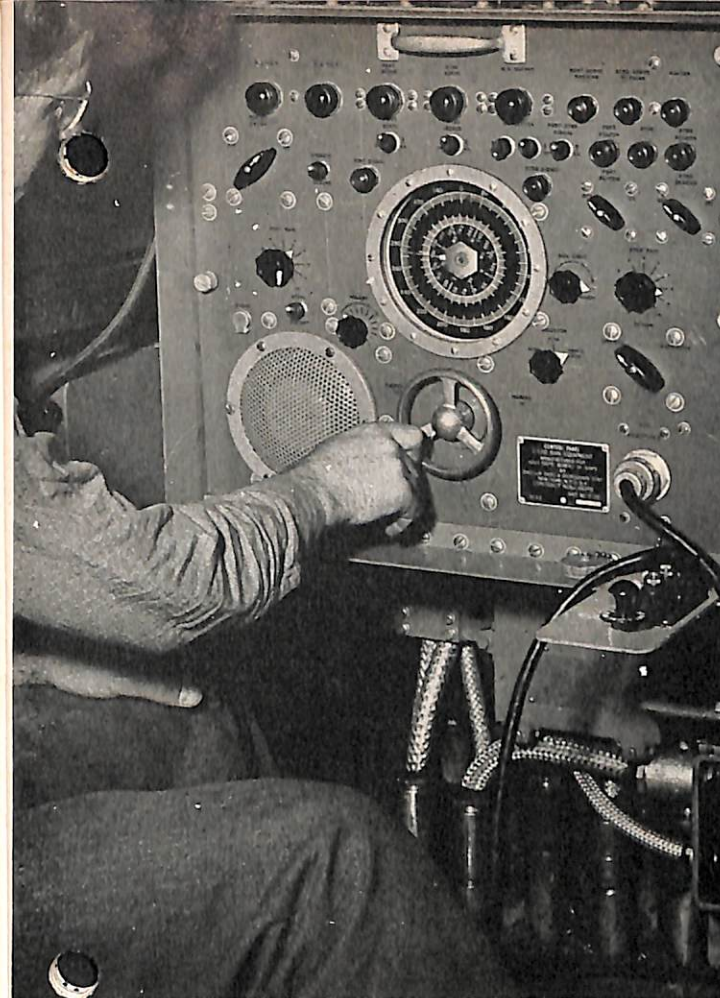

Control panel of the Type-D Nancy Communication System showing the arrangement of controls and switches. Note the scanning control, telegraph key, and bearing indicator. The control panel is located in an enclosed location near the signal bridge.

In order to allow the receivers to be directed at a distant transmitter, a servo system is incorporated. This permits the operator at the control panel to cause the receivers to scan the horizon. This servo system is tied in with the ship's compass so that the relative and true bearings of the transmitter are indicated to the operator at all times, and so that the receivers automatically correct for changes in their own ship's course. A gyro stabilizer is installed in each receiver to keep its reflector pointing at the horizon regardless of the ship's roll.

TRANSMITTING CIRCUITS

The input to the power supply unit is 115-volt, 60-cycle, 3-phase, a.c. Three 2050 thyratrons in the 180-cycle rectifier circuit convert this to 180-cycle pulsating d-c voltage. Every other pulse of this voltage is used to trigger a 2050 thyatron relaxation oscillator which discharges a capacitor that has been charged by the 6X5-GT/G bias tube, thus producing a 90-cycle pulsating d-c voltage.

The Type-D Communication

NANCY

System

■ The Type-D Nancy Communication System provides line-of-sight code communication between ships through the use of invisible infrared radiations. The Type-D system is limited in range by haze, fog, smoke, rain, etc., just as is any other light-communication system. In normal clear weather, communication at twenty words per minute can be maintained at ranges up to about six miles.

The transmitting system consists of a power supply unit and eight transmitting beacons. The receiving system consists of two special photocells, two preamplifiers, switches, a main amplifier, a 1000-cycle oscillator, and headphones and a speaker.

A Type-D Nancy Communication System receiver with its hood removed, showing the general construction of the unit.

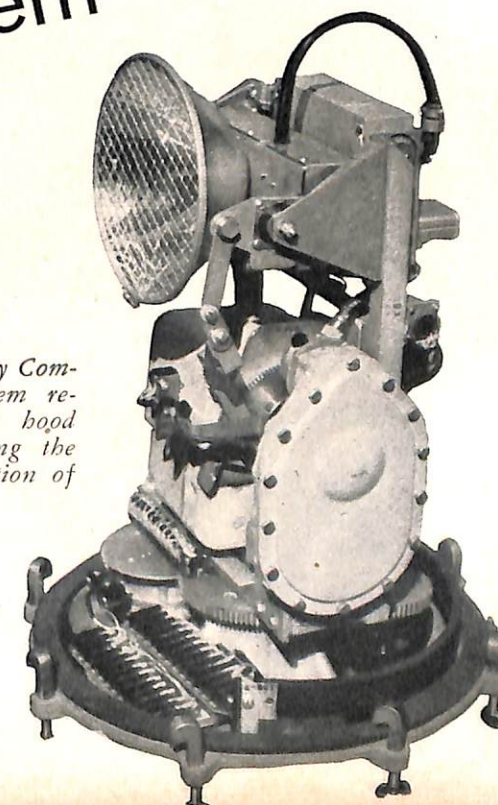

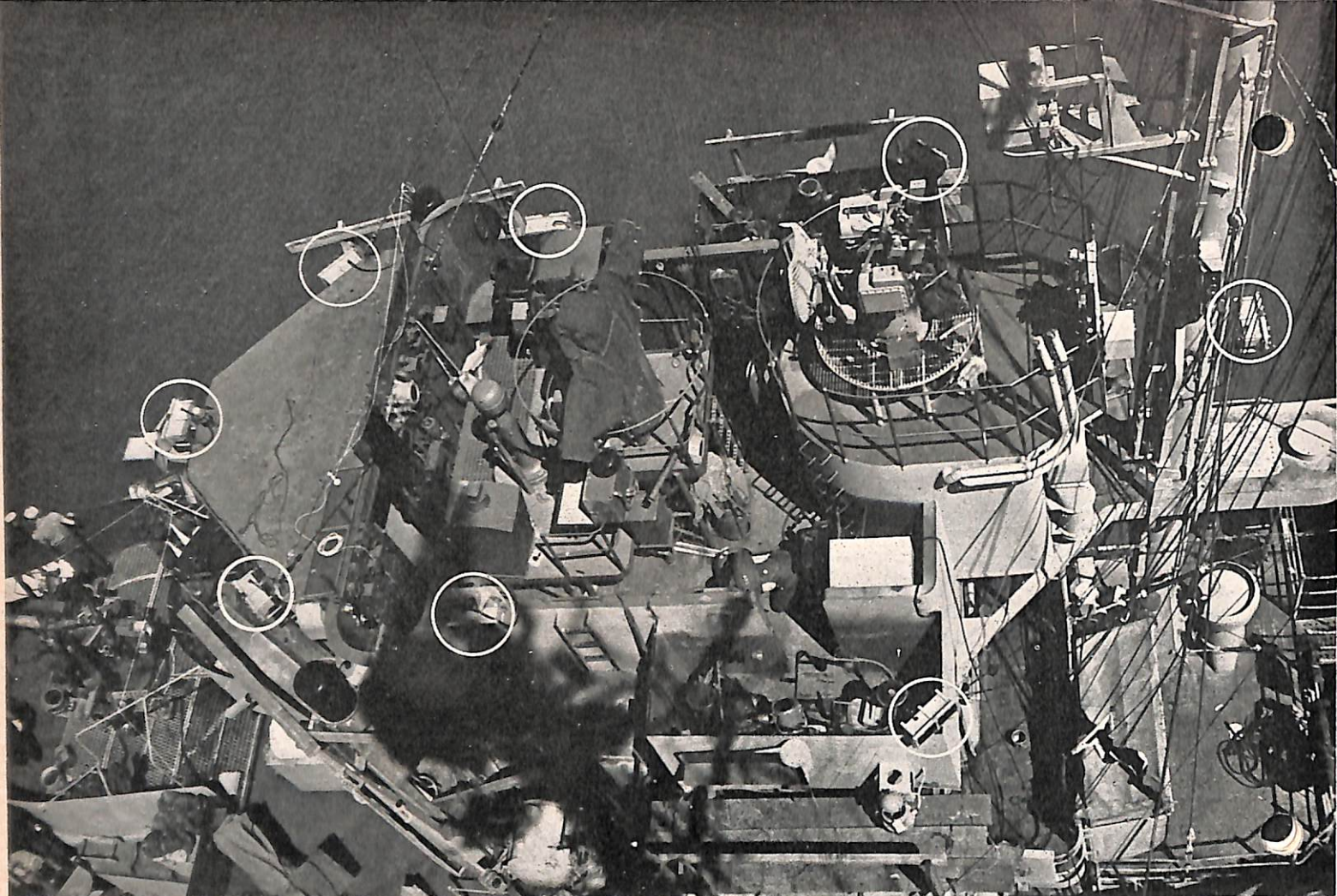

Superstructure of a DE showing the location of the two receivers and eight transmitting beacons of the Type-D Nancy System.

This 90-cycle voltage is used to trigger three FG-172 thyratrons in the load rectifier circuit. The output of the load rectifiers is 90-cycle pulsating direct current which is used to feed the eight transmitting beacons. Keying is accomplished by breaking the 90-cycle pulsating d-c voltage output of the relaxation oscillator.

The eight transmitting beacons are mounted facing 45 degrees apart and are fed in parallel so that, combined, they cover all 360 degrees of azimuth. Each beacon consists of fifteen 10-watt tungsten lamps which are specially constructed to flash 90 times per second in response to the output of the power supply unit. The light from the beacons is filtered by infrared glass filters.

RECEIVING CIRCUITS

The two receivers are mounted on opposite sides of the ship so that they may cover the complete azimuth circle. In each receiver the incoming infrared beam is gathered by a reflector and focused on a photocell. The current through the photocell varies with the intensity

of the impinging infrared beam of light, so that a keyed 90-cycle alternating current is superimposed on the d-c current through the photocell's load resistor. This a-c signal is amplified in a preamplifier and fed to the main amplifier in the control panel.

In the main amplifier, the input from each preamplifier is passed through an amplifier-limiter (V-5 or V-14) and tuned band-rejection filter which introduces negative feedback into the amplifier to attenuate all frequencies except 90 cycles. The output of V-5 and V-14 is amplified and fed to a LOCAL-DISTANT switch. On a weak signal, the amplified output of V-5 or V-14 is connected directly to the power amplifier V-9 and appears in the speaker or phones as a 90-cycle tone. On a strong local signal, the amplified output of V-5 or V-14 is rectified and used as bias to make buffer tube V-8 conduct when the signal is present and cut off when the signal is off. Since a 1000-cycle oscillator is connected to the buffer tube, the output of the receiver, in this case, is a 1000-cycle tone, which can be more accurately copied than the 90-cycle signal.

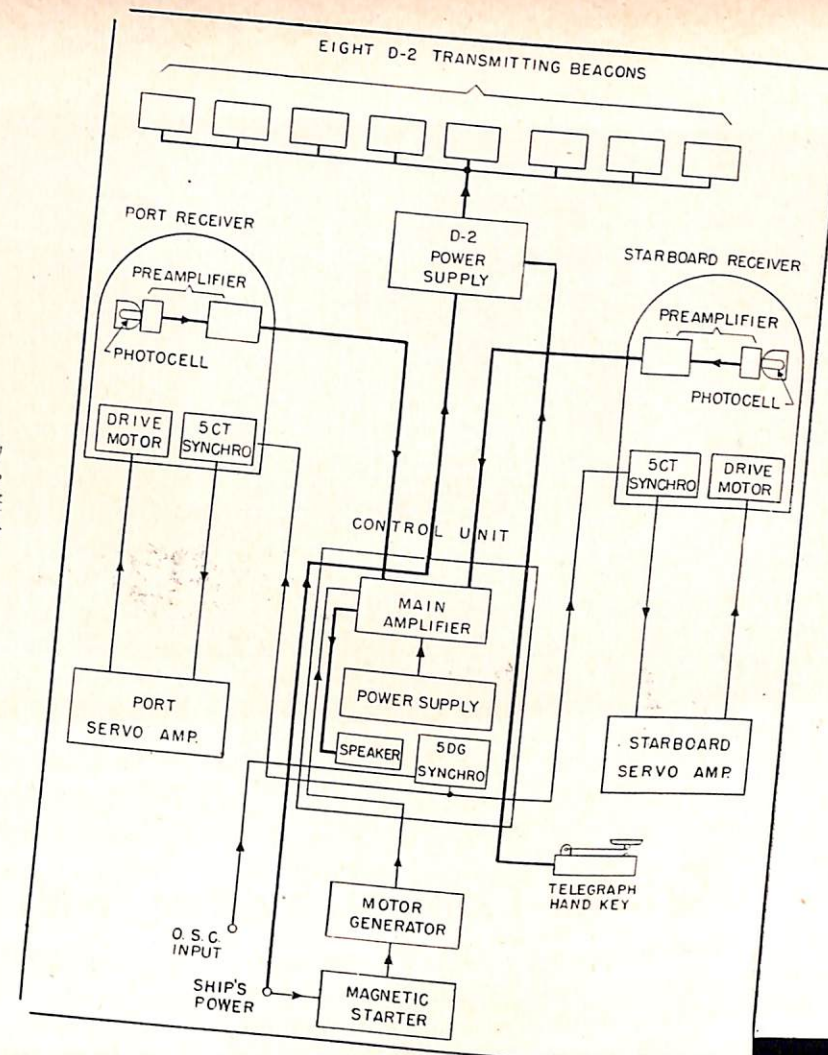

Block diagram of the Type-D Nancy Communication System showing the arrangement and interconnections of major components. The signal circuits are shown by heavy lines.

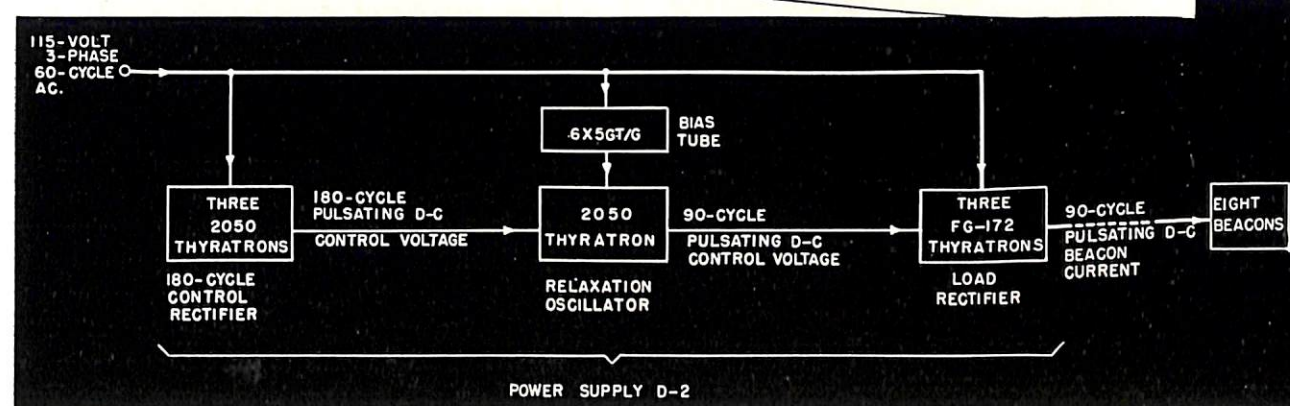

Block diagram of the Type-D Nancy Communication System transmitting circuits showing the path of the signal from ship's power to the transmitting beacons. The signal circuits are shown by heavy lines.

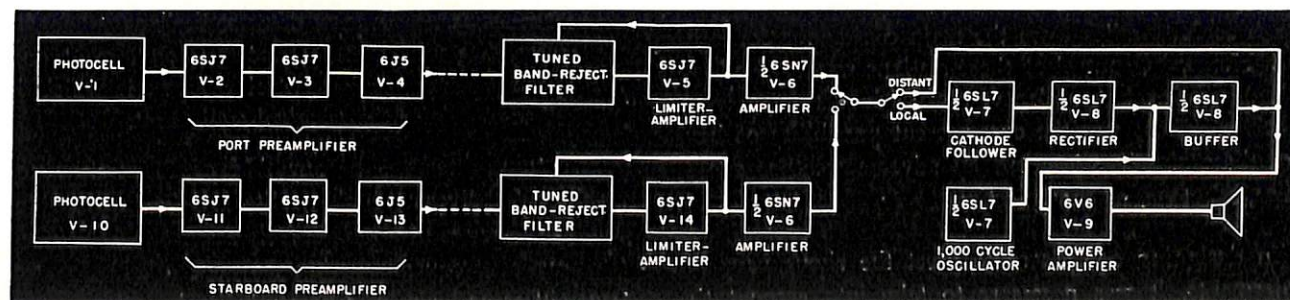

Block diagram of the Type-D Nancy Communication System receiving circuits showing the path of the signal from either photocell to the loudspeaker.

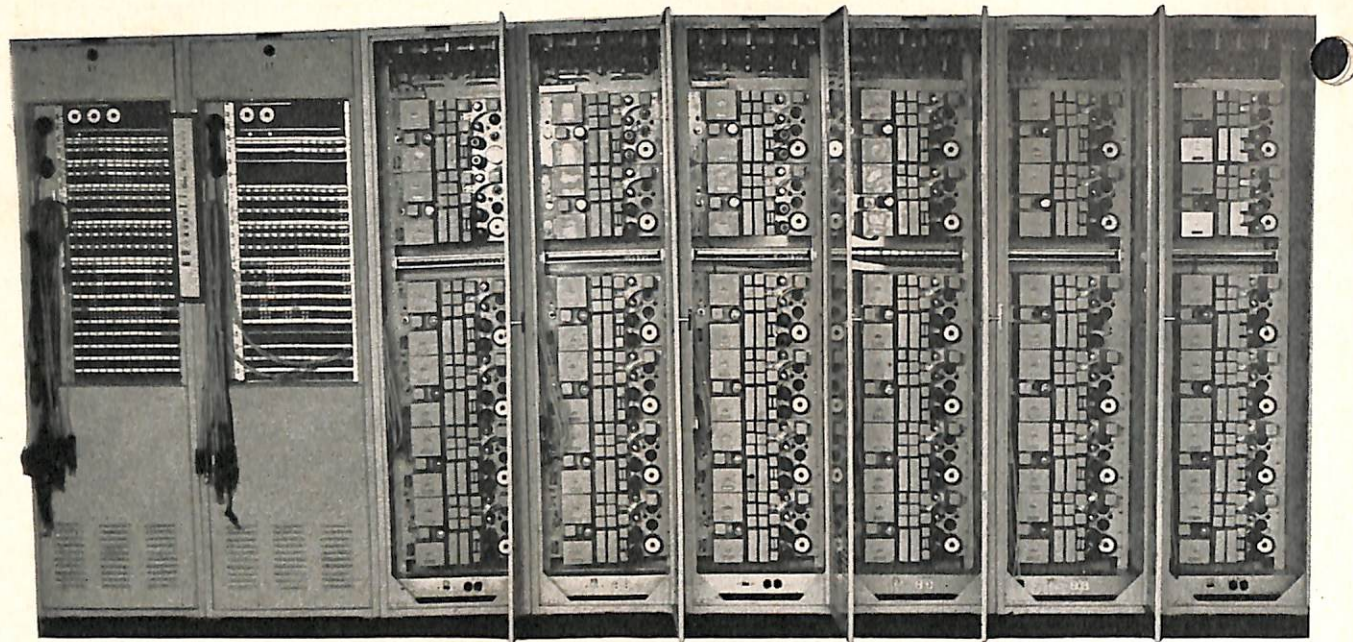

Typical shore station installation of Modulator and De-Modulator Bays used with Model UN Carrier Control Link equipment.

Carrier-Control System with VHF Radio

■ 35 to 50 thousand messages a day in one communication station! This figure will be doubted by many of the old-timers and countless numbers of the newcomers to our Navy Communications organization. Time was when 50,000 words a day was considered a heavy day in any one station. With the advent of war, communication facilities were heavily overloaded and it became imperative that new methods of control be developed and rushed into action to meet this increased load. The system decided upon was an improved type of radio-telegraph multi-channel carrier-control system that would operate several navy radio communication circuits employing teletypewriters or Boehme keyers and recorders over one VHF radio circuit. The equipment was first destined for major naval communication centers to control radio equipment at the transmitting station for an outgoing path, and to handle several circuits from the receiving station for the incoming path. The transmitting and receiving stations are frequently separated by as much as forty miles from the main communication center. Normally, control of these stations was by overland wire facilities, but under war conditions this was not feasible. There was the ever-present possibility of having these circuits disrupted by adverse weather conditions, sabotage, or enemy action.

In designing equipment to meet the above navy requirements, it was necessary to take into account the distinct functional nature of the equipment; namely, an

appropriate VHF transmitter, VHF receiver, and voice-frequency carrier-telegraph equipment. The technique of operating many circuits of telegraph, teletype, and telephone channels over a single pair of wires has long been in use by the commercial companies, and therefore similar equipment was used in applying the system to VHF radio.

As originally set up, these systems were designated "Carrier-Control System, Navy Model UN". Many improvements have been made since the early development and, in addition, the Navy is now utilizing the system to perform several functions. That is, they are used to remotely "key" transmitters, to remotely "repeat" CW, teletype, or multiplex signals received over a radio circuit, to operate keyer or recorder equipment over VHF radio, to operate teletype or telegraph equipment over VHF radio, and to operate voice order-wire channels simultaneously with the teletype and telegraph channels. The complete system consists of three basic components: the transmitting equipment, the receiving equipment, and the voice-frequency carrier-control equipment which is referred to simply as the terminal equipment.

The transmitter can be any AM or FM transmitter capable of delivering high quality and having a wide-band audio range of approximately 200 to 10,500 cycles. The carrier frequency assignment authorized for the transmitters and receivers presently used in this system provides a number of channels between 132 and 156 Mc.

The transmitter that was developed with the above characteristics is the Navy Model TDG. This transmitter is crystal-controlled, uses amplitude modulation and is adjustable (by changing crystals) over the entire band of 132 to 156 Mc.

A crystal-controlled superheterodyne-type receiver was developed and assigned Navy Model RBQ. It is adjustable over the entire range from 132 to 156 Mc. This receiver also has a self-contained, crystal-controlled test oscillator used for lining up the receiver.

Both the transmitting and receiving equipments may be used with several different interchangeable types of antennas, depending upon transmission requirements. Three types of antennas are available for the TDG and RBQ equipments, consisting of a high-gain (9 db) multi-element, a medium-gain (6 db), and a low-gain (3 db) unit. Solid-dielectric or gas-filled coaxial transmission lines may be used in connection with the above antennas.

The terminal equipment is the heart of the Model UN carrier control system. It is a multi-channel voice-frequency carrier-telegraph system used primarily to provide

telegraph communication over a short radio link at very high frequency (132 to 156 Mc). The system operates on an equivalent 4-wire basis; that is, each channel is a one-way circuit. For two-way communication between two points, two channels (one for sending and one for receiving) are necessary, thus involving two radio links. The system may be operated over a 4-wire telephone line capable of transmitting frequencies from 200-10500 cycles. The carrier-telegraph system transmits both upper and lower side-bands of the modulated carrier. A number of different combinations of telegraph and telephone facilities may be employed and they may be divided into two general classes—one without H1 carrier-telephone equipment, and one with this equipment.

A maximum of fifteen voice-frequency carrier-telegraph channels, twelve narrow-band and three wide-band, or one voice channel and three wide-band channels may be obtained without the H1 carrier-telephone equipment. With the H1 carrier-telephone equipment, three separate voice circuits may be obtained, the normal voice channel and two carrier channels. Each of these circuits may be used for one, three, or twelve narrow-band voice-frequency telegraph systems. The term "voice-frequency" may be defined as covering a band from 200 to approxi-

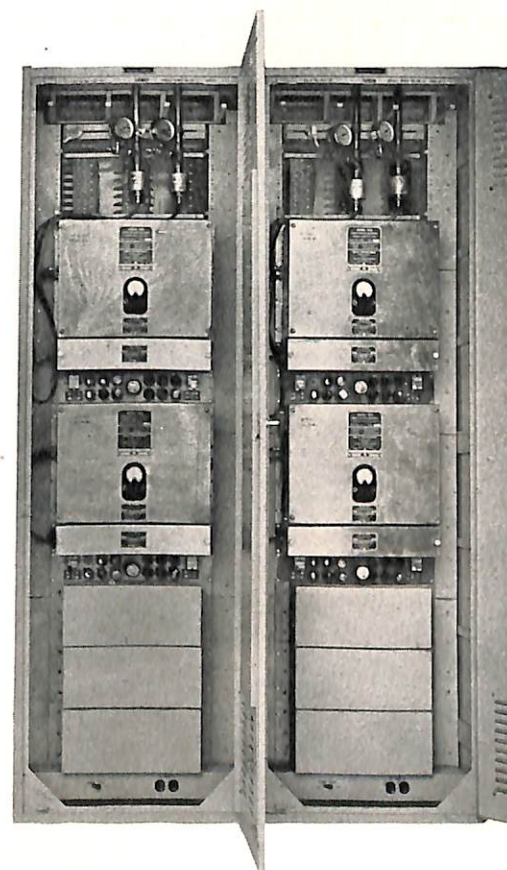

TDG transmitter used with Navy Model UN Carrier Control Link equipment.

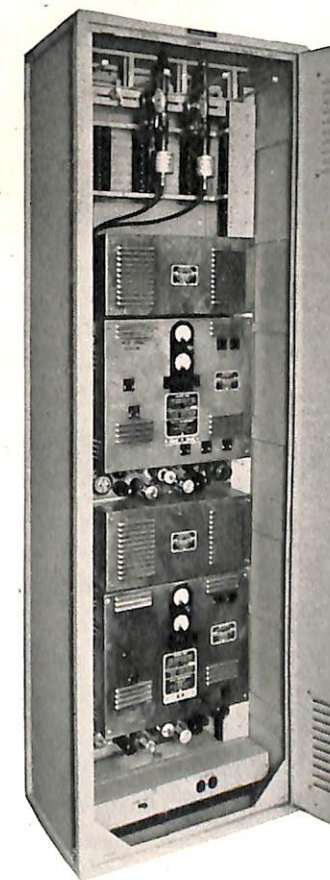

RBQ receivers used with Model UN Carrier Control Link equipment.

2—Twelve narrow-band voice-frequency carrier-telegraph channels as in (1), and in addition three side-band carrier-telegraph channels using frequencies of 2975, 3825, and 4675 cycles.

3—Three narrow-band voice-frequency carrier-telegraph channels using frequencies of 425, 765, and 1105 cycles. These channels employ the regular narrow-band sending and receiving filters, thus furnishing only narrow-band telegraph channels even though the carrier frequencies are fairly widely spaced.

4—One voice-frequency carrier-telegraph channel with a carrier frequency of 425 cycles but without sending and receiving filters, thus providing a fairly wide-band channel.

5—One voice-frequency telephone channel with a restricted range (about 300 to 2500 cycles) and three wide-band telegraph channels.

6—Three voice circuits as follows: No. 1 voice circuit, voice-frequency telephone. No. 2 voice circuit, a carrier-telephone channel using frequencies from about 4150 to 6900 cycles. No. 3 voice circuit, a second carrier-telephone channel using frequencies from about 7400 to 10,150 cycles.

7—One voice-frequency telephone channel without provision for any carrier-telephone or any carrier-telegraph channels.

In addition to the seven combinations operating directly over the radio link, as listed above, it is also possible to operate, as indicated on the chart, any one of the narrow-band voice-frequency telegraph systems (single-, 3-, or 12-channel) over any one or all three voice channels provided in (6) above.

At the sending end twelve narrow-band voice-frequency carrier-telegraph channels, 170 cycles apart, are assigned to frequencies from 425 to 2295 cycles. After modulation by the telegraph signals, these frequencies are passed through their respective sending filters to a send bus, to the low-pass section of the line filter, and to a line amplifier. They are then used for direct modulation of the radio carrier. The three wide-band telegraph channels having carrier frequencies of 2975 cycles are interrupted or modulated by the telegraph signals from the keying circuits, passed through sending filters, a high-pass line filter which passes frequencies above about 2600 cycles, and after amplification are used for direct modulation of the radio carrier. The twelve narrow-band telegraph group may be replaced by a single voice-telephone channel. For this case, the telephone frequencies, after passing through a volume limiter, a low-pass filter with an upper limit of about 2500 cycles, and a line amplifier with a lower limit of about 300

cycles, are used for direct modulation of the radio carrier.

At the receiving end, the twelve voice-frequency carrier-telegraph currents pass through the low-pass section of the line filter and a line amplifier to the twelve telegraph receiving circuits. The receiving filters pass each respective channel frequency and exclude all others, and this current is demodulated and passed to the telegraph recorders. In case a voice channel is used, the telephone currents pass through the low-pass section of the line filter, a line amplifier, and to the telephone receiver. The three wide-band frequencies of 2975, 3825, and 4675 cycles pass through the high-pass section of the line filter and, after amplification, are separated by the receiving filters and demodulated as in the case of the twelve narrow-band frequencies.

Figure 2 illustrates how the band of available modulating frequencies from approximately 100 to 10,300 cycles, transmitted over the radio link, may be split into three voice channels by means of the H1 Carrier-Telephone Equipment. For reasons of simplicity, the transmitting branches of two H1 carrier-telephone terminals are shown at the left and the receiving branches at the right. The lower frequency limit of all voice channels is about 300 cycles. The upper frequency limit varies depending upon whether or not the channels are obtained from the carrier-telephone system. However, as a round figure, 3000 cycles has been indicated as the upper limit.

When sending over the H1 equipment, the voice frequencies in voice circuit No. 1 (approximately 300 to 3000 cycles) are used for direct modulation of the radio carrier. In voice circuit No. 2 the voice frequencies modulate a 7150-cycle carrier, and the lower side-band, from approximately a 4150 to 6900 cycles, is used to modulate the radio carrier. In voice circuit No. 3 the voice frequencies modulate the same carrier of 7150 cycles, and the upper side band, from approximately 7400 to 10,150 cycles, is used to modulate the radio carrier. The upper and lower sidebands of the two carrier telephone channels are separated by the band filters and the carrier-telephone frequencies are separated from the voice frequencies by the high-pass and low-pass sections of the line filters.

At the receiving end, the low-pass section of the line filter separates all frequencies below about 3300 cycles from the higher frequencies, and these lower frequencies are then passed to the voice-frequency telephone receiving circuit. The high-pass line filter passes all frequencies above approximately 3700 cycles which include both sidebands of the carrier telephone. These sidebands are separated by the band filters, demodulated, using a 7150 cycle oscillator, and the resulting voice frequencies passed to their respective circuits No. 2 and No. 3.

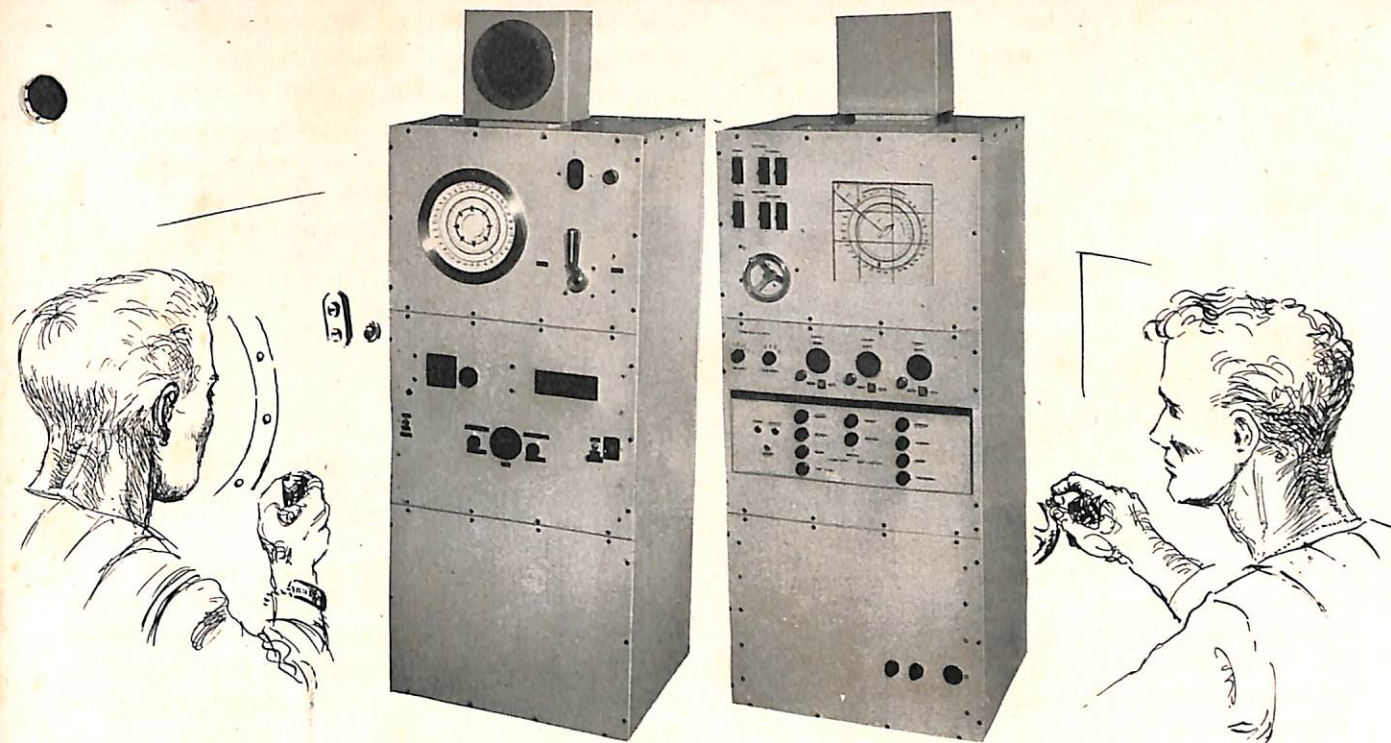

Front panel (student's side) of the advanced listening teacher simulates actual shipboard sonar installation.

Rear view (instructor's side) of QFN shows controls for setting up and controlling problems for training.

The Model QFN Advanced Listening Teacher

■ The Model QFN Advanced Listening Teacher is a new training device, intended for use aboard tenders or ashore for basic training of sonar operators in the operational and tactical use of submarine listening gear, as well as for refreshing experienced sonar operators. The equipment is designed to improve the aural acuity of the operator by presenting more than one target without visual aid (the BDI meter). The device is extremely flexible as a problem generator and simulator. A set of controls on the instructor's panel permits an infinite number of problem setups and changes.

A recommended training procedure is to place one operator at the instructor's panel and another at the student's panel, and interchange their positions periodically. The operator at the instructor's panel would have a visual picture of the actual setup of the problem, which would aid him in forming a mental picture of the situation when he has listening facilities only. This method would permit the operators to set up progressively more difficult problems for each other, and would aid them in picturing more complex situations only by listening to

the sounds available. A detailed description of the controls and functions of the training device will illustrate its many possibilities.

THE STUDENT'S PANEL

The student's panel is the functional equivalent of the listening gear aboard a submarine. Controls are provided for training the hydrophone at speeds from 0 to 5 rpm, tuning the receiver, adjusting the gain of the receiver, and selection of filters.

In addition, the panel contains the usual bearing indicator that shows the student's own ship's heading, and true and relative bearings to which the hydrophone is pointed. The machine presents sounds to the student which stimulate those of his own ship when submerged and underway, and also the propeller beats and echoing pings of two simulated target ships on the surface. The operator identifies, locates and tracks these targets just as he would real targets, while the problem is controlled from the instructor's panel on the opposite side of the machine.

INSTRUCTOR'S PANEL

The instructor's panel is provided with such controls as: switches for quickly positioning the two target ships with respect to the student's own ship, conning selector switches, course and speed (0 to 24 knots) controls for the target ships, course and speed (0 to 12 knots) controls for student's ship, handwheel to rotate bearing line and range scale on viewing screen for laying off bearings and ranges of target ships, controls for echo ranging and sound effects for the target ships, and controls for student's own-ship's sound effects.

The speed and course controls are labeled "Conning A", "Own Ship", and "Conning B". The speeds are indicated in knots on counters near the controls, and the courses are indicated by miniature gyro repeater cards, also near their respective controls. At the upper left are the two conning selector switches which, for normal control, should be in the down position to put the red target on Conning A and the blue target on Conning B. For convoy problems both targets can be connected to the same conn (A or B) so that they move together; and when the convoy is zig-zagging, Conning A and Conning B can be set for alternate legs of the course, so that the swing from the right to the left leg, for example, can be made by merely flipping both conning selectors from A to B. However, the speed of the propeller beat for the red target is always governed by the "A" control, and that of the blue target by the "B" control. Consequently, in convoy problems, it is advisable to take care to keep the "A" and "B" speeds alike, in which case the idle course control is disregarded.

The four switches to the right of the two conning selectors are for quickly positioning the red and the blue targets on the viewing screen when setting up the equipment at the beginning of a problem.

The instructor's viewing screen depicts an ocean area 8000 yards square, centered on the student's own ship. This screen is stationary with North indicated at the top so that true bearings may be read on a stationary outer scale. A bug ring just inside the true-bearing scale indicates the bearing to which the student's hydrophone is pointed. A central card rotates to show the heading of the student's ship, as set by the instructor's conning control, and therefore carries the relative-bearing scale. Two pairs of crossed colored lines indicate the positions and motions of the two targets on this screen, the intersection of the red pair showing the location of the red target, and that of the blue pair the blue target. Their positions and motions are, of course, shown relative to the student's own ship, so that, for example, when the two targets and the student's own ship all are set at the same course and speed, the targets remain stationary on this screen. These four red and blue target lines are carried on four separate transparent strips, each of which de-

picts the relative east-west and north-south movement of a target relative to the student's own ship in accordance with the speed and course settings of the three ships.

The front transparency of this indicator carries an engraved bearing line and range scale that extends radially from the center of the indicator (center of student's ship) for use by the instructor in laying off the bearings and ranges of the targets. The whole transparency can be rotated by a hand wheel at the lower left of the screen for lining it up with a target, and ranges may be read off the scale. Though not specifically intended for the purpose, it can also be used to estimate the course of a target relative to the student's ship. To do so, the instructor should note the direction of motion of the target across the screen, and turn the transparency to bring the engraved line parallel to this direction of motion. Relative course can then be read from the bearing scales. True course of the target does not appear on the screen, but may be read from the gyro compass card at the conning control.

To the left of the conning controls are two knobs for selecting the type of propeller beat. Five types are provided for each target.

OWN-SHIP'S SOUNDS

The machine generates both the rushing sound characteristic of own-ship's water noise, and a modulation of this rushing sound which constitutes the propeller noise. Both of these sounds become louder as the student trains his hydrophone aft, and as the speed of the student's own ship increases. The propeller speed (the frequency of the beats) increases with ship's speed, and the "definition" of the screw noise, that is, the degree to which the propeller beats stand out from the water noise, drops off at high speed.

All of these effects duplicate actual sea sounds, and they are controlled by the two knobs located on the instructor's side just below the "own ship" conning control. The "definition" control, when turned to the left, reduces the distinguishability of the propeller beats. The "intensity" control varies the loudness of all of these water noises and propeller effects. These two controls are intended to be set to near maximum for reproducing ordinary sea conditions under which listening is satisfactory but noisy at six knots, and impossible at nine knots.

TARGET SOUNDS

Water and propeller noises from a target can be heard when the student's hydrophone faces it. The apparent angular width of the target is substantially constant, except that it widens at ranges below 500 yards. The sounds undergo selective attenuation as the hydrophone

Simplified block diagram of QFN Advanced Listening Sonar Teacher.

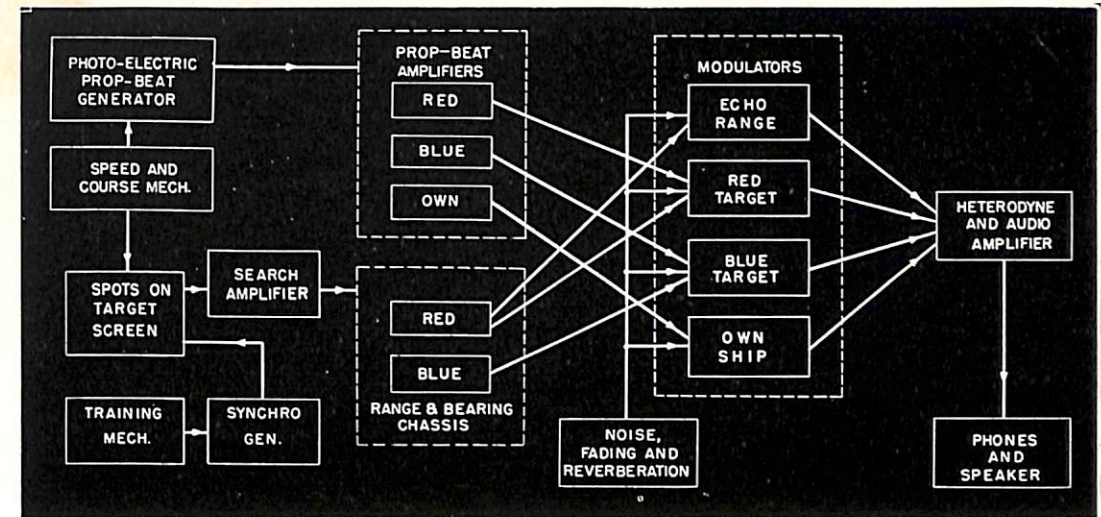

swings off the edge of the target, and they get louder as the range shortens. The propeller speed matches the speed of the ship as set by the conning control, and the definition of the propeller beat decreases at high speed. The type of propeller sound (and therefore its rpm/knot) is determined by the "Screw Noise Selector" located to the left of the conning controls. The speed of the propeller beat of the red target is always controlled by "Conning A" and that of the blue by "Conning B". These target sounds also undergo a selective change and an apparent change of target angle characteristic of actual sea sounds as the student adjusts his tuning dial.

These water noise and propeller sounds will fade in and out slowly but irregularly (accompanied by selective effects), but this fading can be reduced or eliminated by means of the "fading control (red and blue as shown in the figure). The "definition" control (red and blue) for the target governs the definition of the propeller beats just as in the case of the student's own ship. The "intensity" control (red and blue) governs the intensity of all these water and propeller noise effects of the target.

Each target is also provided with echo-ranging effects. The targets ping at a separate, fixed, supersonic frequency, and with a separate fixed ping interval. Consequently, either or both can be tuned in and out in the normal manner by the student's supersonic tuning dial. Pings and their accompanying reverberations can be heard by the student from all directions. The length of time that the reverberation persists increases as the student turns his hydrophone away from the target, and both pings and reverberations attenuate as the range increases. In addition, the intensity of the echo-ranging effects varies randomly to imitate the effects of the target ship pinging on and off the student's submarine. The "echo ranging" controls (red and blue) simply regulate the loudness of this fixed pattern of echo ranging effects.

This control is not coupled in any way with the screw noise selector switch which governs only the type of propeller beat for the target. It is necessary that the instructor take care to turn the echo ranging off when it is inappropriate to the type of target assumed for the problem.

Power switches are located on the student's side, similar to those provided on actual gear for the training mechanism and the receiver. One power switch controls the power to the whole mechanism, while the other switch controls only two pilot lights, one on each side of the machine, and is included for instructional use. A second pilot light on the instructor's side indicates that the main power is on. The machine includes a loud-speaker and has a switch, also on the student's panel, for the selection of phones or speaker. Phone jacks are provided both on the instructor's and student's panel.

SPEED AND COURSE MECHANISM

A separate disc-type variable-speed transmission is provided for each of the three conning stations. For simplicity, only the one for "own ship" is described.

The motor drives a pulley at constant speed against the flat face of a power take-off flange. Adjustment of this pulley radially along the face of the flange provides variable speed at the power take-off. The actual sliding adjustment is accomplished by a rack-and-pinion arrangement which operates in conjunction with the speed-control knob on the instructor's panel. This knob also drives a counter which indicates the ship's speed in knots, a rheostat that is connected in series with the exciter lamp for the photo-electric propeller-beat pickup, and a potentiometer that is in the "own ship's" hydrophone bearing circuit. The variable speed transmission power take-off shaft drives the disc which carries the sound track of the photo-electric propeller beat pickup, and also a "ball mechanism" course-resolving device.

The ball mechanism is a mechanical gadget which translates the ship's speed and course vector into its north-south and east-west components; that is, it converts this vector from polar to rectangular form. The essential elements of the device are three small rollers held in contact with a steel sphere which is supported in such a manner that it is free to rotate in any direction. One roller is driven by the variable-speed drive at a speed proportional to the ship's speed. This roller is carried by a ring which may be rotated to a position corresponding with the ship's course. This driving roller therefore causes the sphere to rotate at a speed and in a direction which are determined by the ship's speed and course

settings. The remaining two rollers are for taking off the converted outputs of the device, and are positioned 90° from the point of contact of the drive roller, and 90° from each other. This position causes the speed of the north and east output rollers to be proportional to the bearing-angle *cosine* and *sine* respectively, of the speed of the driving roller, as shown in the illustrations. Note that if the course-ring is set at 000 heading, the north output shaft will have the same speed and direction of rotation as the driving roller, but that the east roller will not rotate because it touches the sphere at a point which is now its north polar axis.

These output rollers drive differential gear mechanisms which compare target motions to "own ship" motions. For example, the east component of velocity of the "own ship" is subtracted from the east component of Conning A, to resolve relative east rate for Conning A. The output shafts from the differential gear mechanisms also drive cams which operate micro-switches to generate two-phase currents (square wave) from a d-c supply for driving the target motors at their proper speeds and directions, thereby causing the target spots to move accordingly on the viewing screen.

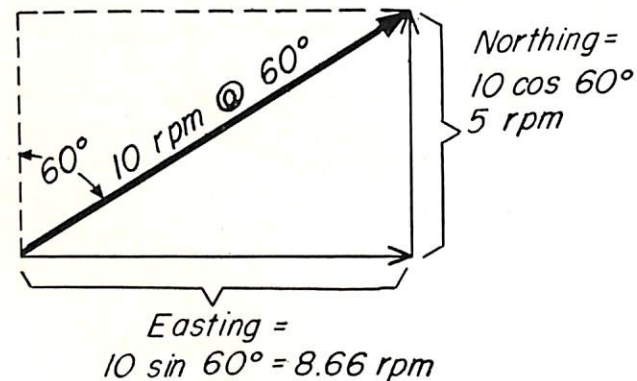
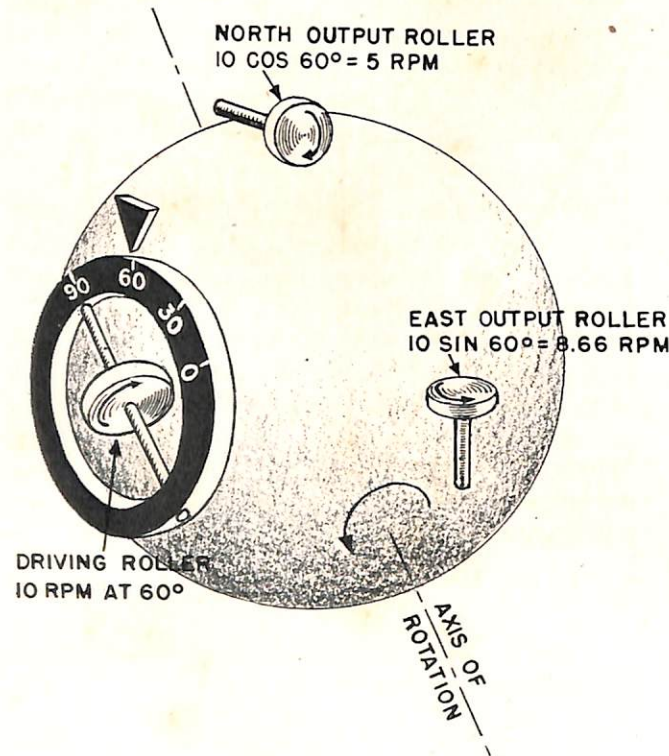

General mechanical arrangement of the ball mechanism which performs the conversion of a polar vector into rectangular form. Here it is used to translate the ship's speed and course into its north and east components. The ball is supported so as to be free to rotate in any direction, this direction being established by the setting of the ship's-course ring which carries the driving roller. Output rollers take off the north and east components of the speed and course. Two positions of the ship's-course ring are shown here and on the opposite page, together with their equivalent vector diagrams.

PHOTO-ELECTRIC PROPELLER-BEAT PICKUP

The propeller-beat pickup for each target ship consists of a photo-electric cell, a transparent disc carrying five sound tracks, and five small exciter lamps. The instructor's screw-noise selector switch energizes the appropriate lamp for each setting. The selected lamp is excited with 24 volt, 60-cycle a.c. so that its light output has a large 120-cycle fluctuation. Consequently the principle cell output is 120 cycles modulated by the sound track, the maximum frequency of which is about 20 cycles per second. The photo-electric pickups are mounted behind the speed and course mechanisms and are driven by the

which is peaked sharply at 100 cycles, amplified and modulated at 100 cycles by a vibrator. This modulated signal which contains, among other things, random noise near zero frequency, feeds two low-pass filter channels. One of these channels delivers random noise up to about 1/2 cycle for producing fading effects in the target noise and echo-ranging circuits, and the other delivers random noise up to about 10 cycles for producing reverberation effects in the echo-ranging circuits. The other low-frequency channel delivers similar fading and reverberation frequencies. Since these two channels will have small but significant differences, and since the input

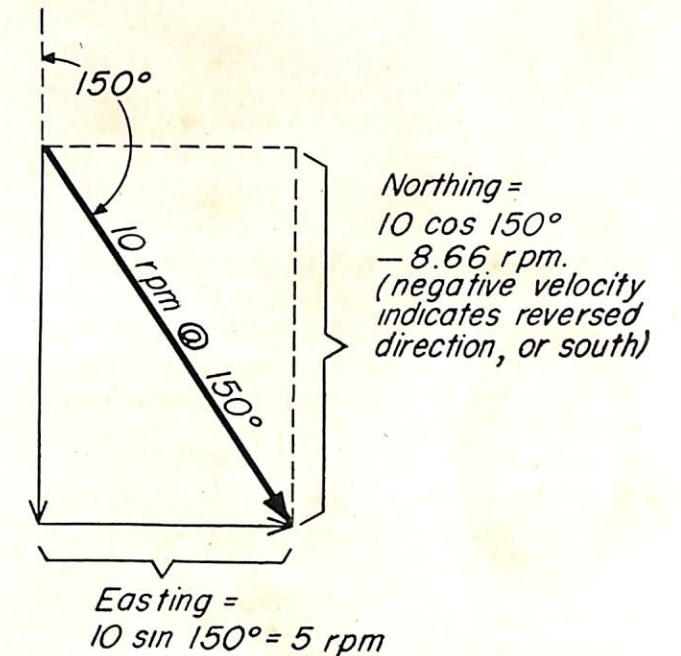
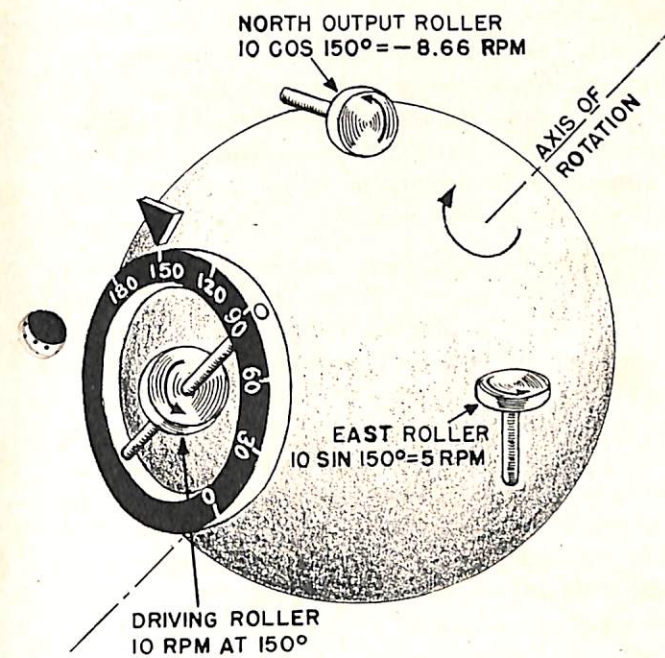

same shaft that drives the corresponding ball mechanism, so that the speed of the propeller beat is proportional to the speed set for the ship. In addition, a rheostat operated by the speed control dims the lamp as the speed is reduced so that the intensity of the ship's noise also reduces with speed. The "own ship" has only one propeller-noise pattern.

NOISE GENERATOR

A 2050 gas tube is used to generate wide-band, random-frequency noise, which is amplified and delivered to separate noise circuits. One of these circuits delivers wide-band noise to the three ships' circuits. Another noise circuit drives two identical noise channels, one of

signal itself lacks regularity, the fading effects from the two channels will not be in step, nor bear any other easily discernible relation to each other. These fading frequencies are used in the target ship-propeller and water-noise circuits, and they are also used in the echo-ranging circuits to produce the effect of the target ship pinging on and off the student's ship. To prevent these two effects from appearing synchronized in one target, the No. 1 fading circuit is used on the red target for noise and for echo ranging in the blue target, and vice versa for the No. 2 fading circuit.

CORRECTION

Page 15, February ELECTRON, fourth line from the top of the page, second column, R-131 should read R-132.

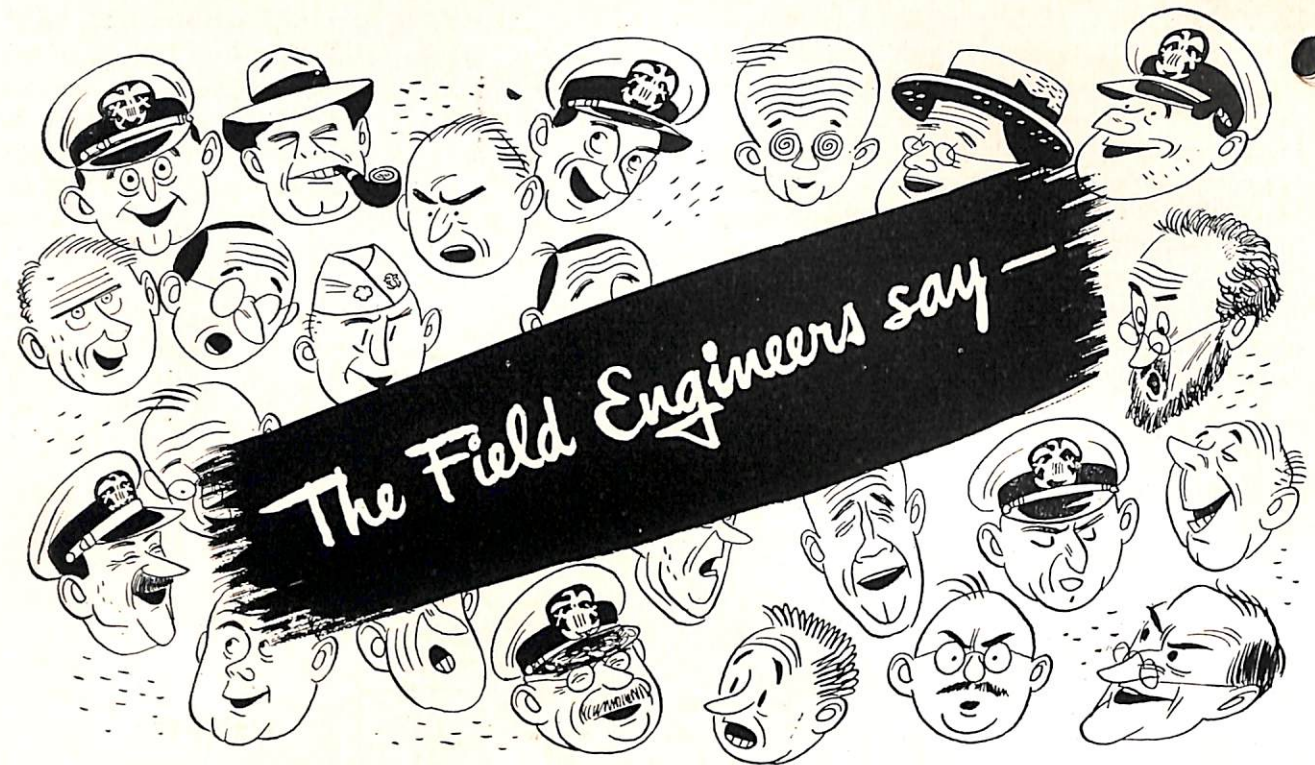

MARK 34 MOD 4—REPELLER VOLTAGE

Several reports have been received of loss of repeller voltage for the local oscillator in the Mark 34 Mod 4 Radar Equipments. A routine voltage check showed that this trouble was due to grounding. Tracing the shielded lead (WH-BL-OR, in cable 301) revealed that the short was at the free end of this lead. This was due to the fact that it is treated as a spare in cable 301 although it actually carries the repeller voltage. Since the wire is a spare, installation crews may not make sure that the shield and center conductor are not in contact at the free end. A simple solution to the problem is to cut the shielded WH-BL-OR lead from the repeller-adjust potentiometer, R-11. This should be done on all Mark 34 Mod 4 installations.

—E.F.S.G.

*

OLD AGE PENSION FOR MAGGIES

Numerous reports have been received which indicate that the tunable type of magnetrons used in SG-series equipments normally have a high mortality rate (very short life) as compared with the fixed-frequency type.

In one particular case eight magnetrons were used over a period of several months and the average life hours of the group was only about 50 hours. Fixed-frequency magnetrons in the same equipments lasted from 700 to 1100 hours. The possibility that eight successive tunable magnetrons were faulty was remote and thus discarded.

A preliminary check of the systems revealed that the driver trigger, modulator pulse, current indications, line

voltage, and all power supply voltages in the driver and modulator were normal. Further checking and testing revealed that relay K-104 was not operating properly and consequently was not inserting any resistance in the magnetron filament circuit. This would cause the magnetron cathode to overheat. Apparently this overheating seriously shortened the life of the tunable types but did not seem to affect the fixed-frequency types. The relay was repaired and a tunable magnetron was installed. This magnetron had operated over 300 hours at the time of this report and was still giving excellent service.

—E.F.S.G.



THE FORUM

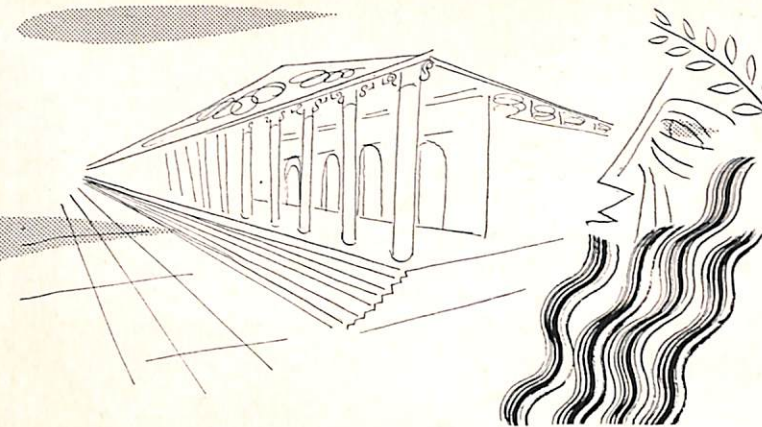

\$64 LORAN QUESTIONS

By LT. ROBERT L. FRANK, Bureau of Ships.

In going about from ship to ship in connection with Loran design matters, many questions are put to me by operating and maintenance personnel. Some of these questions come up so often that I thought ELECTRON readers might be interested in the answers to a few of the most common puzzlers.

Q. In Loran receiving equipment installations, why is a few feet of coaxial cable between antenna and loading coil any more objectionable than the same length of cable between loading coil and receiver?

A. Coaxial cable between loading coil and receiver is terminated in approximately its characteristic impedance, and therefore has a relatively small capacitive shunting effect to ground. On the other hand, coaxial cable between antenna and loading coil is not properly terminated, and acts as a shunt capacity to ground across a relatively high-impedance point. This capacity, together with the antenna capacity, produces a voltage-divider effect and greatly reduces the effectiveness of the antenna.

Q. I noticed a Loran Master station go off the air for about a minute the other day, but the slave station signal remained visible. How is this possible, if the slave station is triggered by the Master?

A. Although the slave station is normally synchronized with the Master, the Slave signal is not actually triggered by the Master but is generated independently. The Master signal as received at the Slave is merely used to make small changes in the Slave pulse recurrence rate, and thus maintain the correct time relationship of Slave-to-Master signal. This arrangement allows the slave to "coast" through momentary static crashes, and provides more reliable operation.

Q. I have noticed that sometimes Loran signals appear to remain synchronized even though the transmitting stations are "blinking". Why is this, and is it safe to use such signals?

A. "Blinking" may indicate, in this case, that the transmitting stations are not sure that their signals are properly synchronized, because of momentary interference or partial failure of equipment. They continue to operate as well as possible so that they can resume normal operation with a minimum of difficulty, but it is evident that when the stations are not sure of proper synchronization, the navigator can't be either, and must not rely on readings obtained while "blinking" occurs.

TBL-8 INSTRUCTION BOOK ERROR

By R. R. Humphrey RT2/C and R. L. Wright RT2/C,
USS Westmoreland (APA-104)

We wish to bring to your attention Paragraph 6.60 (A) of the TBL-8 Instruction Book. In this paragraph, it is stated that no voltage reading will appear on meters M-109, M-110 and M-111 when motor-generator fuses F-401, F-402, F-403 or F-404 are blown. We had fuse F-402 blow and all of the above-mentioned meters read correctly, and the oscillator operated perfectly. However, the indications were identical to the trouble set forth in Paragraph 6.63 of the instruction book. When F-402 blows, screen voltage is removed from the intermediate power-amplifiers and the power-amplifiers, causing the aforementioned indications.

Bureau Comment: This is exactly the type of material the Bureau is anxious to receive from the Fleet. Acting on the information contained in this letter, the Bureau has checked the circuit diagram of the Model TBL-8 and it was found that Paragraph 6.60 (A) is in error. The contractor has been requested to issue an addenda sheet to the Model TBL-8 Instruction Book to correct this error.

The complete QAA equipment is easily carried by one man. Note the hand-held "torch" which contains the crystal transducer.



QAA Portable Echo-Ranging Equipment

The QAA is an extremely light-weight submersible echo-ranging equipment designed to detect and locate small underwater objects such as surf landing obstacles and mines. It gives an approximation of the azimuth and range of an object located from about five to sixty feet distant from the equipment. It was originally designed for use by swimmers of underwater demolition groups while on reconnaissance or during coastal landing operations, and has also proven useful during underwater salvage operations.

The device is small and compact. The entire electronic gear is contained in a case (called a *torch*) 2¾ inches in diameter and 11¾ inches long. The torch, a battery container, and a pair of waterproof headphones make up the entire equipment. The QAA weighs about twenty pounds in air and about six pounds submerged, and can easily be carried by a swimmer.

In operation, the equipment is used much as one would

use a flashlight. The torch is pointed in all directions until a varying audio tone is heard in the headphones. The direction in which the torch points when the tone is loudest is the direction of the object. The highest pitch of the varying tone indicates the range of the object—the *higher* this pitch, the *further* the object from the equipment.

Electronically, the QAA is a frequency-modulated supersonic transmitting and receiving system. Referring to the block diagram, V-1 is a twelve-cycle low-frequency oscillator which drives V-2, a reactance modulator. V-3 is a high-frequency oscillator centered at 500 kc. V-2 causes the output of V-3 to vary sinusoidally between 495.5 kc and 504.5 kc at the rate of twelve cycles per second. This output is fed to a crystal transducer and projected into the water. When these supersonic waves reach a target, some are reflected back to the transducer where they generate a voltage. This voltage and some of

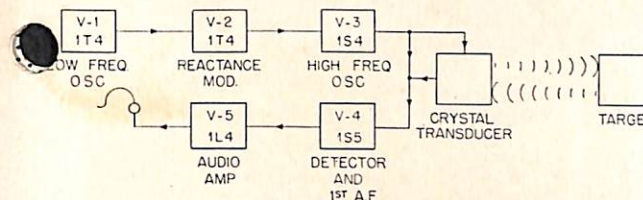

Block diagram of the QAA equipment.

Now consider the case of target #2, which is further from the QAA than target #1. The dotted line of figure 1 represents the echo from target #2. Again assume that the system starts radiating at 500 kc at time A ($t=0$). At time W a 500-kc echo returns. At time W, however, the transmitted radiation has become 504 kc. Both the 500-kc echo and the 504-kc transmitted wave are fed to V-4 and appear in its output as a 4-kc beat

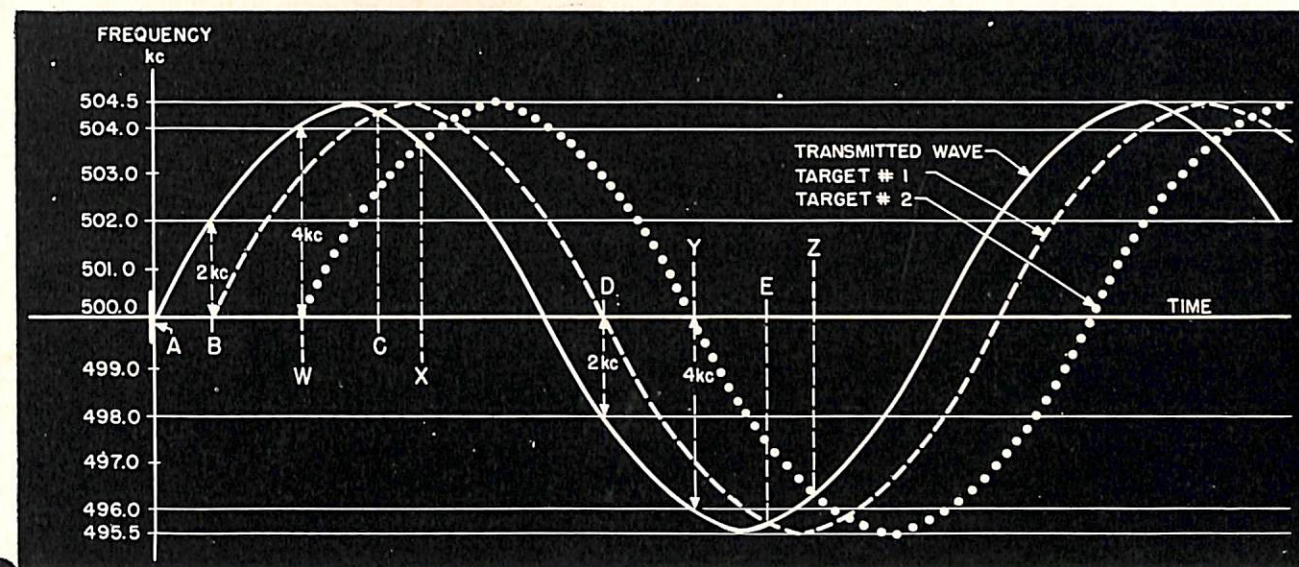

FIGURE 1—Frequency variations of the transmitted output of the QAA and of the echoes from two targets, plotted against time.

the output voltage from V-3 are fed to V-4, which acts as a detector and first audio-frequency amplifier, combining the two voltages and amplifying the audio beat frequency (*difference* frequency) that results. The output of V-4 is resistance-capacitance coupled to V-5, which is the audio output stage of the equipment and drives the headphones.

Figure 1 will help to illustrate the operation of the equipment. The solid line indicates the frequency of the radiated output of the QAA plotted against time; the broken line that of a wave returning from a target (called target #1). Assume that the system started radiating at 500 kc at time A ($t=0$). At time B, a 500-kc echo returns. At time B, however, the transmitted radiation has become 502 kc. Both the 500-kc echo and the 502-kc transmitted wave are fed to V-4 and appear in its output as a 2-kc beat note. At time C, the transmitted wave and the returning echo are both of the same frequency and, therefore, their difference is zero and the audio output frequency of V-4 is zero. At time D, the difference is 2 kc and the audio output of V-4 is again a 2-kc beat note, while at time E the difference is zero and the audio output of V-4 is zero. Thus we see that the audio output of V-4 for target #1 is a varying note with a peak frequency of 2 kc.

note. Thus we see that the audio output of V-4 for target #2 is a varying note with a peak frequency of 4 kc. As is indicated by the results from targets #1 and #2, the higher the maximum frequency of the beat note obtained, the greater the range of the target. This is shown in graph form in figure 2.

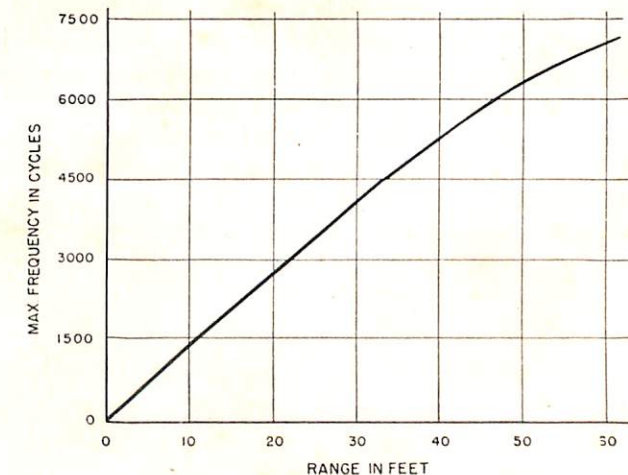

FIGURE 2—Peak audio output of the QAA for target distances of 0 to 60 feet.



Rear view of three parabolic antennas on roof of the Telephone Building, New York City.

PPM—NEW TECHNIQUE

PULSE POSITION MODULATION—RADIO OF THE FUTURE

By FRED SHUNAMAN

Reprinted by permission from Radio Craft magazine

■ A completely new radio signaling system—Pulse Position Modulation—opens up new vistas in both voice and telegraph communication. Differing from AM and FM, it permits multiplexing on a single beam; up to eight channels are being handled simultaneously by one transmitter.

Pulse position modulation, it was revealed recently by Bell Telephone Laboratories who developed the system, was the principle underlying the famous AN/TRC-6 relay radio communications system, used with telling success in the last months of the European war. Pulse-position multiplex communications systems requiring

special cathode-ray tubes to perform the intricate switching operations have already been described. The Bell system—constructed for combat service—uses standard cheap receiver-type tubes for all but the final U.H.F. transmitter and receiver converter tubes. These two are velocity-modulated types, similar to Klystrons.

Pulse-position modulation cannot be classed with either AM or FM, though it resembles the latter type of modulation more closely. Abandoning the carrier wave entirely, PPM carries intelligence on a series of short, sharp, radar-like pulses. In the AN/TRC-6, these are, first a "marker" 4 microseconds in length, followed by

eight 1-microsecond pulses. The sequence is repeated 8,000 times a second, making each series, or "frame" occupy a time period of 125 microseconds, as shown in Fig. 1. Thus each of the 1-microsecond pulses is in the center of a 15-microsecond period, or "channel."

Modulation causes the pulse to occur earlier or later than the middle of the time period allotted to it. If a positive voltage at voice frequency is applied, the pulse will be delayed slightly. If the signal is negative, the pulse will occur before the middle of its time period. The degree of delay or acceleration depends on the amplitude of the voice (or other) signal. Limiting circuits prevent the pulse signal from swinging over more than 12 microseconds of its 15-microsecond space, thus preventing interference with the next channel.

At the receiver end, circuits timed by the "marker" measure the time difference between the start of a modulated pulse and the time it would start if it were unmodulated. Translating that time difference back into signal amplitude, the original voice frequencies are reconstructed.

All eight pulses could be used to handle one transmission, but experience has shown that it is not necessary. A "sampling" of the signal eight thousand times per second by the pulses of one channel is sufficient to transmit voice signals clearly and with excellent telephone quality. Each of the other seven pulses per frame can carry its own transmission.

SIMPLIFIED OUTLINE

A simplified block diagram is shown in Fig. 2. Heart of the circuit is the 8-kilocycle oscillator which originates the marker pulse and triggers the eight channel circuits. Its output goes to the marker generator and marker amplifier to produce the 4-microsecond marker pulse. Meanwhile the oscillator clipper has triggered the channel 8 position modulator, action of which will be considered later. Phone signals from the voice frequency amplifier vary the pulse's position according to the amplitude of the voice signal. It is then passed through a clipper, which ensures that all pulses shall be of the same amplitude, and then is introduced into the main line. There it is further amplified, with the marker pulse

(and the seven other channel pulses) through two more video amplifier stages before being introduced into the transmitter unit, mounted behind the parabolic reflectors of the antenna.

The signal is amplified through two more stages in the transmitter unit, then introduced into the modulator. This tube supplies heavy pulses of power to the velocity-modulated oscillator, which oscillates only when these pulses are applied to it. Since the pulses take up a very small part of the total time (about 12 out of the 125 microseconds in each frame) exceptionally heavy signals can be put out with low average power, as in radar transmitters.

The position modulator is the unit which actually converts speech-actuated voltages into changes in pulse position. It consists of a multivibrator and a pulse generator. The multivibrator consists of the two halves of a 6SL7-GT (V 52 A and B), so biased that free oscillation without outside excitation is impossible. It thus tends to act as an electronic switch. The two cathodes are connected together and grounded through R286 (Fig. 3). Grid of the second section is connected to 300 volts through resistors R284 and R278, and the plate direct to the 300-volt lead. (Resistor and condenser numbers are from the Bell Laboratories blueprints.) Because of the positive grid, this section of the tube draws a heavy current, biasing the cathodes about 50 volts positive because of the heavy current through R286 to ground. Grid of the tube's first section is biased about 35 volts positive with respect to ground by the voltage divider system R270, 378 and 288. It is therefore 15 volts more negative than its own cathode, a bias beyond cut-off for this tube.

Application of the excitation pulse from the oscillator clipper drives the first-section grid far enough positive to permit the tube to pass current. The resulting increased voltage drop across R266 and P8 now causes the plate voltage to drop rapidly, applying a negative voltage to the second section's grid through coupling condenser C120. Plate current of the second section is accordingly reduced and the voltage drop across the cathode resistor R286 falls, reducing negative bias on the first section of the tube, thus permitting it to carry current even after the initiating pulse has ceased.

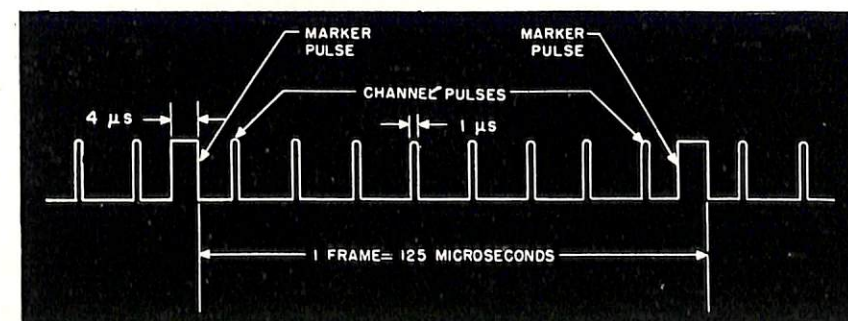

FIGURE 1—Frame of PPM time-division signals.

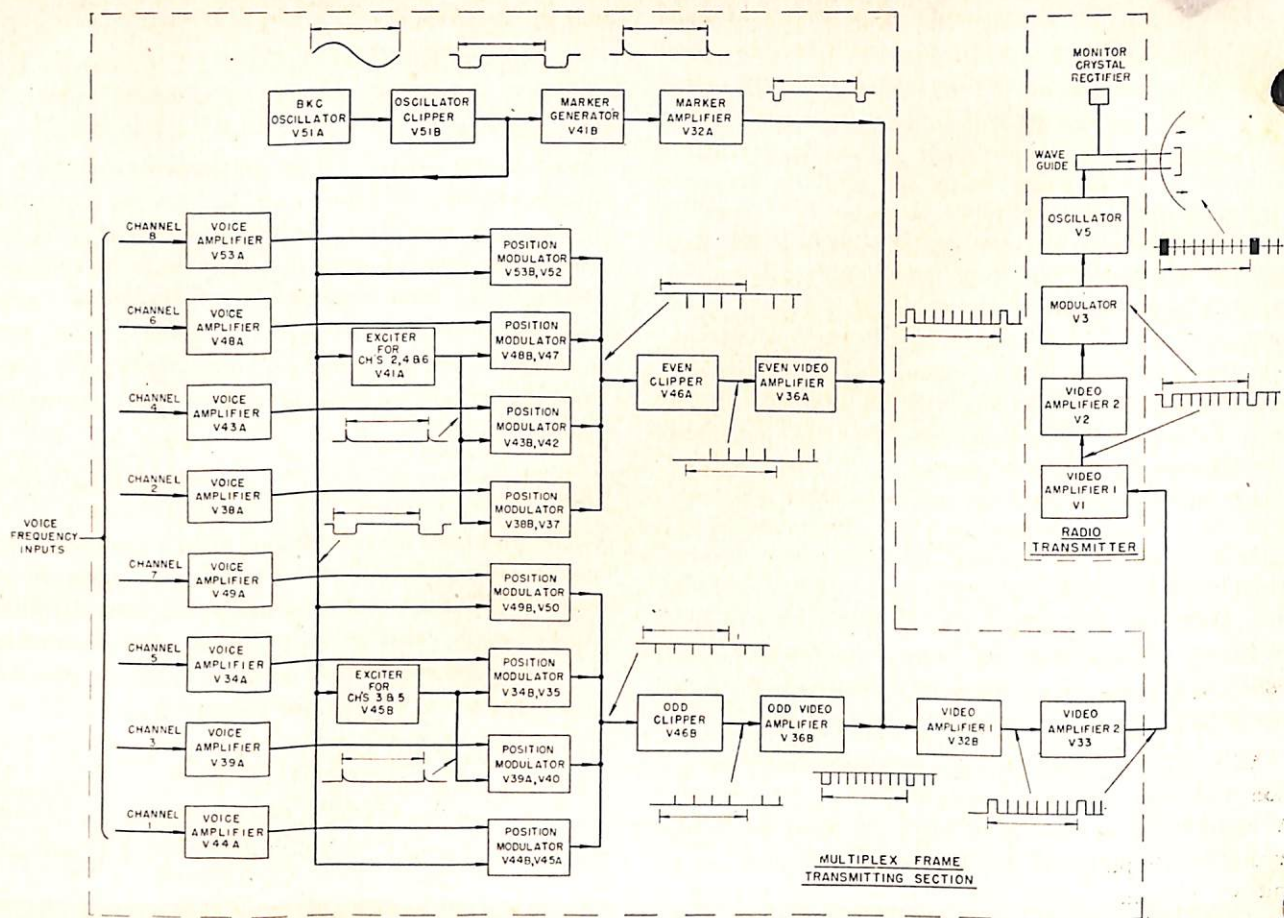

FIGURE 2—Complete block diagram of the transmitter circuits, from voice input to antenna.

Current continues to flow in the first section of the multivibrator tube until the second section grid becomes sufficiently positive to bring the voltage across the cathode up to a point which cuts off the first section. When the first section cuts off, the tube goes back to its original condition with the characteristic suddenness of a multivibrator.

The second section's grid is connected directly to the grid of another 6SL7-GT section, V53B, the pulse generator. During "normal" condition of the multivibrator, this tube draws a small current through the 2.2-megohm resistor (R280) in its plate circuit, due to its positive grid voltage. When the second section of the multivibrator is triggered by the initiating pulse from the oscillator clipper, current flow in the pulse generator tube is cut off and rising plate voltage charges the plate blocking condenser (C126). When multivibrator conditions reverse, the plate voltage drops suddenly as a surge of current passes through the tube. A pulse appears in the output circuit, the exact instant of which depends on the instant of the multivibrator's reversal to "normal." The inductance L₁, which is common to four channels,

together with tube and wiring capacity, fixes the pulse length at about one microsecond.

The instant at which the reversal takes place is dependent on a number of factors, most important of which is the potential applied to the grid circuit of the second section through resistors R278 and R284. Since R278 is also in the voice amplifier plate circuit, instantaneous voltage at the junction of R278 and R284 depends on the amount of current flowing through the voice amplifier tube. If a positive signal is applied to the grid of that tube, current increases and so does voltage drop across R278, reducing the voltage available for application to the multivibrator grid. Hence the multivibrator's snap back to normal will be delayed. If a negative signal is being applied to the voice amplifier grid when the multivibrator is excited, plate current is reduced, voltage is higher and the snap-back and consequent pulse formation takes place at an earlier point than would otherwise be the case.

Variable resistor P8 sets conditions in the multivibrator so that with no modulation the pulse occurs exactly in the middle of its proper channel.

Thus simply is the apparently difficult feat of pulse position modulation performed. Between the pulse generator and the velocity-modulated oscillator which launches it on the ether, the pulse passes (with pulses 2, 4 and 6) through a clipper and a stage of video amplification. The odd pulses are similarly generated and pass through a similar clipper-amplifier. Then the common two-stage video amplifier further builds them up and passes them on to the transmitter unit up on the antenna mast, directly behind one of the parabolic reflectors.

Undergoing two more stages of amplification (through a 6AK5 and a 6V6-GT/G) the signals are applied to the grids of the modulator tube, a 3E29. This is a double beam-tube with both sections connected in parallel, which operates at a plate voltage of 1500. The plates of this tube are connected to the cathode of the U.H.F. velocity-modulated oscillator, driving it into oscillation during the period of each pulse. The U.H.F. signals (at frequencies between 4300 and 4800 megacycles) travel through a hollow wave-guide to a plain reflector at the focal point of the transmitting parabolic reflector, from which they are reflected back against the face of the parabola and sent out in parallel rays to the receiving station, which may be from 30 to 50 miles away, depending on the terrain between the two towers.

PULSE RECEIVING SYSTEM

Arriving at the receiving parabola, the pulses are converged by it onto the reflecting plate at the end of the receiving waveguide and sent down the guide. A frequency 60 Mc lower than the transmission frequency is mixed with the incoming waves in a crystal detector, producing a modulated 60-Mc beat-frequency signal, which is further amplified in a multi-stage i-f amplifier, and detected. From here there is a video signal similar to that in the video stages of the transmitter. This signal is amplified and clipped to eliminate amplitude variations, again passing through a number of stages, and applied to a marker selector.

THE MARKER PULSE

The function of the selector stage is to select the marker pulse from the rest of the incoming signals and use it to operate a series of square-wave generators which supply "gate" pulses in the proper sequence to each of the pulse converter circuits, which convert the position-modulated pulses back to voice frequency.

The method of selecting the marker pulse is simple. The pulses, which at this point have an amplitude of about 10 volts (negative) are applied to the grid of the marker selector tube, V17A in Fig. 4. Its grid, normally

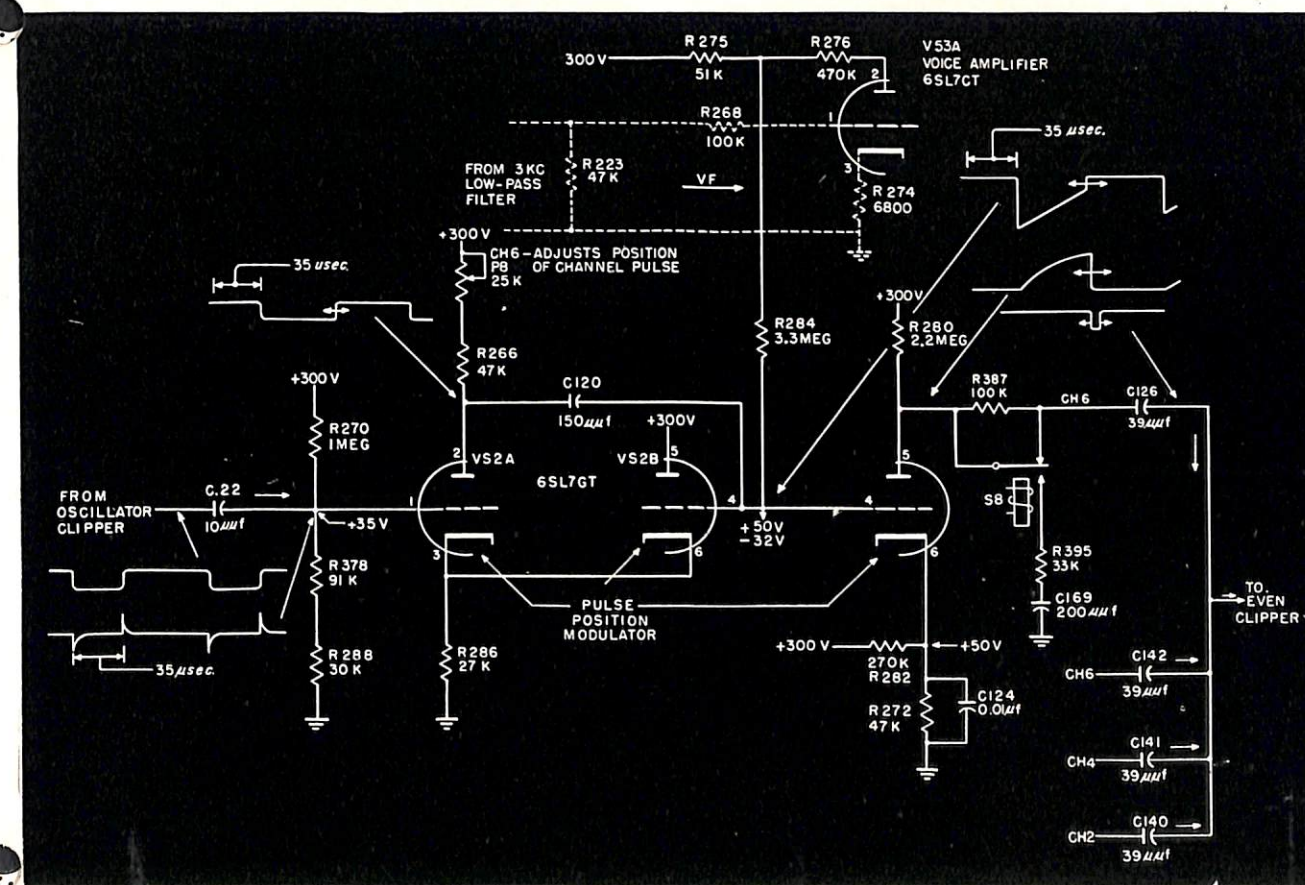
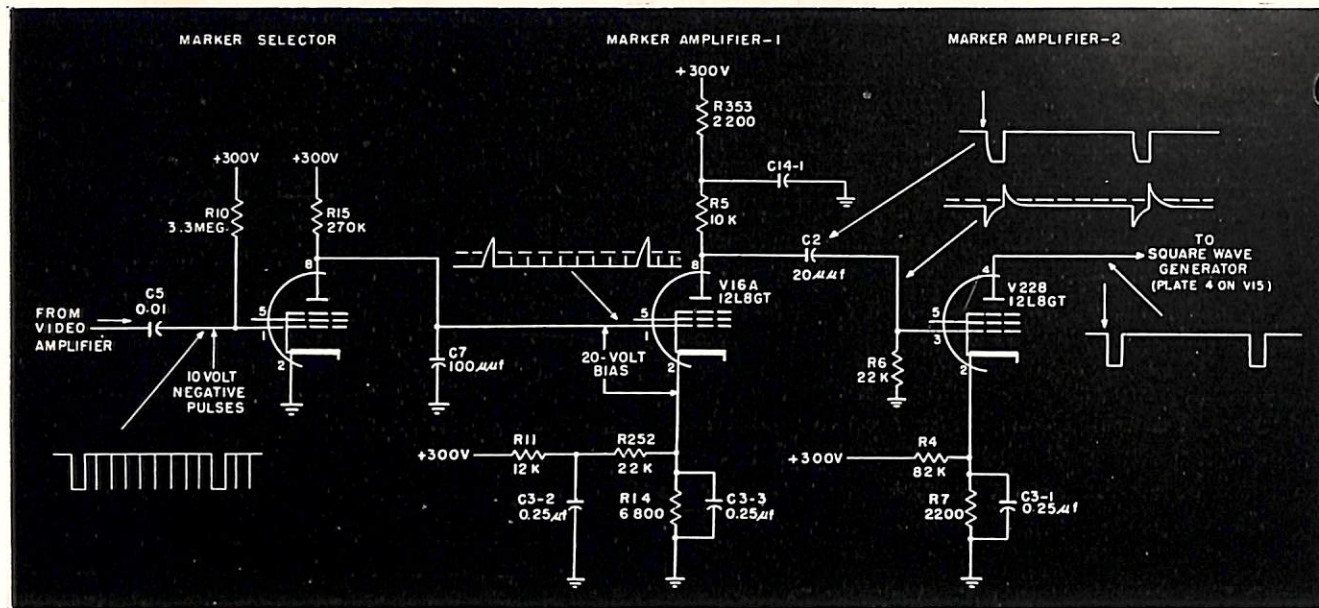
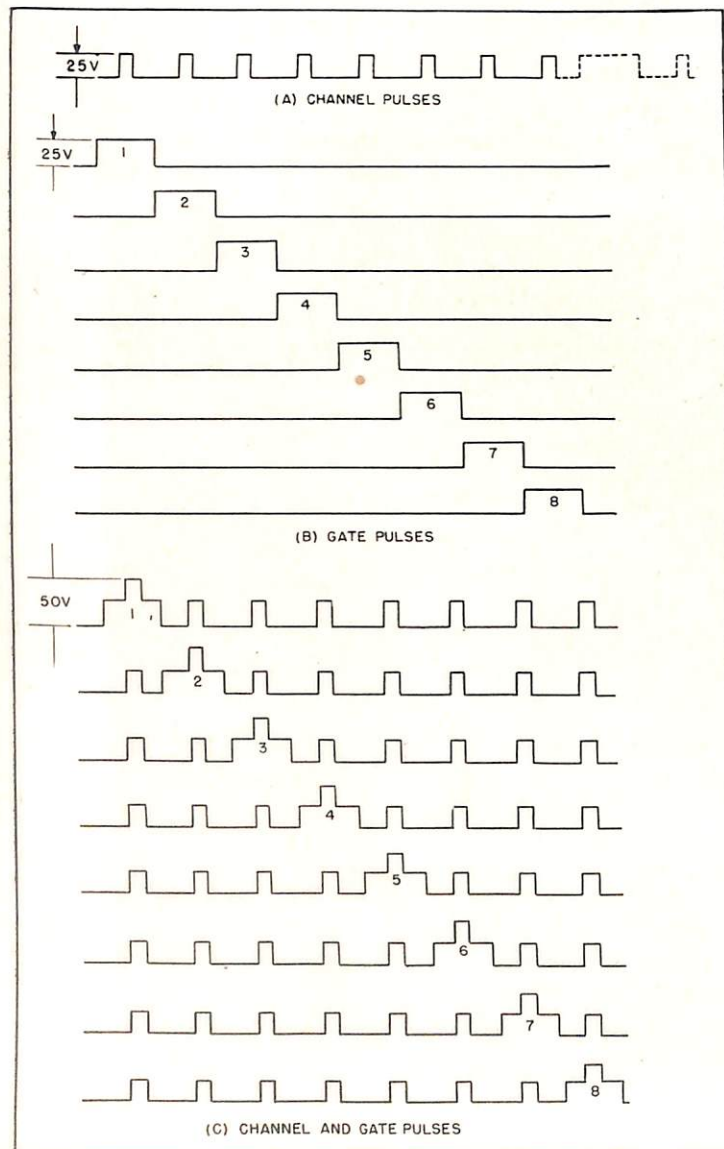

FIGURE 3—The eight position modulators change voice variations to changes in pulse position.



▲ FIGURE 4—Marker selector and amplifier which triggers the receiver circuits into action.



held positive by the 3.3-megohm resistor R10 connecting it to the 300-volt line, is brought below cut-off potential and plate current stops flowing. Plate voltage starts to rise, charging C7 through the 270,000-ohm plate resistor, R15. Since the combination's charging time is relatively long, voltage rise is proportional to the length of the pulses, those of one microsecond producing a rise of about ten volts, while the four-microsecond marker pulse causes a rise of about 40 volts in the plate circuit.

These output pulses are applied to the grid of the marker amplifier tube, which is biased to a point 20 volts below cut-off. Because of this bias, the 10-volt signals from the one-microsecond channel pulses have no effect, while the 40-volt impact of the marker pulse is sufficient to cause plate current to flow and to send amplified pulses on to the square-wave generator. This is a 12L8-GT hooked up as a free-running multivibrator. The amplified marker pulses lock the multivibrator in precise synchronism. Its two plate circuits are connected directly—in the case of two of the eight channels—or through delaying circuits, to the eight gate generators. These produce pulses (called gate pulses) of about 25 volts, 13 microseconds long, so spaced that each one occupies the space allotted to a channel. (See Fig. 5).

THE PULSE CONVERTER

The gate pulses are applied to the eight pulse converters in the order shown in the figure. At the same time, all the channel pulses are applied to all the pulse converters in parallel. The pulse converters are multivibrators, hooked up somewhat like the pulse position

◀ FIGURE 5—Channel plus gate pulse waveforms.

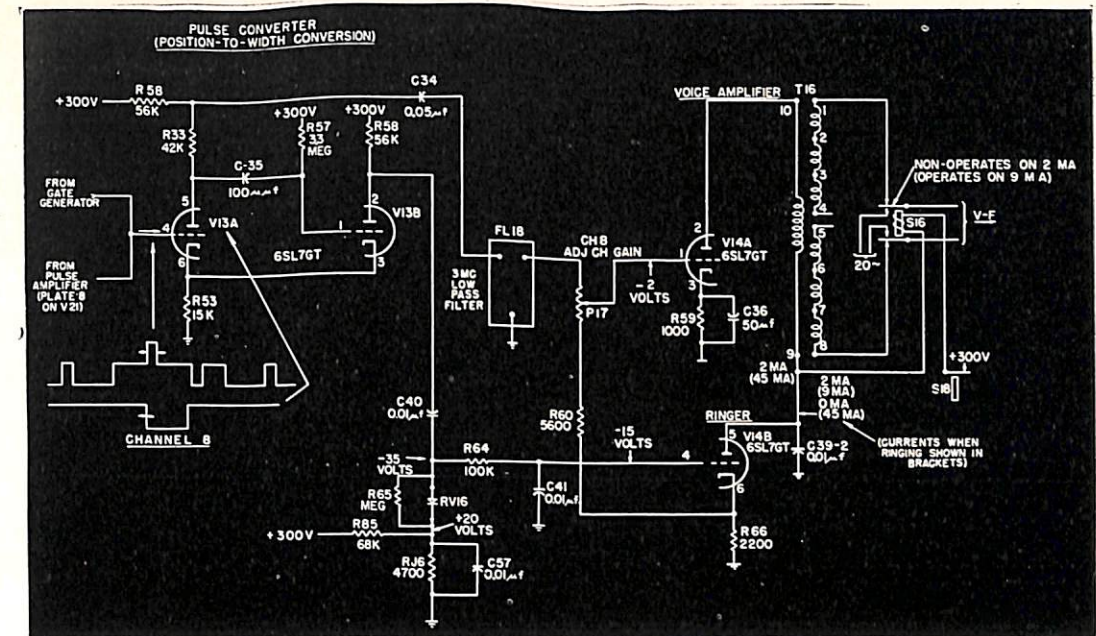

FIGURE 6—Simplified schematic diagram of the pulse converter and voice frequency amplifier.

modulators, whose work they are to reverse. The grid of the first tube V13A (Fig. 6) is connected directly to the plate of its gate generator, as well as to the output of the final pulse amplifier. Its cathode resistor is common to the second section of the tube, whose plate is connected to 300 volts through a 56,000-ohm resistor. The grid of this second section is also brought to the 300-volt positive lead through a 3.3-megohm resistor. The second section therefore conducts heavily, biasing the first section well below cut-off. Channel pulses from the final pulse amplifier are insufficient to overcome this bias. When the gate pulse is applied, the channel pulse added to it is sufficient to drive the first section's grid far enough positive to make the section conduct. Once the first section starts conducting, it continues to do so until the end of the gate pulse.

Thus the output of the pulse converter is a series of pulses of varying length, the rear edge of each pulse occurring at a fixed period, but the leading edge varying at the voice frequency. Thus we have a length-modulated pulse. Since the voltage drop through the 56,000-ohm resistor, R56, and consequently the charges on C34, the output condenser, is dependent on the length of the pulses, it is easy to see that the voltage across C34 varies with the voice signals, rising above and falling below what it would be in the case of an unmodulated signal, as the pulses begin before or after the channel's midpoint.

The output of the pulse converter contains, besides the voice-frequency signal, a strong 8,000-cycle component and its harmonics, together with voice-frequency sidebands of the 8,000-cycle component and its harmonics. It is therefore passed through a low-pass filter, which

removes frequencies above roughly 3,500 cycles, with its attenuation peak at the recurrence frequency of 8,000 cycles. The voice frequencies are then applied to the voice or audio amplifier, from which they go to the common frame of the system, where they may be put on telephone lines or otherwise routed as desired.

OTHER RECEIVER ELEMENTS

The actual receiver circuit is not as simple as has been described. A number of necessary circuits have not been mentioned. One of these is the automatic frequency control circuit, which is hooked in after the eighth i-f stage. This applies to the high-frequency oscillator a voltage which keeps it exactly 60 Mc below the received signal, correcting for slight frequency variations in either transmitter or local oscillator. Operation is along standard a.f.c. lines. When no signal is being received, a searcher circuit is activated, causing the local oscillator to travel over the tuning range till a signal is found, when it locks in on the signal frequency.

An a.v.c. circuit is also provided after the first video amplifier, control voltages being applied to the i-f stages. Two clipper stages also assure uniformity of received pulses.

The gating circuits are also more complex than appears in the simplified discussion. While two gate generators work directly off the square-wave generator, each of the other six channels requires its own sweep generator and gate starter to properly delay gate action so that the eight gate-circuits operate in turn, each occupying its proper portion of the 125-microsecond period.

(All photos and drawings courtesy Bell Telephone Laboratories.)

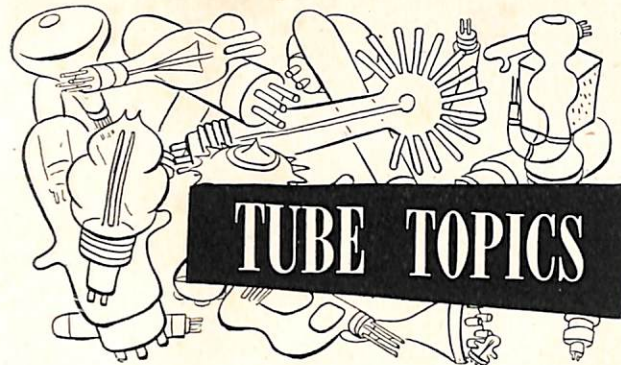

SECURITY OF ELECTRON TUBES

The Bureau of Ships advises that the following tubes with all specifications and technical data pertaining to them are now UNCLASSIFIED:

1B26 1P25A 3J21 4AP10 Z556 Z599
 1B36 2K33 3J30 5J33 Z594 Z647
 1P25 2K50 3J31 6J21 Z597

The Bureau advises that with the exception of tubes used in proximity fuzes, there are no tubes in the fleet or in Navy supplies which are classified.

Preferred List of Army-Navy Electron Tubes as of 1 Nov. 1945

Filament Voltage	Diodes	Diode-Triodes	Triodes	Twin Triodes	Pentodes		Converters	Klystrons	Power Output	Tuning Indicators	Rectifiers	Miscellaneous	
					Remote	Sharp						Cathode Ray	Crystals
1.4	1A3	1S5 (Diode-pentode)	1LE3	3A5	1T4	1L4 1LN5 1S5	1LC6 1R5		3A4 3Q4 3S4			2AP1A 3DP1A 3JP1	1N21B 1N23B 1N25 1N26 1N28 1N31 1N32
5.0										5U4G 5Y3GT/G		3JP7 5CP1A 5CP7A 5FP7A 5FP14 5JP1 7BP7A 12DP7A	
6.3	2B22 6AL5 6H6	6AQ6 6SQ7 6SR7	2C22 2C40 6C4 6F4 6J4 6J5 9002	6J6 6SL7W 6SN7W 7F8	6AB7 6SG7 6SK7 9003	6AC7W 6AG7 6AK5 6AN5 6AS6 6SH7 6SJ7 7W7 9001	6SA7	2K22 2K25 2K26 2K27 2K28 2K29 2K41 2K45 726A 726B 726C	6AK6 6AR6 6AS7G 6B4G 6B4G 6L6WGA 6N7GT/G 6V6GT/G 6Y6G	6AF6G 6E5	6X5GT/G 1005		
12.6	12H6	12SQ7 12SR7	12J5GT	12SL7GT 12SN7GT	12SG7 12SK7	12SH7 12SJ7 14W7	12SA7		12A6	1629			
25 or over									25L6GT/G 35L6GT/G		25Z6GT/G		
Only types for 28 volts anode supply operation		26C6				6AJ5 26A6	26D6		26A5 26A7GT 28D7				

Triodes	Tetrodes	Twin Tetrodes	Pentodes	Pulse Modulation	Magnetrans	Rectifiers			Clipper Tubes	Gas Switching		
						Vacuum	Gas	Grid Control		ATR	TR	
2C26A 2C39 2C43 3C28 CV92 (Br) 100TH 250TH 304TH	450TH 527 811 826 862A 880 1626 8025A	807 813 814 827R 1625	815 829B 832A 4E27 803 837	2E22 2E25 4E27 4C35 5C22 6C21 715C	3D21A 2J30-34 2J41 2J42 2J48 2J49 2J50 2J51 2J53 2J55-56 2J58 2J60 2J61A-62A	4J31-35 4J36-42 4J43-44 4J50 4J51 4J52 4J529 5J25 5J30 5J31 5J32	1Z2 2X2A 3B24W 5R4GY 371B 836 1616 8016 8020	3B28 4B26 4B35 5B21 6C 83 857B 866A 869B 872A 1006	2D21 C5B 6D4 393A 394A 884 2050	3B26 4B31 719A	1B35 1B37 1B44 1B51 1B52 1B53 1B54 1B57	1B23 1B24 1B27 1B32 1B50 1B55 1B58
											Pre-TR 1B38 1B54	Modulators 1B22 1B41 1B42

Receiving types are listed in the upper section, with transmitting types below. The purpose of this list is to effect an eventual reduction in the variety of tubes used in Service equipment. It is mandatory that all tubes to be used in all future design of new equipments under the jurisdiction of the Army laboratories or the Navy department be chosen from this list. Provisions are made for certain exceptions, however, and a procedure has been set up for obtaining permission to use other tubes; for Army equipment, the request should go to the Army Electronics Standards Agency, and for Navy equipment should go to Electronics Division, Bureau of Ships, Code 930-A, Navy Dept.



Don't Let Your Maintenance Bulletins Get Out of Hand!!

Most technicians receive one or more of the Bureau's maintenance bulletins each month. Some of you receive all three— Radar Maintenance Bulletin, Communication Equipment Maintenance Bulletin, Sonar Bulletin. If these monthly correction sheets are filed currently, it's a simple job. It shouldn't take over half an hour. But let them accumulate, and someone will have a major headache on his hands trying to get the right pages in the right places. Keep these Bulletins up-to-date!!

SB

CEMB

RMB

INFORMATION PLEASE!

ELECTRON is *your* magazine! *Your* contributions are a useful source of technical information and news. Through ELECTRON, information received from men out in the fleet is available to all. Write up your contribution and send it directly to us via your C. O. Include sketches or photographs when appropriate.

Address

Editor, BuShips ELECTRON
Bureau of Ships (Code 993)
Navy Department
Washington 25, D. C.

BUSHIPS

Electron